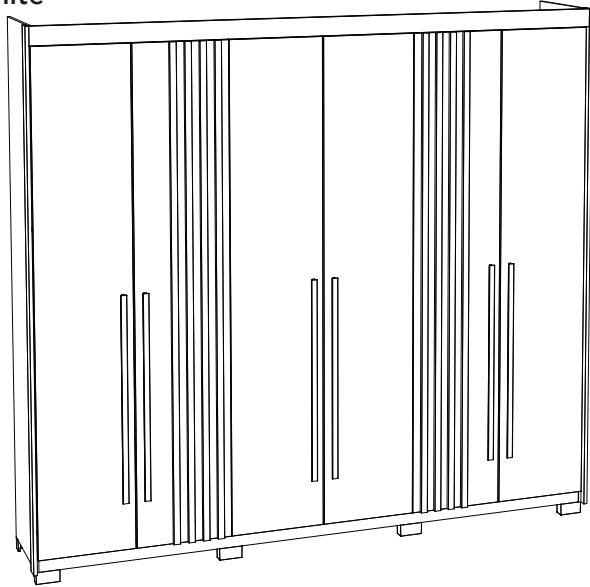
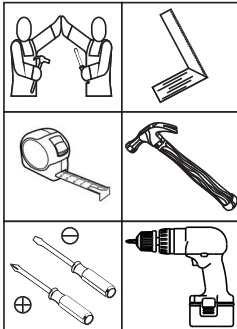

HENNInd. e Com. de Móveis Henn
Mondai - SC - Brasil

☎ +55 49 3674.3500

📧 @moveishenn
www.henn.com.br**INSTRUÇÕES DE
MONTAGEM**INSTRUCCIONES DE MONTAJE
ASSEMBLY INSTRUCTIONS**Roupeiro Norton 6 Portas 4 Gavetas | Armario Norton 6 Puertas 4 Cajones |
Wardrobe Norton 6 Doors 4 Drawers****D325-127 Nature/Off White****D325-128 Nature****Requisitos para montagem
Requisitos para la montaje
Assembly Requirements**

Imagens meramente ilustrativas,
não acompanha o produto.
Imágenes ilustrativas, no incluidas
con el producto.
Illustrative images, not included
with the product.

AVISO

Para limpeza de seu móvel, use uma flanela seca ou umedecida, e não utilize produtos químicos que possam danificar seu produto.

SISTEMA DE MONTAGEM

O sistema de montagem dos produtos, funciona de acordo com a ordem crescente dos números indicados no desenho. Ex: 01, 02, 03, 04... até a conclusão da montagem.

ASSISTÊNCIA TÉCNICA

Para solicitação de Assistência Técnica você consumidor deverá entrar em contato com o Lojista a qual você realizou a compra deste produto e solicitar a assistência técnica das peças avariadas. A garantia abrange todas as peças, partes e componentes que eventualmente venham apresentar defeito de fabricação no prazo de 03 (três) meses, contando a partir da entrega do produto ao consumidor, mediante nota fiscal de compra. Se houver qualquer alteração na estrutura do produto ou ocorrer defeito por negligência do montador/consumidor em relação a instrução de montagem e manuseio, não será fornecido assistência técnica gratuita.

ADVERTENCIA

Para limpeza de su móbil, use una flanela seca o húmeda, y no utilice productos químicos que puedan dañar su producto.

SISTEMA DE MONTAJE

El sistema de montaje de los productos funciona de acuerdo con el orden creciente de los números indicados en el dibujo. Ej.: 01, 02, 03, 04... hasta la conclusión del montaje.

ASISTENCIA TÉCNICA

Para solicitar Asistencia Técnica, el consumidor debe comunicarse con el Comercio que usted realizó la compra de este producto y solicita asistencia técnica para las partes dañadas. La garantía cubre todas las partes, piezas y componentes que eventualmente puedan presentar defecto de fabricación en el plazo de 03 (tres) meses, contados a partir de la entrega del producto al consumidor, mediante factura de compra. Si se produce algún cambio en la estructura del producto o se produce un defecto por negligencia del montador/consumidor en relación con las instrucciones de montaje y manipulación, no se prestará asistencia técnica gratuita.

NOTICE

To clean your furniture, use a dry or wet cloth, and do not use chemicals that may damage your product.

ASSEMBLY SYSTEM

The products' assembly system works according to the increasing order of the indicated numbers. For example: 01, 02, 03, 04 ... to the end of the assembly.

TECHNICAL ASSISTANCE

To request Technical Assistance, the consumer must contact the retailer from whom you purchased this product and request technical assistance for the damaged parts. The warranty covers all parts, parts and components that may eventually present a manufacturing defect within a period of 03 (three) months, counting from the delivery of the product to the consumer, by means of a purchase invoice. If there is any change in the structure of the product or defect occurs due to negligence of the assembler/consumer in relation to the assembly and handling instruction, free technical assistance will not be provided.

ACESSÓRIOS | ACCESORIOS | ACCESSORIES

A



x8

B



x29

C



x8

D



x18

E



x16

F



x54

G



x8

H



x120

I



x64

J

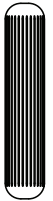

x88

K

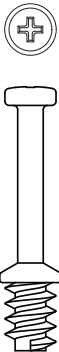

x2

L

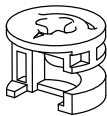

x2

M



x179

N

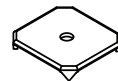

x46

O

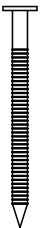

x8

Parafusos em escala
Tornillos escalados
Scaled screws

1:1

ACESSÓRIOS | ACCESORIOS | ACCESSORIES

P



x16

Q

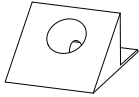

x8

R



x8

S

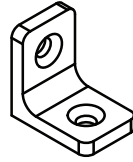

x18

T

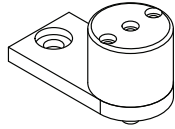

x8

U

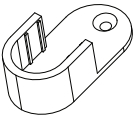

x4

V

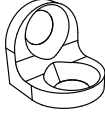

x2

W

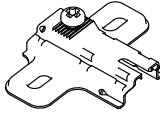

x24

X

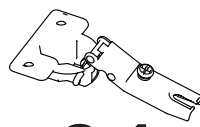

x24

Y

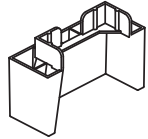

x8

Z

x4_{PAR}

AA

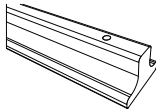

x6

AB

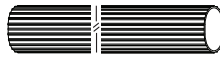

x2

AC



x3

AD



x74

AE

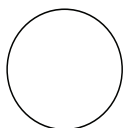

x4

AF

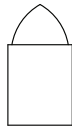

x2

AG



x2

AH

HENN

x1

LISTA DE PEÇAS | LISTA DE PIEZAS | LIST OF PIECES ITM/D325-

Item	Caixa Caja Box	Qty Ctd Qty	Descrição Descripción Description	Dimensões (mm) Dimensiones (mm)		
				Comprimento Largo Length	Largura Ancho Width	Espessura Grosor Thickness
1	2/3	1	RODAPÉ FRONTAL FALDÓN DELANTERO FRONT SKIRTING	2463	73	12
2	1/3	2	TRAVESSA DO RODAPÉ PLACA DE RODAPIÉ SKIRTING PLATE	415	73	12
3	2/3	1	RODAPÉ TRASEIRO REPOSAPIÉS TRASERO BACK FOOTBOARD	2463	73	12
4	2/3	1	BASE BASE BASE	2463	445	12
5	1/3	1	LATERAL ESQUERDA LATERAL IZQUIERDA LEFT SIDE	2250	445	12
6	1/3	1	DIVISÃO ESQUERDA DIVISIÓN IZQUIERDA LEFT DIVISION	1659	445	12
7=13	1/3	1	TAMPO DAS GAVETAS TAPA DE LOS CAJONES TOP OF DRAWERS	813	400	12
8	1/3	1	DIVISÃO DIREITA DIVISIÓN DERECHA RIGHT DIVISION	1659	445	12
9	1/3	3	PRATELEIRA ESTANTE SHELF	813	350	12
10	2/3	1	CHÃO DO MALEIRO REPISA SUPERIOR FLOOR OF MALEIRO	2463	445	12
11	1/3	2	RIPA DO MALEIRO TRAVESAÑO SUPERIOR MALEIRO'S LATH	414	73	12
12	1/3	1	LATERAL DIREITA LADO DERECHO RIGHT SIDE	2250	445	12
13=7	1/3	1	TAMPO DAS GAVETAS TAPA DE LOS CAJONES TOP OF DRAWERS	813	400	12
14	2/3	1	TAMPO SUPERIOR TAPA SUPERIOR TOP PANEL	2463	445	12
15	2/3	1	MOLDURA TRASEIRA MARCO TRASERO REAR FRAME	2486	28	15
16	2/3	2	MOLDURA LATERAL MARCO LATERAL LATERAL FRAME	2250	60	15
17	1/3	4	RIPA LATERAL CINTA LATERAL SIDE RIBBON	395	80	25
18	2/3	1	MOLDURA SUPERIOR MARCO SUPERIOR TOP FRAME	2486	80	15
19	2/3	1	FUNDO SUPERIOR FONDO TOP TOP FUND	2483	431	3
20	2/3	6	FUNDO FONDO BOTTOM	1675	410	3
21	3/3	4	PORTA PUERTA DOOR	2112	409	15
22	3/3	2	PORTA COM APLIQUE PUERTA CON APLICARSE DOOR WITH APPLY	2112	409	15
23	2/3	8	APLIQUE APLICARSE APLLY	2112	28	15
24	1/3	4	FRENTE DE GAVETA FRENTE DE CAJÓN FRONT OF DRAWER	755	192	12
25	2/3	8	LADO DE GAVETA LADO DEL CAJÓN SIDE OF DRAWER	350	122	12
26	1/3	4	FUNDO DE GAVETA RECORTADO FONDO DEL CAJÓN RECORTADO CROPPED DRAWER BOTTOM	725	361	3
27	1/3	4	RIPA DE TRÁS MALLA DETRÁS REAR LATH	738	122	12

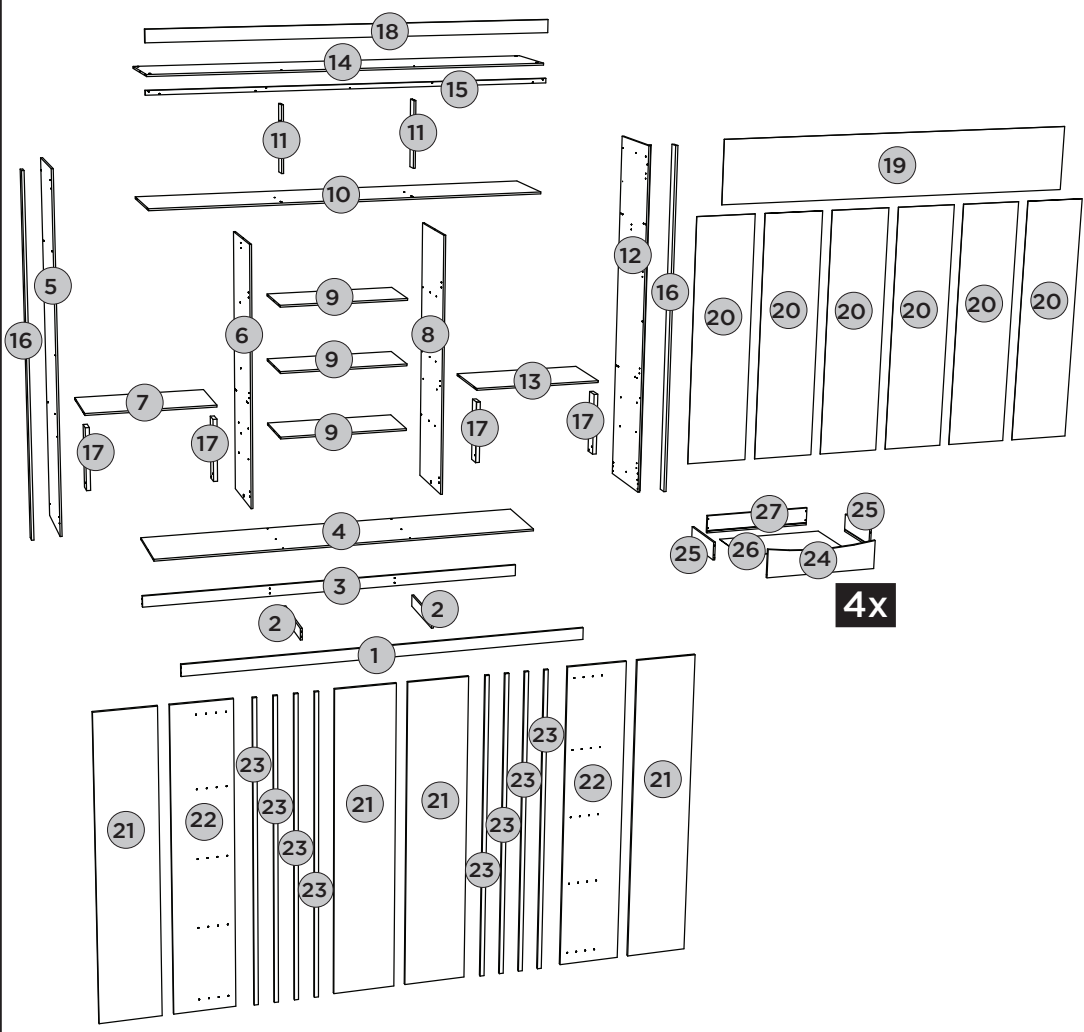





PASSO 1

ITM/D325-

PEÇAS REQUERIDAS

1	RODAPÉ FRONTAL	x1
2	TRAVESSA DO RODAPÉ	x2
3	RODAPÉ TRASEIRO	x1
11	RIPA DO MALEIRO	x2
18	MOLDURA SUPERIOR	x1

ACESSÓRIOS REQUERIDOS

H		06
J		20
S		04
V		02

FERRAMENTAS NECESSÁRIAS

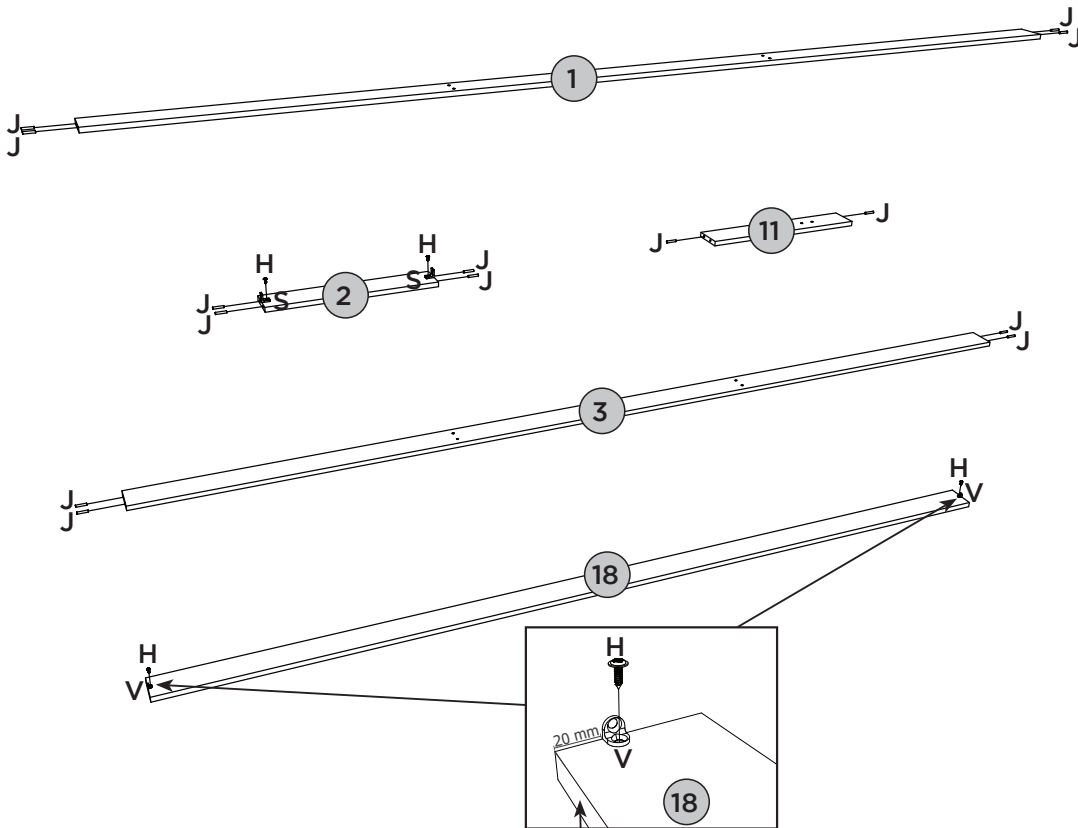
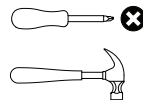

Lado sem borda

Lado sin borde

Side without border

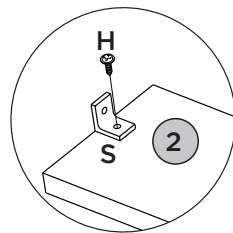
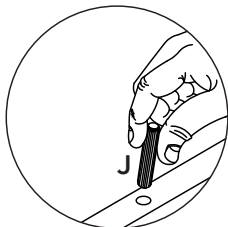



PASSO 2

ITM/D325-

PEÇAS REQUERIDAS

4	BASE	x1
7=13	TAMPO DAS GAVETAS	x2
9	PRATELEIRA	x3
10	CHÃO DO MALEIRO	x1
14	TAMPO SUPERIOR	x1

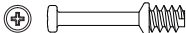
ACESSÓRIOS REQUERIDOS

J		28
K		02
R		08



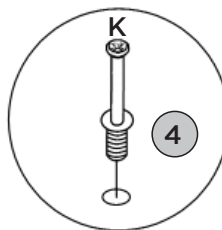
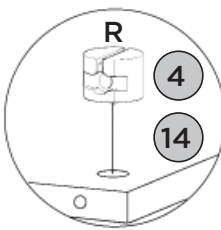
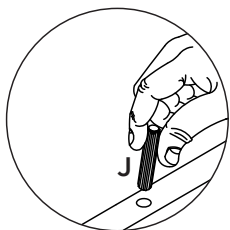
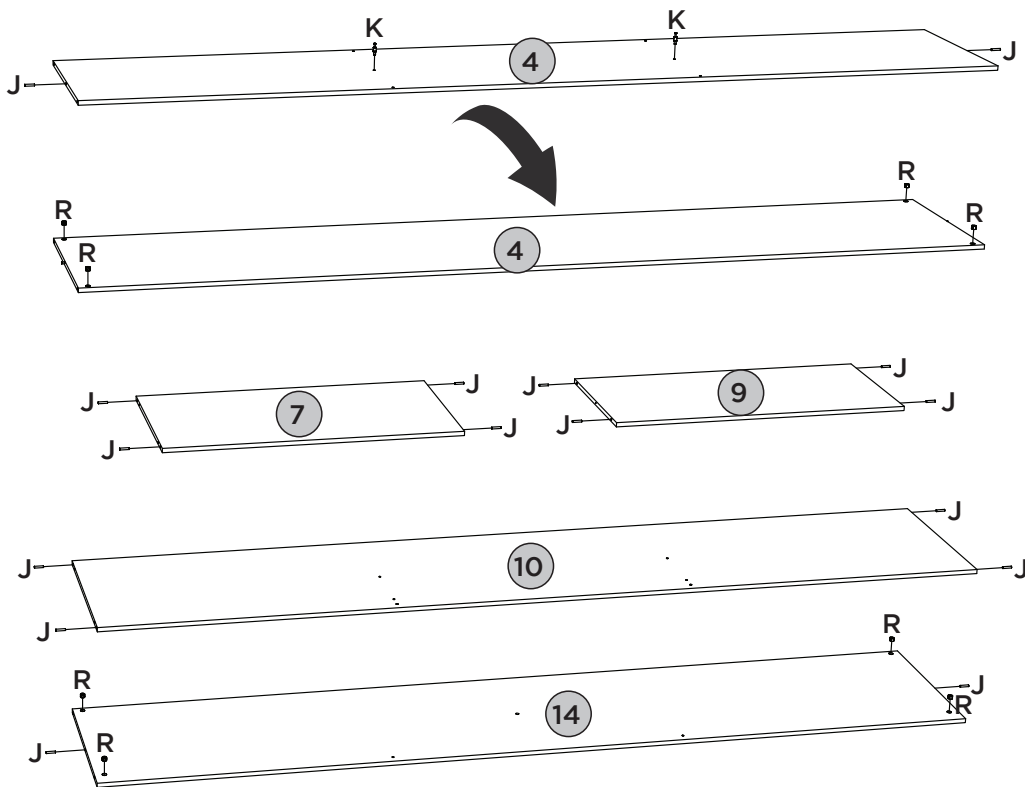
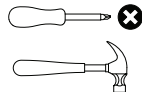



FERRAMENTAS NECESSÁRIAS



PEÇAS REQUERIDAS

5	LATERAL ESQUERDA	x1
6	DIVISÃO ESQUERDA	x1
8	DIVISÃO DIREITA	x1
12	LATERAL DIREITA	x1

ACESSÓRIOS REQUERIDOS

H		24
I		08
J		08
T		08
U		04
W		08

FERRAMENTAS NECESSÁRIAS

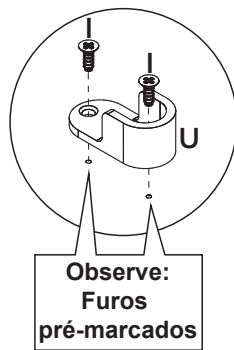
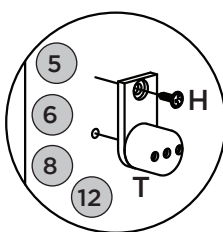
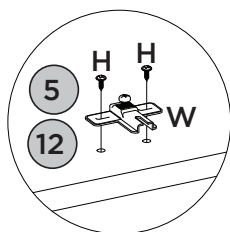
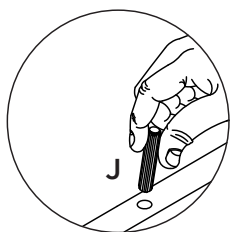
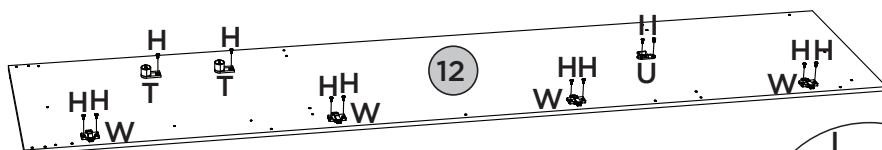
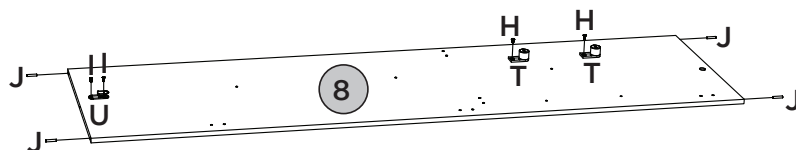
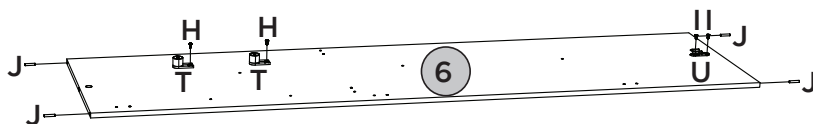
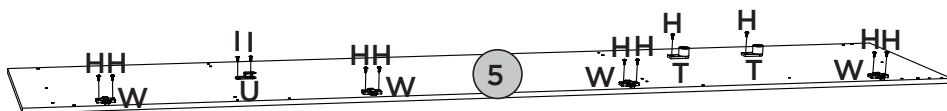
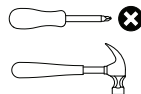

PASSO 4

ITM/D325-

PEÇAS REQUERIDAS

1	RODAPÉ FRONTAL	x1
2	TRAVESSA DO RODAPÉ	x2
3	RODAPÉ TRASEIRO	x1

ACESSÓRIOS REQUERIDOS





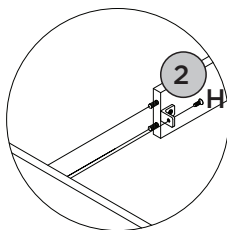
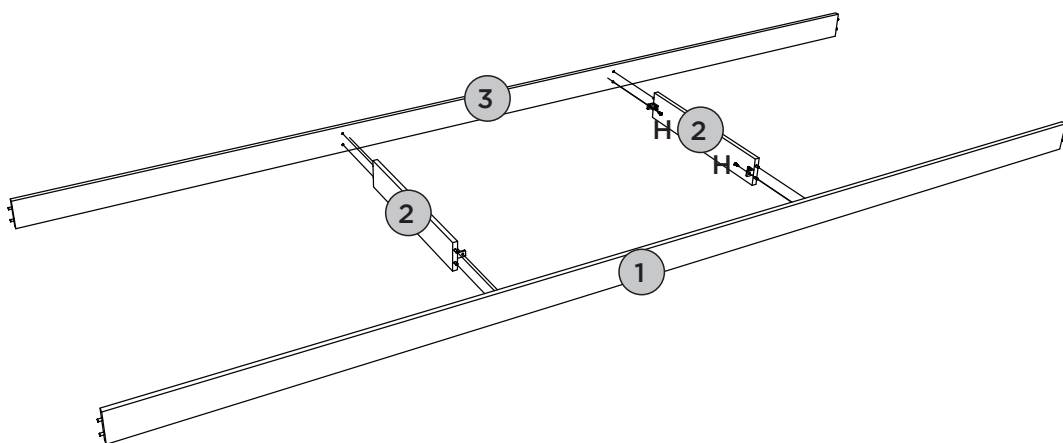
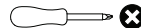



FERRAMENTAS NECESSÁRIAS



PEÇAS REQUERIDAS

4	BASE	x1
5	LATERAL ESQUERDA	x1
6	DIVISÃO ESQUERDA	x1
7	TAMPO DAS GAVETAS	x1

ACESSÓRIOS REQUERIDOS

A		02
B		04
H		36
L		01
S		06
Y		08

FERRAMENTAS NECESSÁRIAS

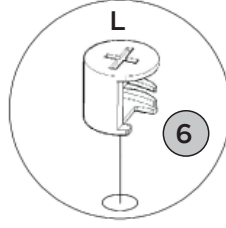
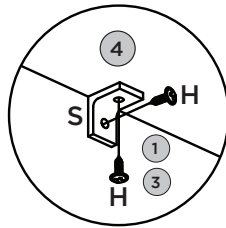
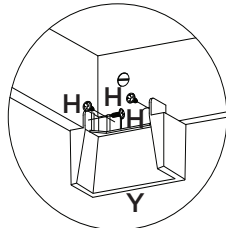
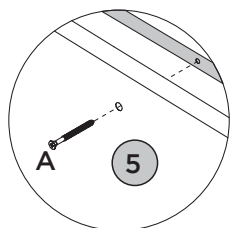
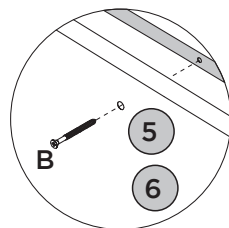
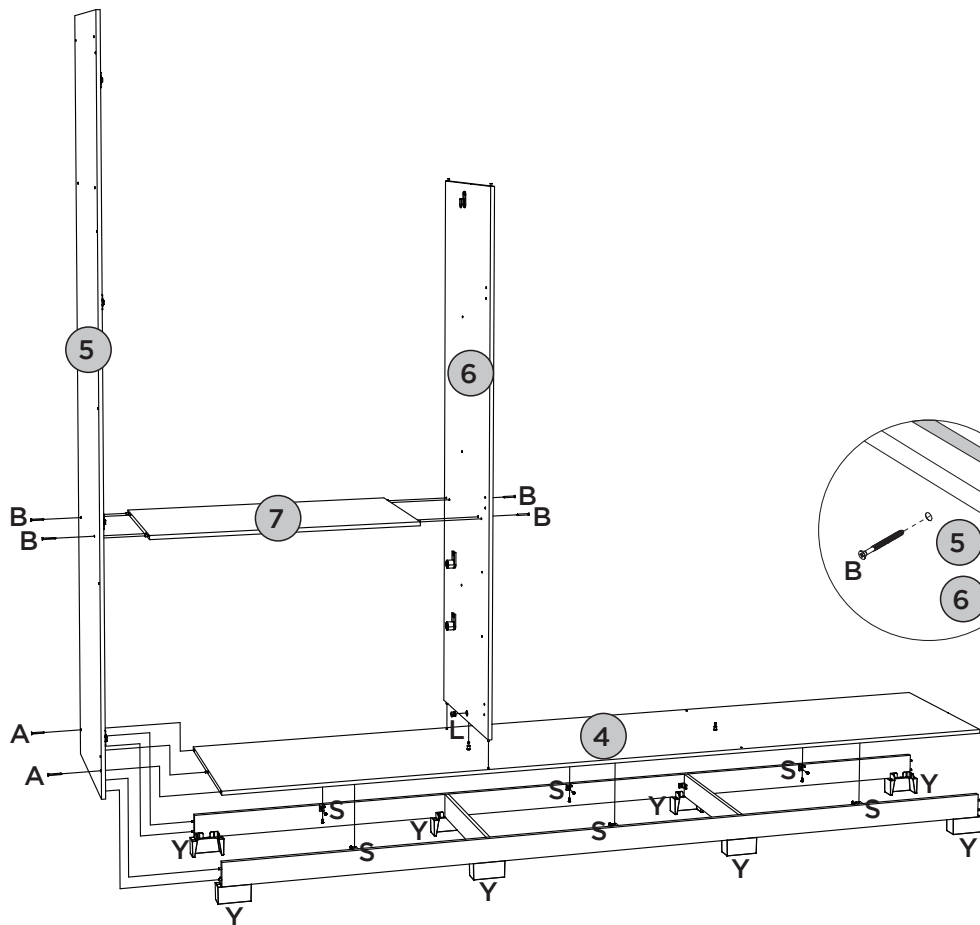
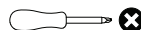



PASSO 6

ITM/D325-

PEÇAS REQUERIDAS

8	DIVISÃO DIREITA	x1
9	PRATELEIRA	x3

ACESSÓRIOS REQUERIDOS

B		06
L		01



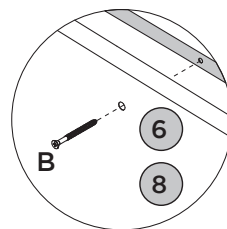
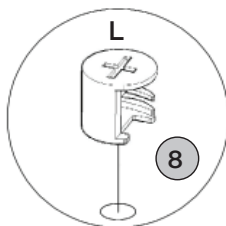
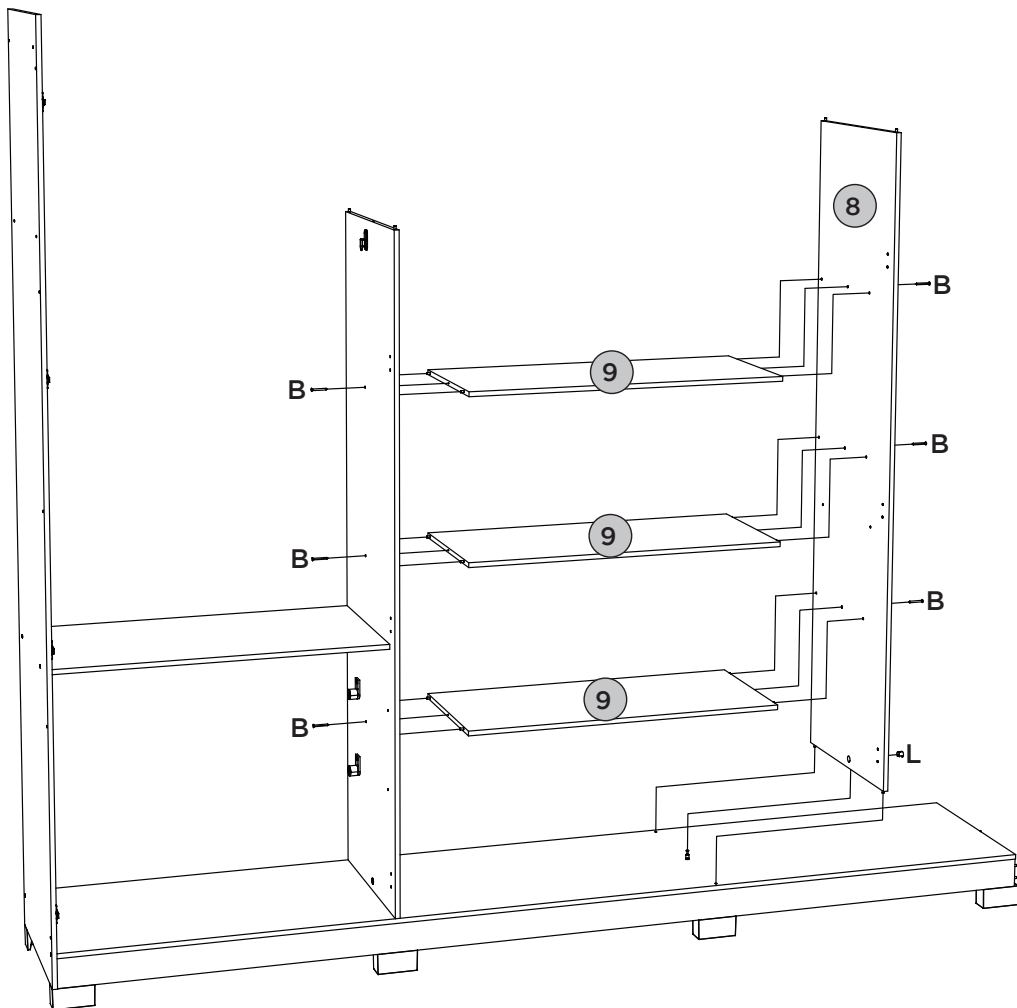
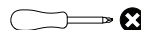

FERRAMENTAS NECESSÁRIAS



PEÇAS REQUERIDAS

10	CHÃO DO MALEIRO	x1
11	RIPA DO MALEIRO	x2
12	LATERAL DIREITA	x1
13=7	TAMPO DAS GAVETAS	x1
14	TAMPO SUPERIOR	x1

ACESSÓRIOS REQUERIDOS

A			06
B			14

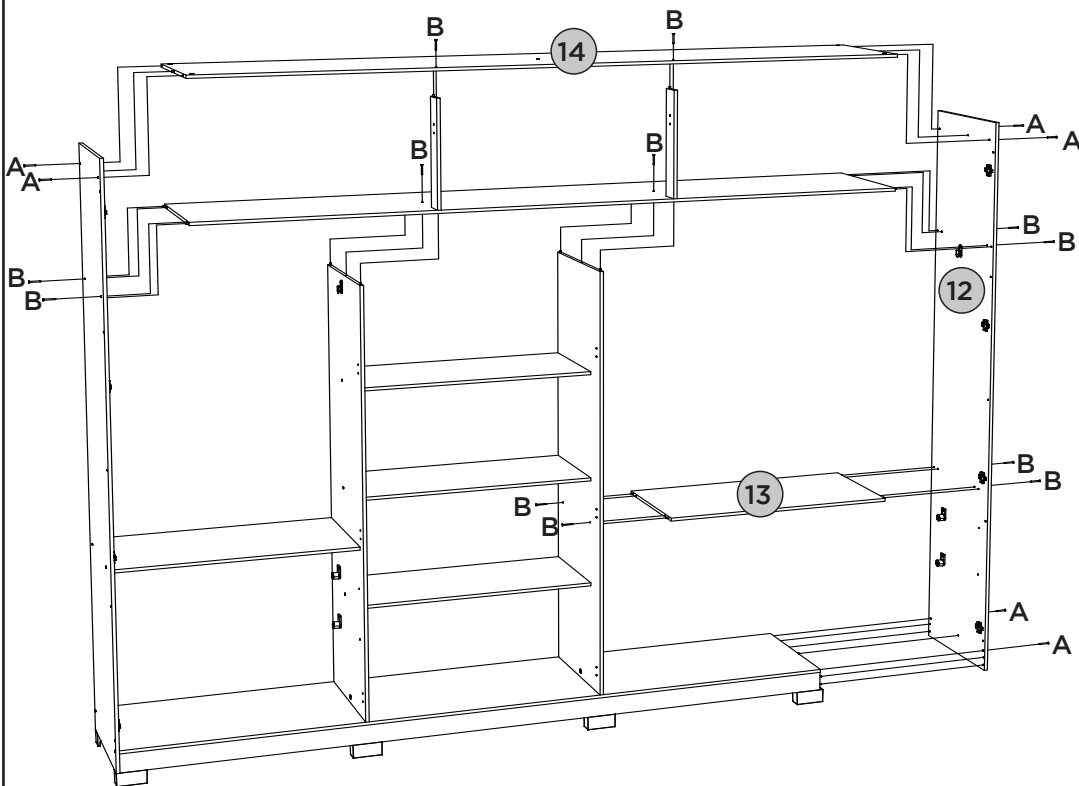
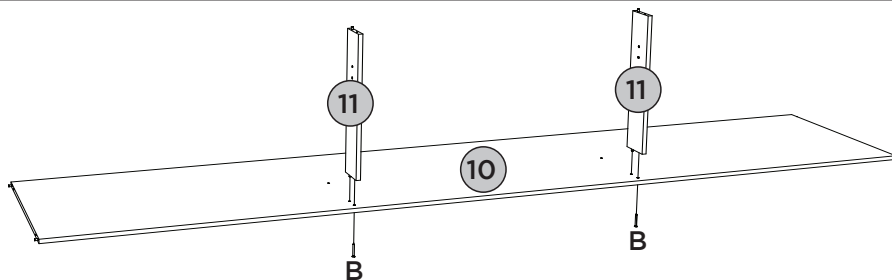
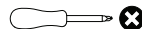

FERRAMENTAS NECESSÁRIAS



PEÇAS REQUERIDAS

15	MOLDURA TRASEIRA	x1
16	MOLDURA LATERAL	x2
17	RIPA LATERAL	x4

ACESSÓRIOS REQUERIDOS

B		05
C		08
F		10

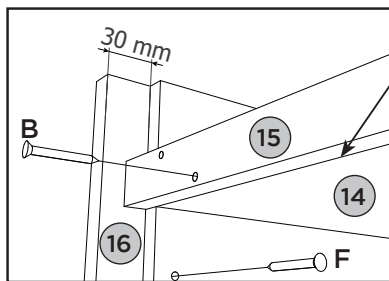
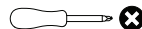
FERRAMENTAS NECESSÁRIAS

Alinhar a Moldura Traseira (15) com o Tampo Superior (14).

Alinee el Marco Trasero (15) con la Parte Superior superiores (14).



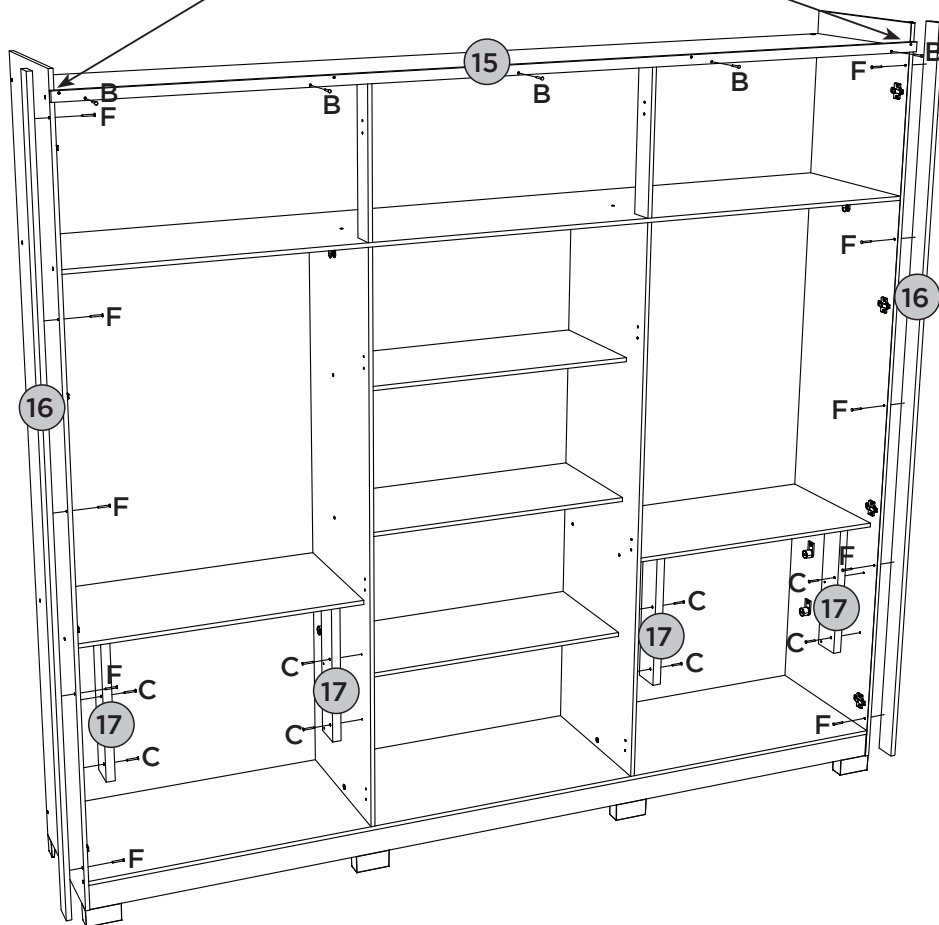





Align the Rear Frame (15) with the Top Superior (14).

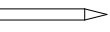

PEÇAS REQUERIDAS

18	MOLDURA SUPERIOR	x1
19	FUNDO SUPERIOR	x1
20	FUNDO	x6

ACESSÓRIOS REQUERIDOS

F			04
H			02
M			179
N			46
AC			03

FERRAMENTAS NECESSÁRIAS

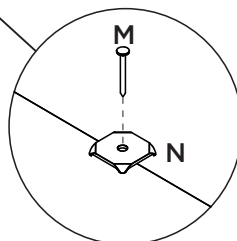
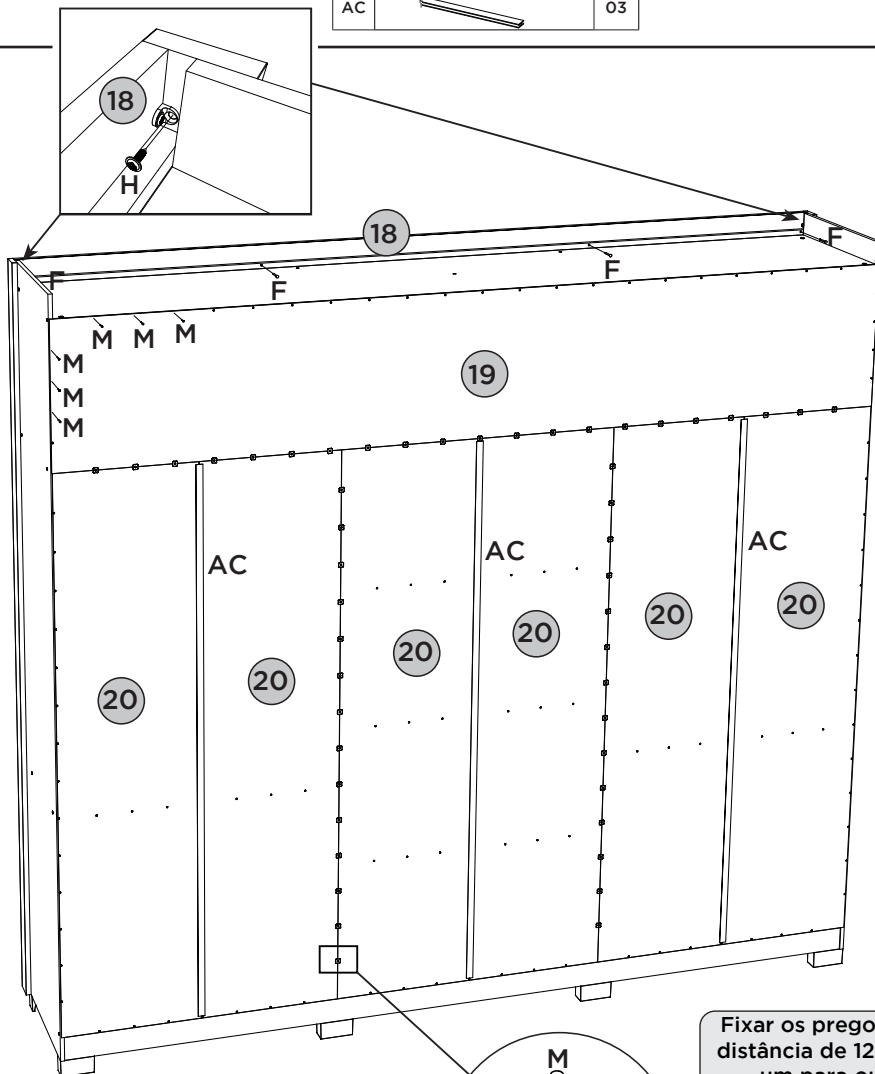
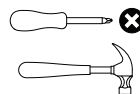

Fixar os pregos a uma distância de 120mm de um para outro.

Fijar las uñas a un distancia de 120mm uno a otro.

Fix the nails at a distance of 120mm from one to the other



PASSO 10

ITM/D325-

PEÇAS REQUERIDAS

21	PORTA	x4
22	PORTA COM APLIQUE	x2

ACESSÓRIOS REQUERIDOS

H		48
X		24

FERRAMENTAS NECESSÁRIAS

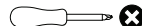

4x

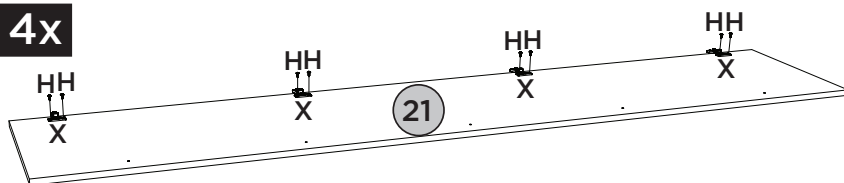

2x

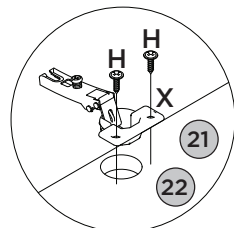
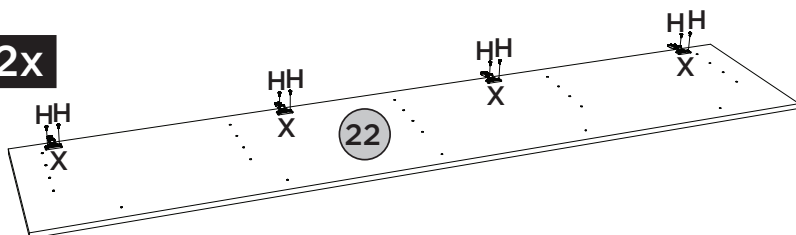

Vídeo: Instalar e regular Dobradiças

Video: Instale y ajuste las bisagras

Video: Install and adjust hinges

PASSO 11

PEÇAS REQUERIDAS

22	PORTA COM APLIQUE	x2
23	APLIQUE	x8

ACESSÓRIOS REQUERIDOS

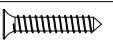
F		40
---	--	----

FERRAMENTAS NECESSÁRIAS





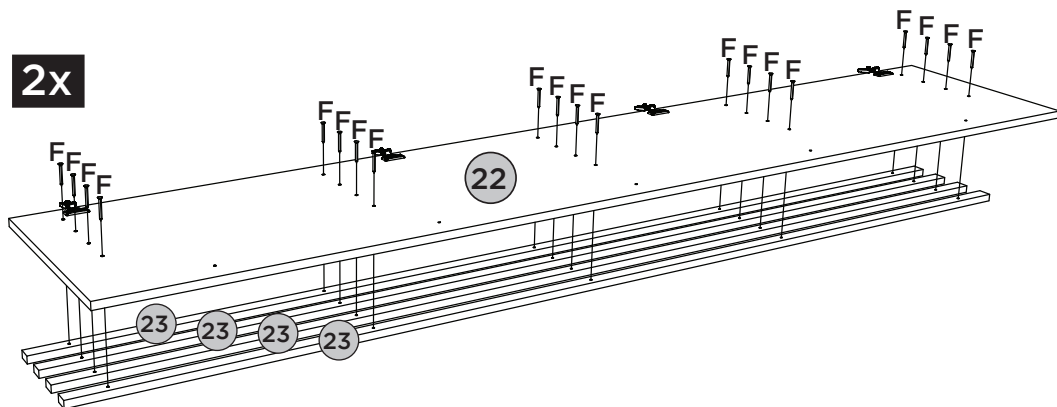





2x



PEÇAS REQUERIDAS

21	PORTA	x4
22	PORTA COM APLIQUE	x2

ACESSÓRIOS REQUERIDOS

D		18
E		16
I		16
P		16
W		16
Z		04
AA		06
AB		02

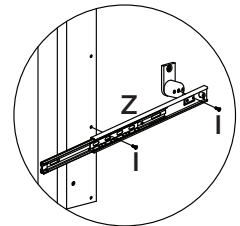
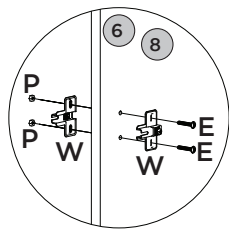
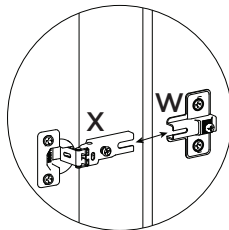
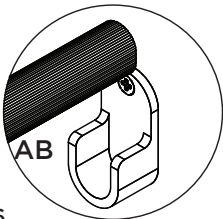
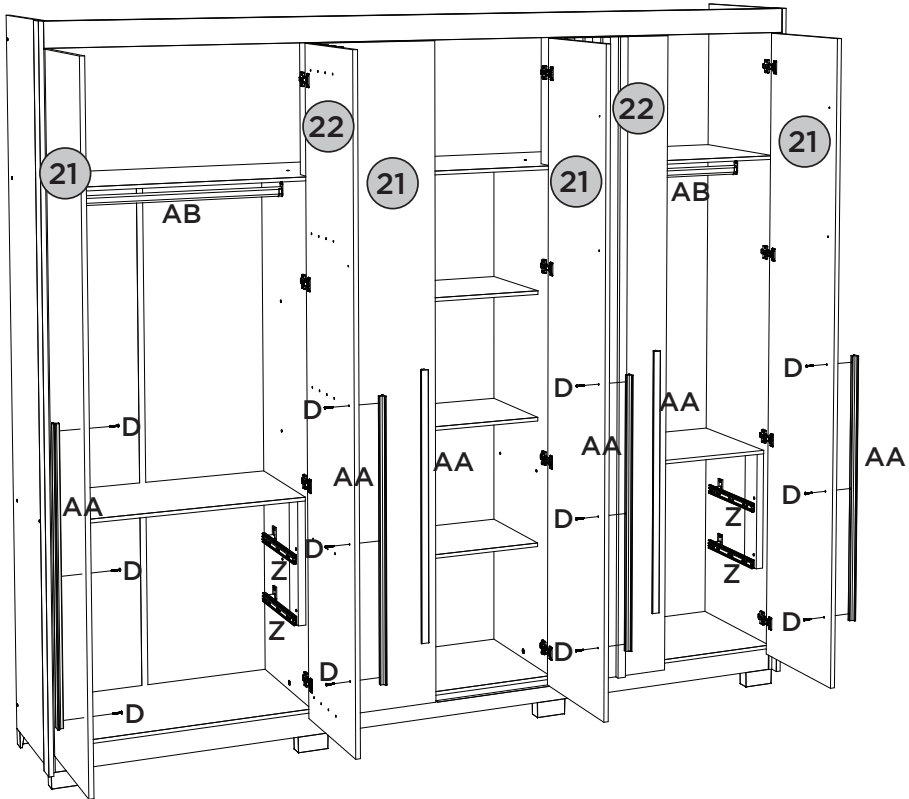
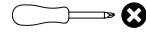

FERRAMENTAS NECESSÁRIAS



PASSO 13**PEÇAS REQUERIDAS**

25	LADO DE GAVETA	x8
----	----------------	----

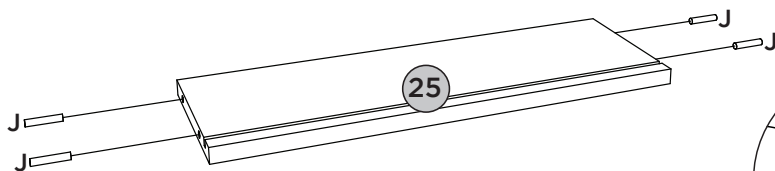
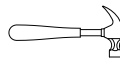

ACESSÓRIOS REQUERIDOS

J		32
AG		

FERRAMENTAS NECESSÁRIAS**PASSO 14****PEÇAS REQUERIDAS**

24	FRENTE DE GAVETA	x4
25	LADO DE GAVETA	x8
26	FUNDO DE GAVETA RECORTADO	x4

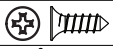
ACESSÓRIOS REQUERIDOS



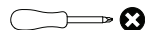
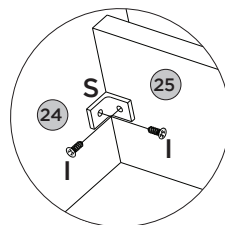
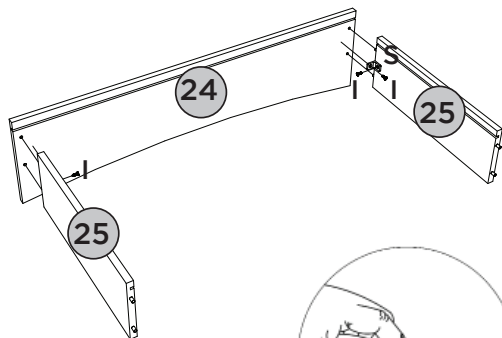
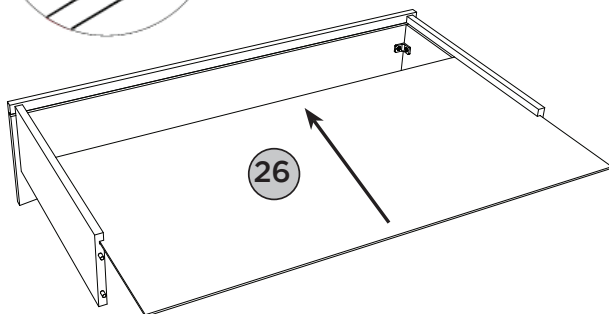







I		16
S		08
AG		

FERRAMENTAS NECESSÁRIAS**4x****1º****4x****2º**

PEÇAS REQUERIDAS

27	RIPA DE TRÁS	x4
----	--------------	----

ACESSÓRIOS REQUERIDOS

G			08
I			24
O			08
Q			08
Z			04
AG			

FERRAMENTAS NECESSÁRIAS

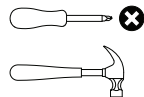
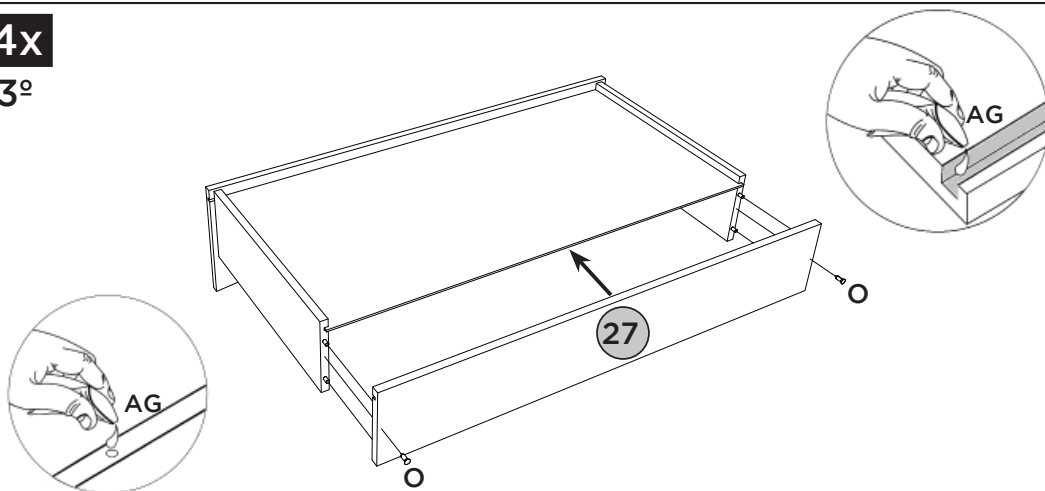
4x
3º

4x
4º

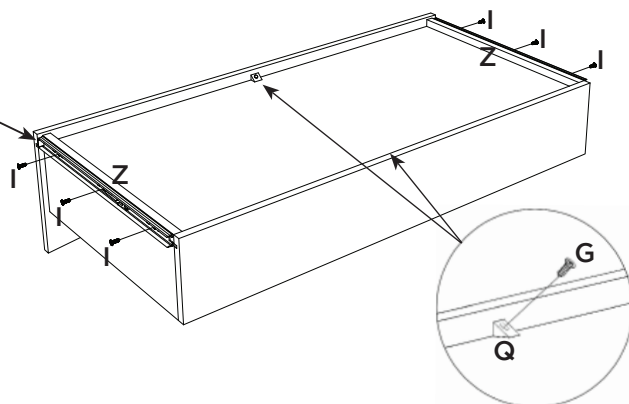

Deixar 3mm de distância da frente de gaveta.

Deje una separación de 3mm del frente del cajón.

Leave 3mm away from the front of the drawer.



ACESSÓRIOS REQUERIDOS

AD		74
AE		04
AF		02
AH	HENN	01

Pesos máximos recomendados com carga distribuída
 Peso máximo recomendado con la carga distribuida
 Recommended maximum weight with distributed load.

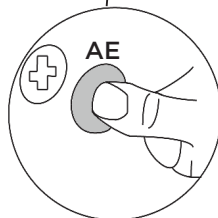
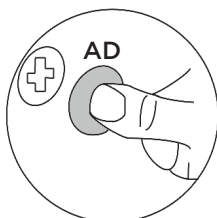
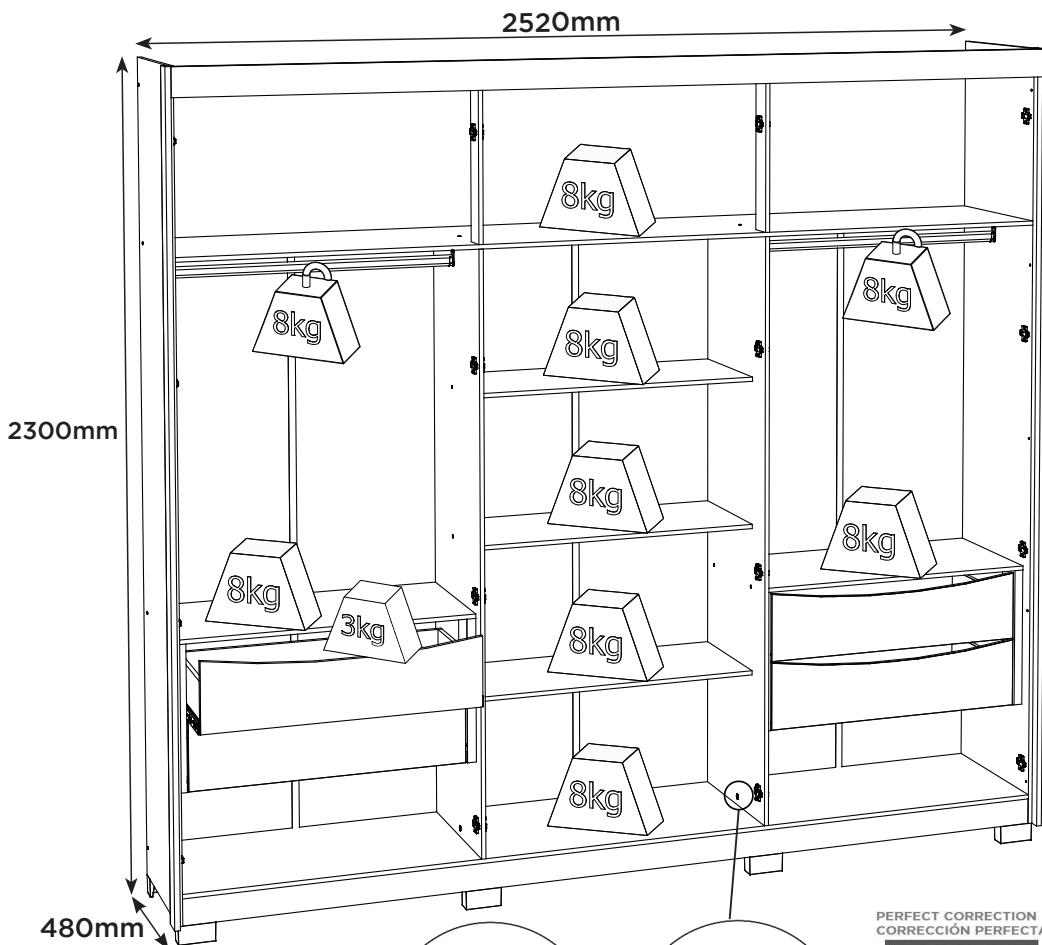

PERFECT CORRECTION
 CORRECCIÓN PERFECTA

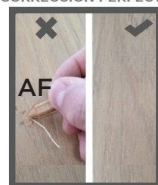

Produto Concluído
Producto terminado
Finished Product

