

RELAÇÃO DE PEÇAS

3 Passo
Paso
Step

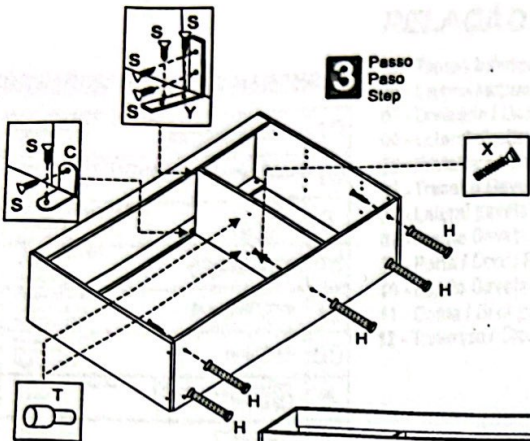

4 Passo
Paso
Step

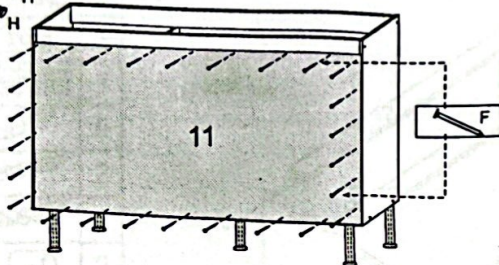

5 Passo
Paso
Step

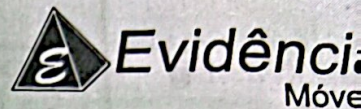
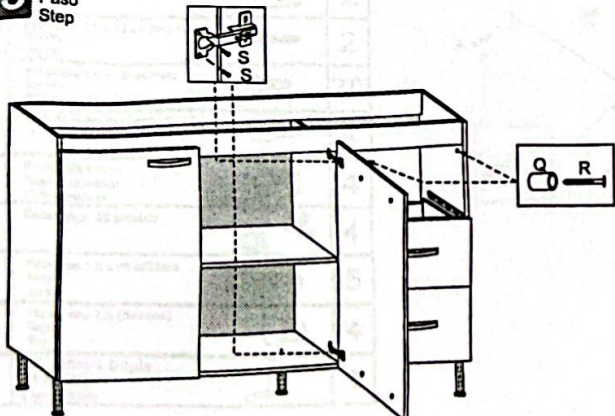











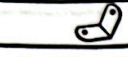

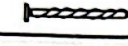



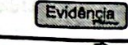

MANUAL DE MONTAGEM
INSTRUCCIONES DE ARMADO
ASSEMBLY INSTRUCTIONS

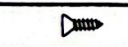
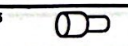
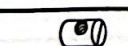

BALCÃO PARA PIA

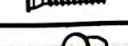
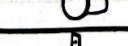
PARAFUSOS/HERRAJE/HARDWARE

Parafuso 3,5 x 40 c/Chata Tornillo Screw		10
Parafuso 3,5 x 25 c/Rançada Tornillo Screw		10
Cantoneira 18x18 Esquina Cantoneira		7
Cavilha 6 x 30 Clavija Wood Peg		14
Preço 13 x 18 Clavo 13 x 18 Nail 13 x 18		12
Preço 10 x 10 Clavo 10 x 10 Nail 10 x 10		60
Capeta de cozinha Tenedor Hand		5
Cola Adesivo Glue		1
Cliqueta epoximérica Evidência		1
Extractor 96 mm Extractor Wrench		5
Corrediza plástica Plastic runner Slider		2
Corrediza plástica Plastic runner Slider		4
Capeta Screwdriver Wrench		2
Parafuso 3,5 x 20 c/Rançada Tornillo Screw		2
Parafuso 3,5 x 12 c/Chata Tornillo Screw		70
Capeta Screwdriver Wrench		4
Capeta Screwdriver Wrench		4
Capeta Screwdriver Wrench		4
Parafuso 7,0 x 40 c/Chata Tornillo Screw		5
Capeta Screwdriver Wrench		4
Capeta Screwdriver Wrench		4
Capeta Dupla Capeta Wrench		1

RELAÇÃO DE PEÇAS

- 01 - Tampo Inferior / Lower top / Tapa inferior
- 02 - Lateral esquerda / Left side / Lateral izquierda
- 03 - Divisória / Divider / Divisória
- 04 - Lateral direita / Right side / Lateral derecha
- 05 - Prateleira / Shelf / Estante
- 06 - Traseiro Gaveta / Drawer back / Traseiro del cajón 3x
- 07 - Lateral gaveta / Drawer side / Lateral del cajón 6x
- 08 - Frente Gaveta / Drawer front / Frente del cajón 3x
- 09 - Porta / Door / Puerta(2)
- 10 - Fundo Gaveta / Drawer bottom / Fondo del cajón 3x
- 11 - Costa / Back panel / Dorso (2x)
- 12 - Travessa / Crossbar / Travessaño 2x

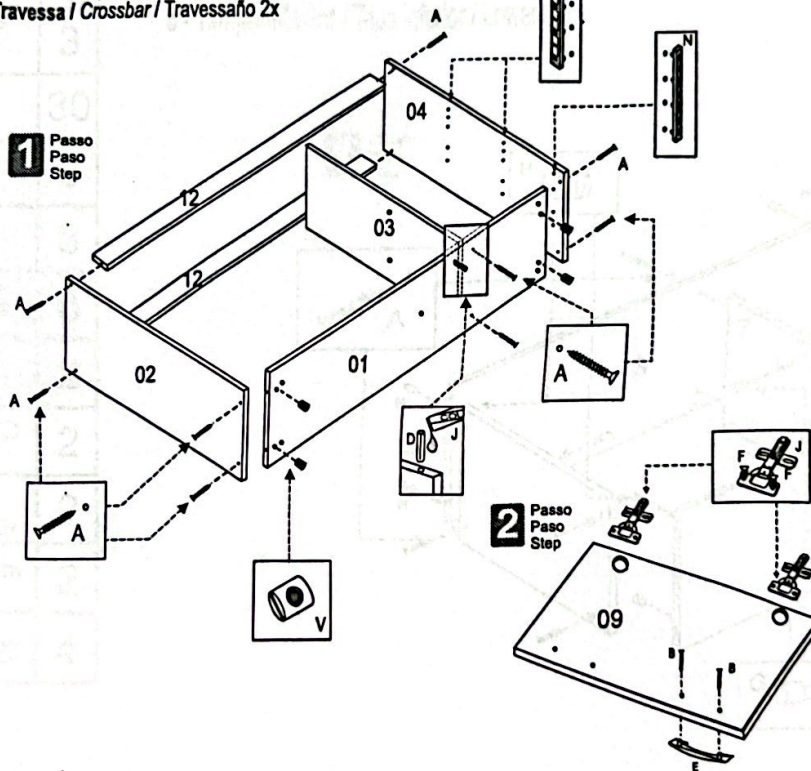
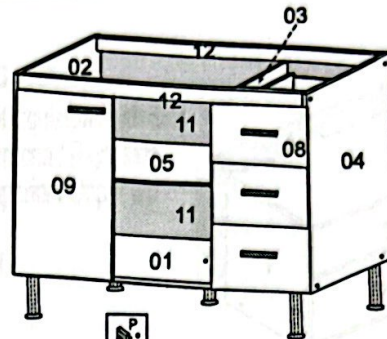

MONTAGEM GAVETA

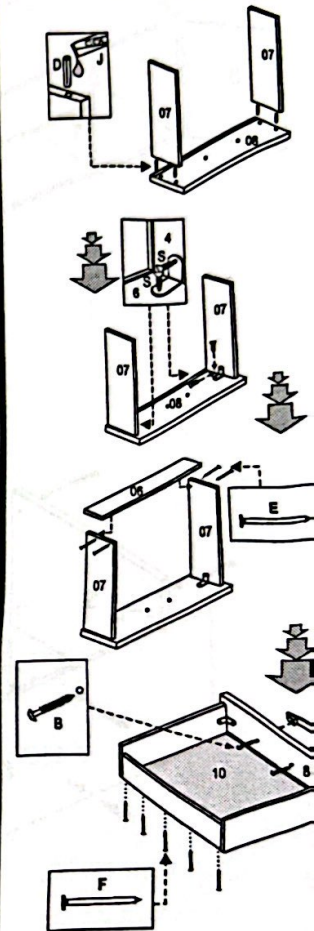







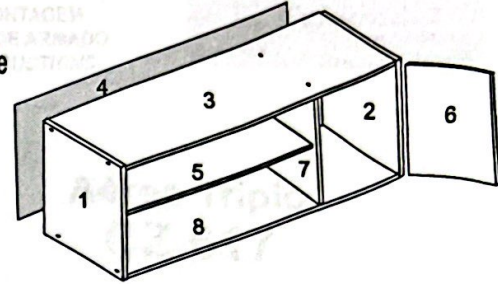

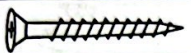

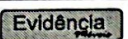

FERRAGENS/ HERRAJE/ HARDWARE

Peças do Produto

- 1 - Lateral Esquerda / Lateral izquierda / Left Side
 2 - Lateral direita / Lateral derecha / Right side
 3 - Tampo superior / Tapa superior / Upper top
 4 - Costa / Espalda / Back
 5 - Prateleira / Estante / Shelf
 6 - Porta / Puerta / Door (3x)
 7 - Divisão / División / Divider
 8 - Tampo inferior / Tapa inferior / Lower top

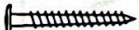

A	Parafuso 4,0 x 40 c/chata Tornillo Screw		12
B	Parafuso 3,5 x 25 c/flangeada Tornillo Screw		6
C	Prego 10 x 10 Clavo 10 x 10 Nail 10 x 10		40
D	Etiqueta Logomarca Label		1
E	Puxador 128 mm Tirador Handle		3
F	Parafuso 3,5 x 12 c/Chata Tornillo Screw		30
G	Pino Suporte Prateleira 8x5,5		8
H	Porca cilíndrica Tuerca cilíndrica Cylindrical nut		8
J	Dobradilha 26 c/calço		6
M	Suporte aéreo Soporte Support		2
N	Bucha 8 mm Bucha Bucha		2
N	Proteção Cantoneira Proteção Cantoneira Proteção Cantoneira		2
P	Parafuso 5,0x50 Tornillo Screw		2
Q	Cavilha 6x 30 Clavija Wood Peg		4

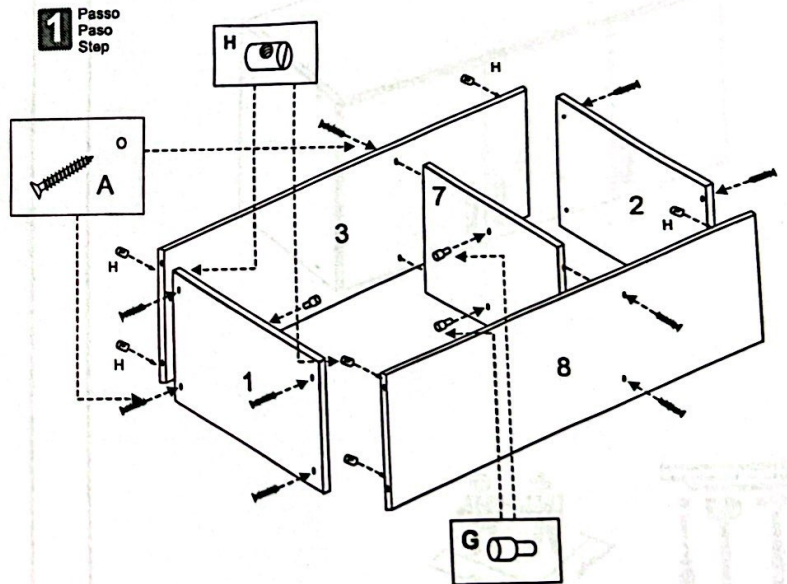

2 Paso
Step

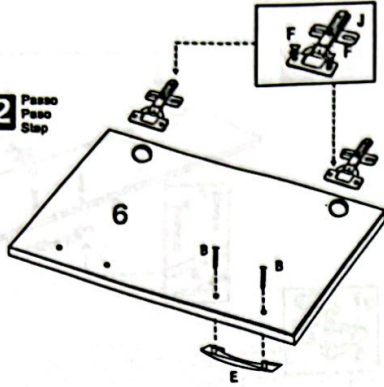

3 Paso
Step

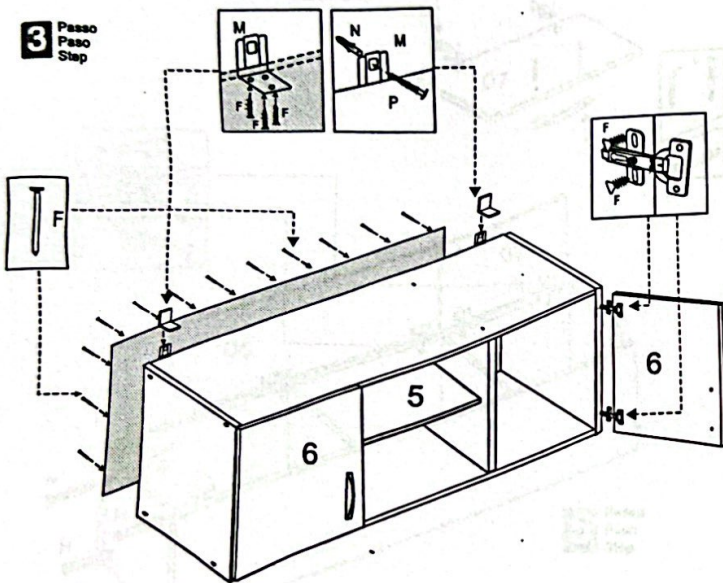

MANUAL DE MONTAGEM
INSTRUCCIONES DE ARMADO
ASSEMBLY INSTRUCTIONS

Evidência
Móveis



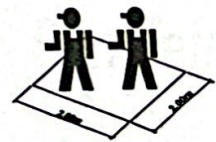
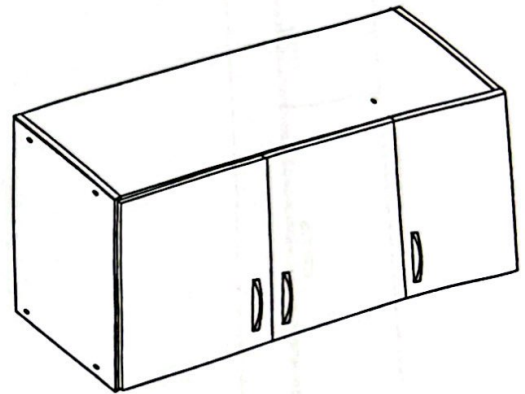





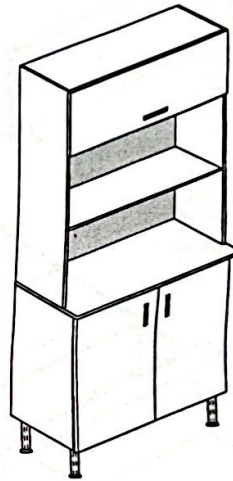



**Aéreo Triplo
CZ 617**



FERRAMENTAS /
HERRAMIENTAS /
TOOLS NEC.



MANUAL DE MONTAGEM
INSTRUCCIONES DE ARMADO
ASSEMBLY INSTRUCTIONS

Torre Quente
FERRAGENS/ HERRAJE/ HARDWARE

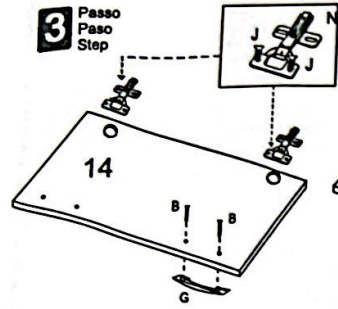
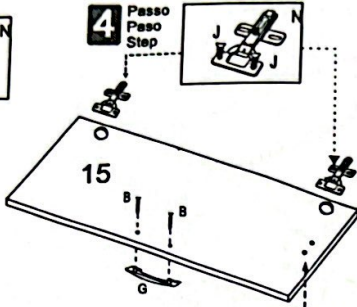
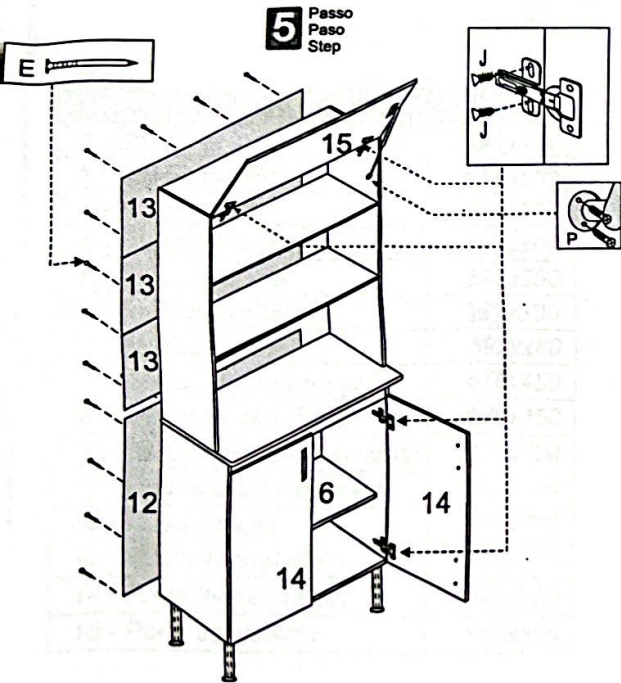
A	Parafuso 3,5 x 35 c/chato		22
B	Parafuso 3,5 x 25 c/flangeada		6
C	Cantoneira 18x18		2
D	Cavilha 6 x 30		8
E	Prego 10 x 10		40
F	Cola	COLA	1
G	Puxador 128 mm		3
H	Parafuso 4,5 x 35		4
J	Parafuso 3,5 x 12 c/Chato		28
L	Sapata para cozinha		4
M	Porca cilíndrica		12
N	Dobradiça 26 c/calço		6
P	Pistão		1
Q	Suporte Prateleira		1

3 Passo
 Paso
 Step

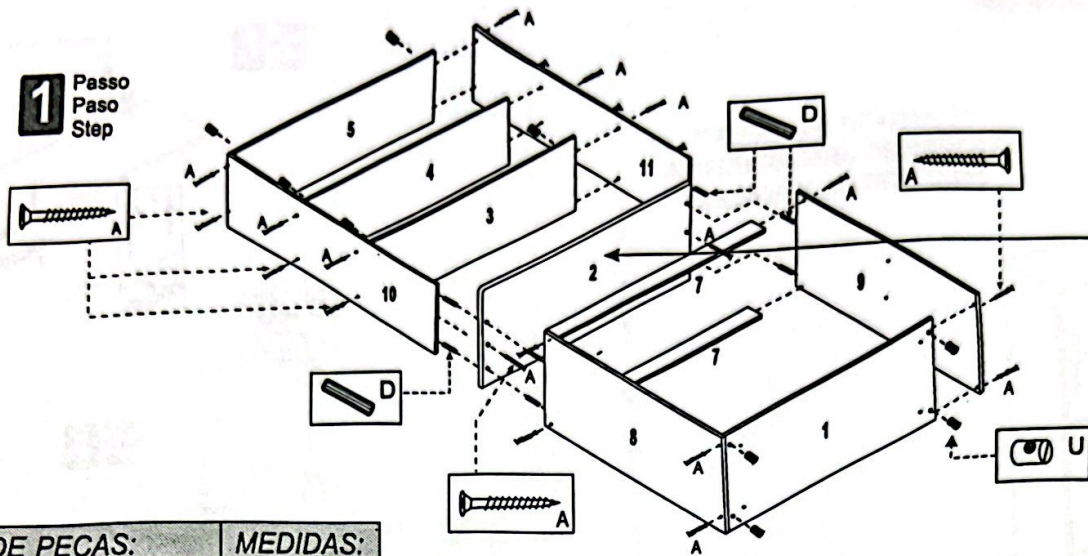
4 Passo
 Paso
 Step

5 Passo
 Paso
 Step

1 Passo
Paso
Step

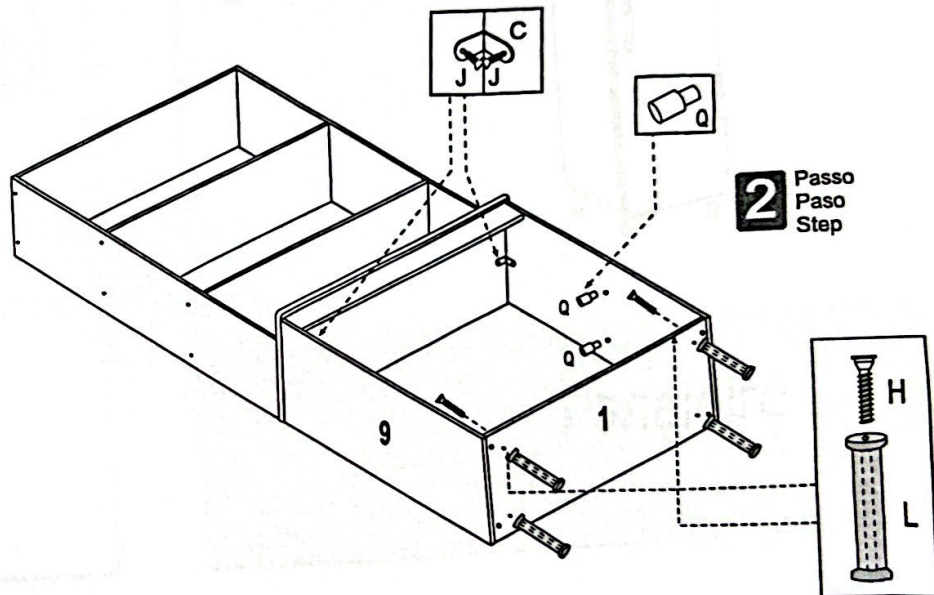

Obs.:
* Montar primeiro a parte superior da torre com o tampo (pç.2), com o parafuso (A) 3,5x35

RELAÇÃO DE PEÇAS:	MEDIDAS:
1 - Base	592x450
2 - Tampo balcão	635x465
3 - Tampo central	385x592
4 - Prateleira superior	592x300
5 - Tampo superior	592x300
6 - Prateleira inferior	592x300
7 - Travessas (2 pç)	592x60
8 - Lateral balcão esquerda	670x450
9 - Lateral balcão direita	670x450
10 - Lateral esquerda superior	1130x300
11 - Lateral direita superior	1130x300
12 - Costa balcão	680x610
13 - Costa central (3pç)	603x300
14 - Porta Inferior (2 pç)	620x300
15 - Porta basculante	610x300



2 Passo
Paso
Step