



***ROUPEIRO SEVILHA 2 GAVETAS***  
***Código: 9266***

***Benetil***  
Móveis

Av. Jesus Candian, 395 - B. Mangueira Rural  
**Telefax (32) 3539-5350**  
CEP 36500-000 - Ubá - Minas Gerais  
[www.benetil.com.br](http://www.benetil.com.br)



# RELAÇÃO DE FERRAGENS EM TAMANHO REAL (MEDIDA EM MILÍMETRO).



A - PARAF. 3,5x14

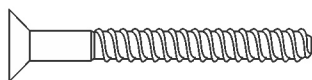

B - PARAF. 5x40

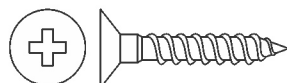

C - PARAF. 4,0x25

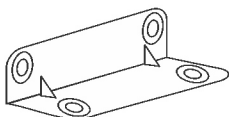

D - CANTONEIRA 4 FUROS

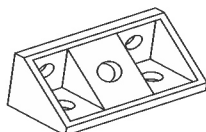

E - CANTONEIRA 4 FUROS

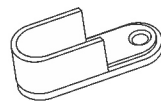

F - SUPORTE CABIDEIRO

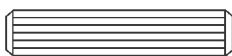

G - CAVILHA 6x30



H - PREGO 10x10

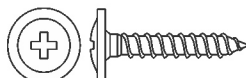

I - PARAF. 3,5x20 FLANGEADO

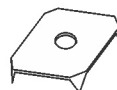

J - FIXADOR DE COSTAS

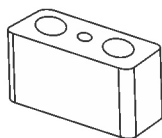

K - ALONGADOR DE CORREDIÇA



M - PUXADOR

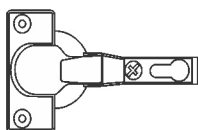

N - DOBRADIÇA



O - CALÇO



P - CABIDEIRO

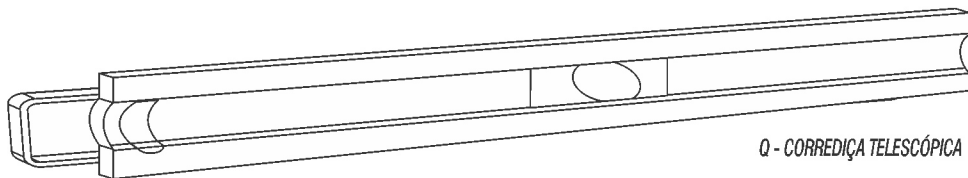

Q - CORREDIÇA TELESCÓPICA



# FAVOR IDENTIFICAR AS PEÇAS E COLOCAR SEUS RESPECTIVOS ACESSÓRIOS

## Sequência de Montagem

- 01 - Parafusar peças 2 nas peça 3;
- 02 - Parafusar peça 1 nas 2;
- 03 - Parafusar peça 4 nas peças 2;
- 04 - Parafusar os Pés 19 nos rodapés 2.

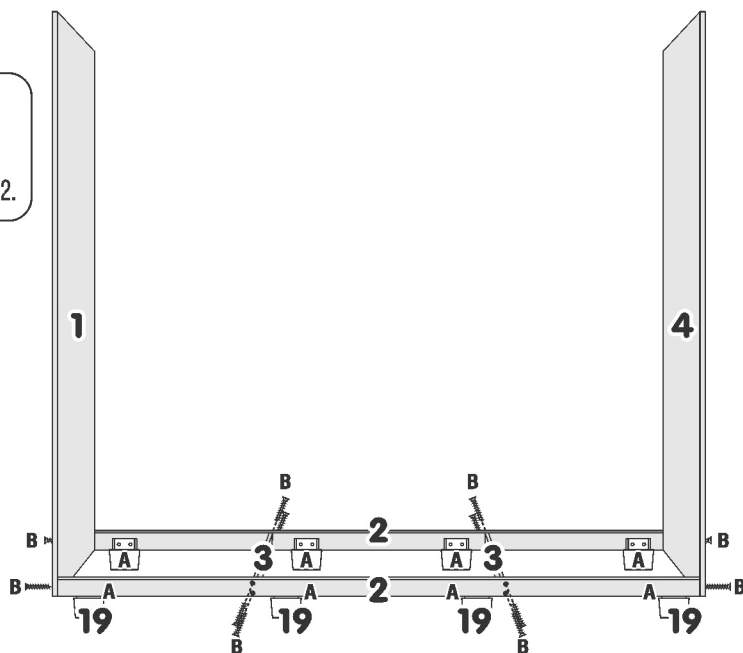
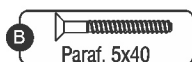
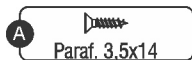

## Sequência de Montagem

- 05- Parafusar peça 5 nas peças 2;
- 06- Encaixar as peça 6 e 7 na peça 5 conforme desenho.

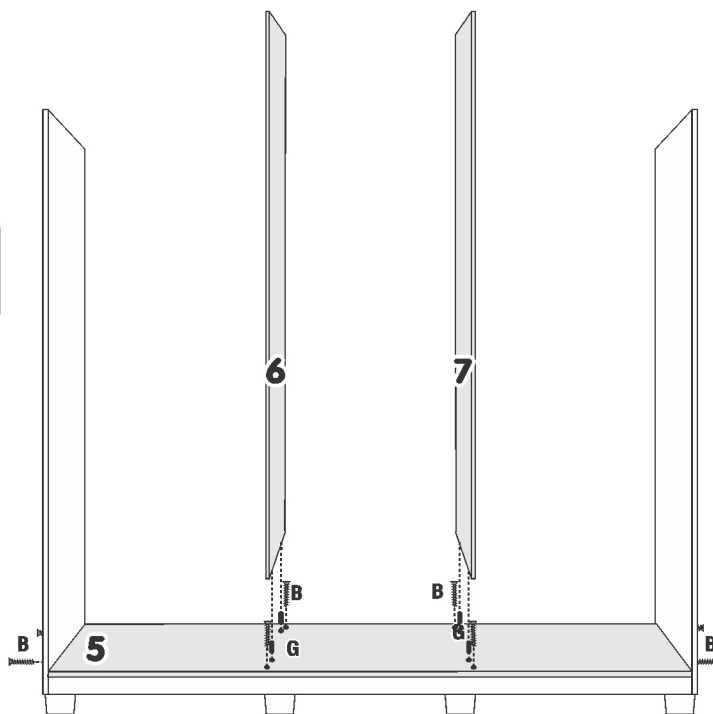
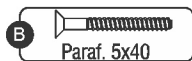

## Sequência de Montagem

07 - Parafusar peça 8 conforme desenho.

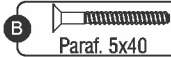

**ATENÇÃO:**  
A PRATELEIRA 8 CENTRAL PODE  
SER MONTADA NO LADO DIREITO  
PASSANDO O CABIDEIRO PARA  
A PARTE CENTRAL, FAVOR  
DEFINIR A POSIÇÃO DOS  
MESMOS NESTE PASSO.

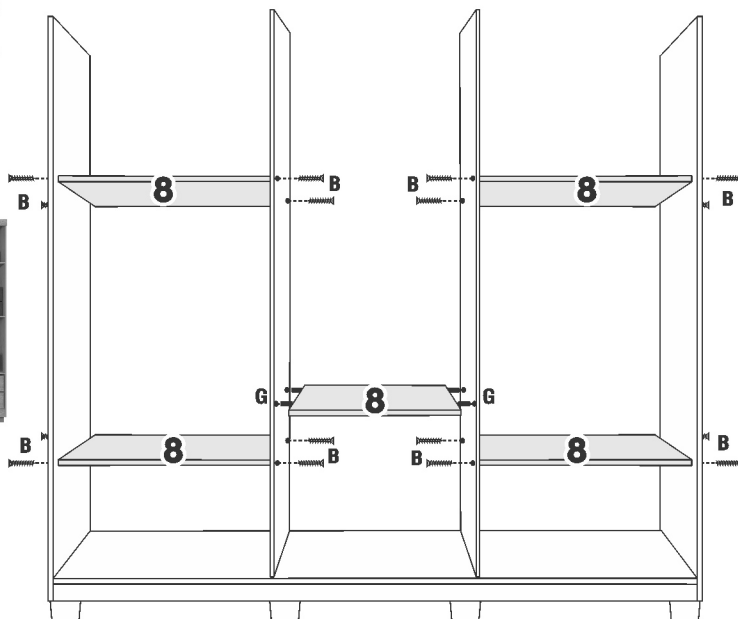

## Sequência de Montagem

08- Parafusar peça 9 e encaixar as peças 10 e 11 conforme desenho.

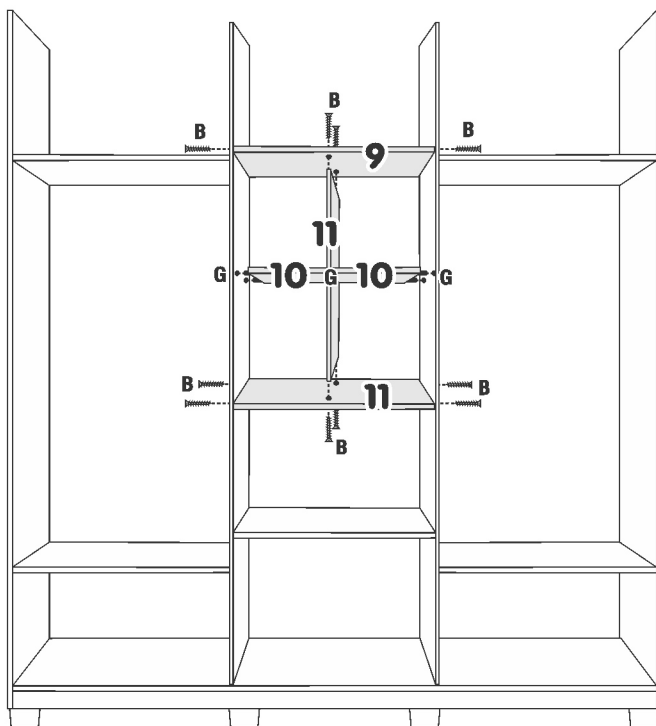

## Sequência de Montagem

- 09 - Parafusar a peça 20 nas peças 1, 4, 6, e 7.  
10 - Parafusar a Alongador de corredeira nas peças 1, 4, 6, e 7 conforme desenho.

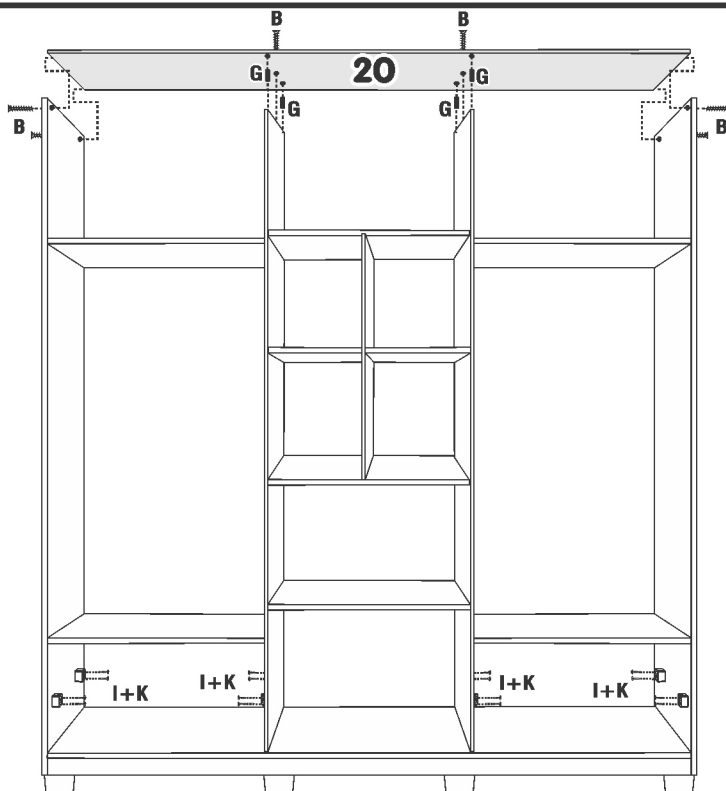
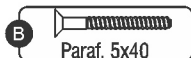

## Sequência de Montagem

- 11 - Parafusar a peça 12 nas peças 1, 4, 5 e 20;  
12 - Parafusar as corredeiras nos alongadores, **ATENÇÃO: CADA CORREDEIRA TEM SEU RESPECTIVO PAR;**  
13 - Parafusar suporte de cabideiro conforme desenho ao lado.

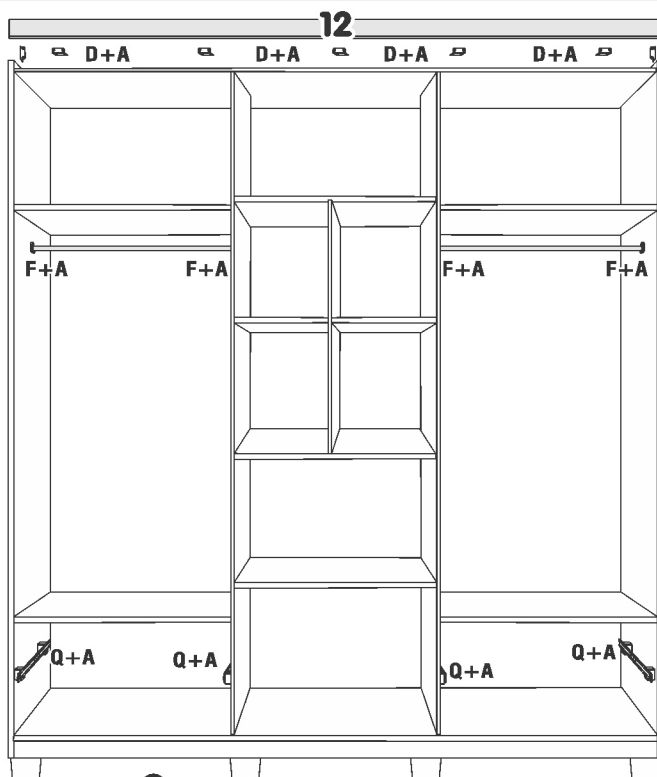

## Seqüência de Montagem

14 - Preguar as Costas 14 conforme desenho ao alado.

OBS.: Acertar as costas para melhor esquadrejamento do móvel.

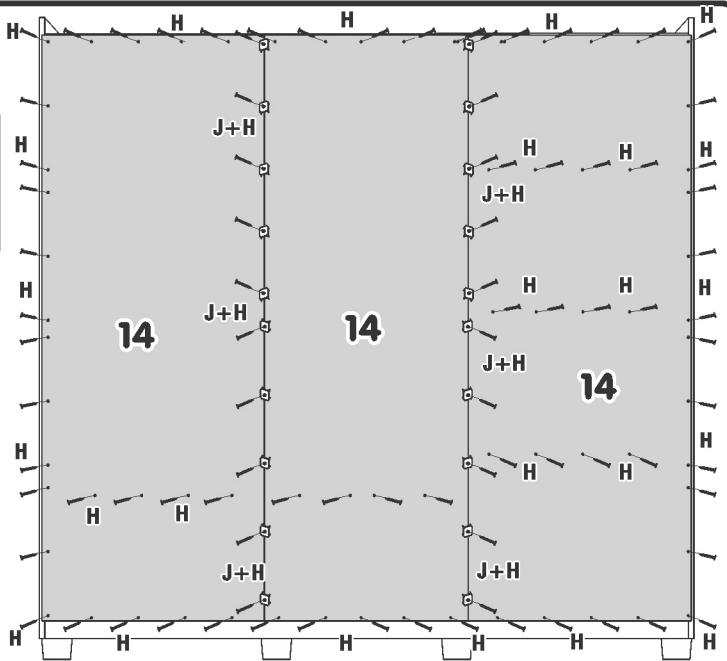

## Seqüência de Montagem

15 - Montar e fixar as Portas 13.

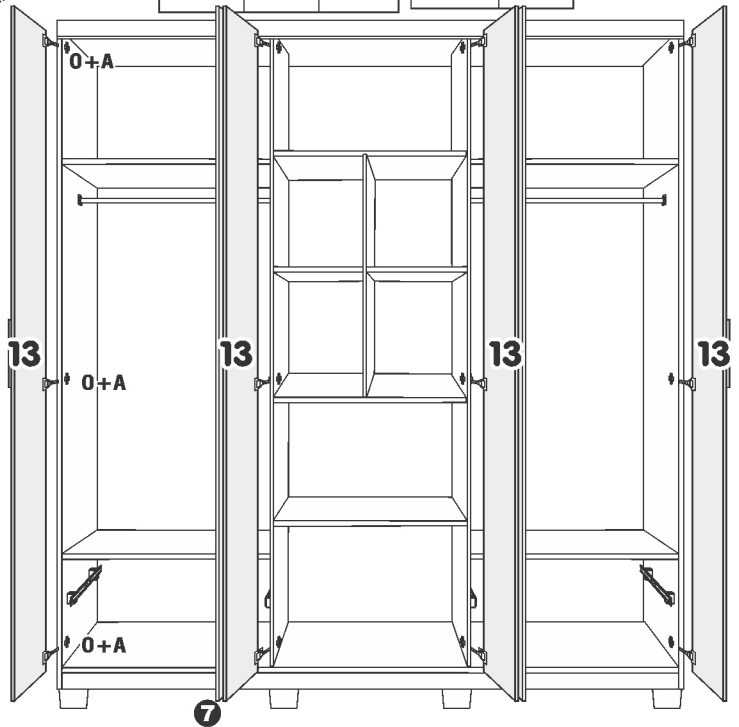
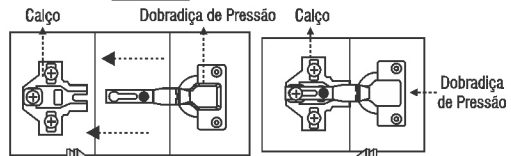
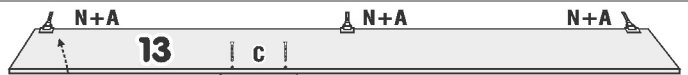
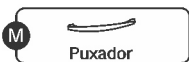
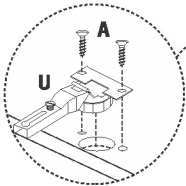

## Sequência de Montagem

- 16 - Parafusar as cantoneiras nas peças 16;
- 17 - Parafusar as peças 16 nas peças 15;
- 18 - Parafusar a peça 17 nas peças 16;
- 19 - Parafusar peça 18 nas peças 16 e 17 conforme desenho abaixo, ajustando para melhor esquadramento da Gaveta;
- 20 - Parafusar as corredeiras nas laterais da peça 16.

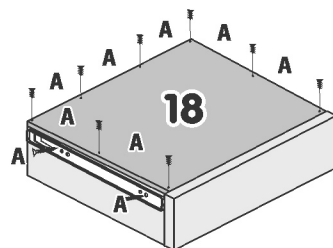
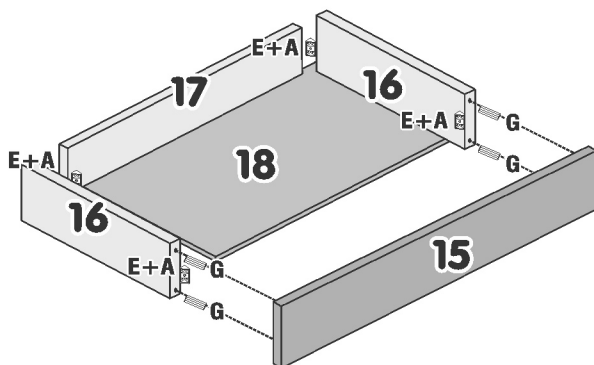

# Benetil

Móveis

Av. Jesus Candian, 395 - B. Mangueira Rural

Telefax (32) 3539-5350

CEP 36500-000 - Ubá - Minas Gerais

[www.benetil.com.br](http://www.benetil.com.br)

# ESQUEMA MONTAGEM SUPORTE FUNDO DE GAVETA

