

MEDIDA DO PRODUTO MONTADO

MEASURE OF THE ASSEMBLED PRODUCT
MEDIDA DEL PRODUCTO ENSAMBLADO

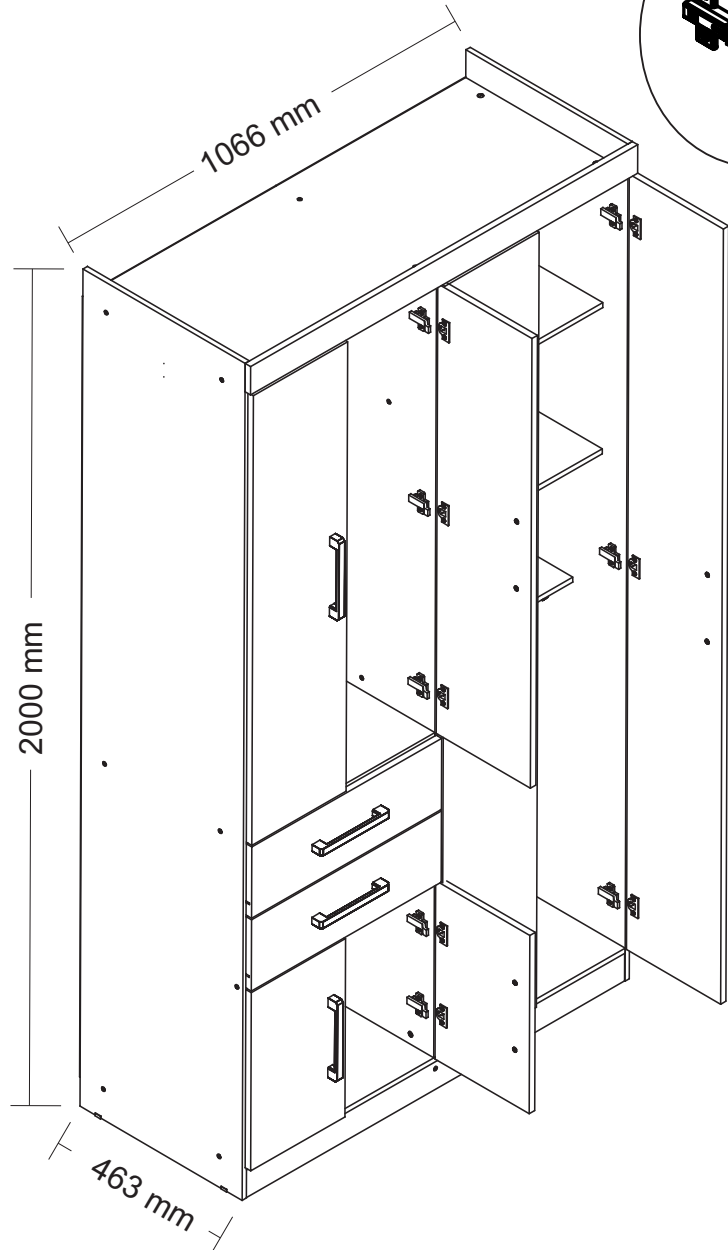

+55 (43)3538-8300

GR. VERONA 6.2

WARDROBE VERONA 6.2
ROPERO VERONA 6.2

ESQUEMA DE MONTAGEM 949301-02

ASSEMBLING INSTRUCTIONS
MANUAL DE ARMADO

santos
Andirá

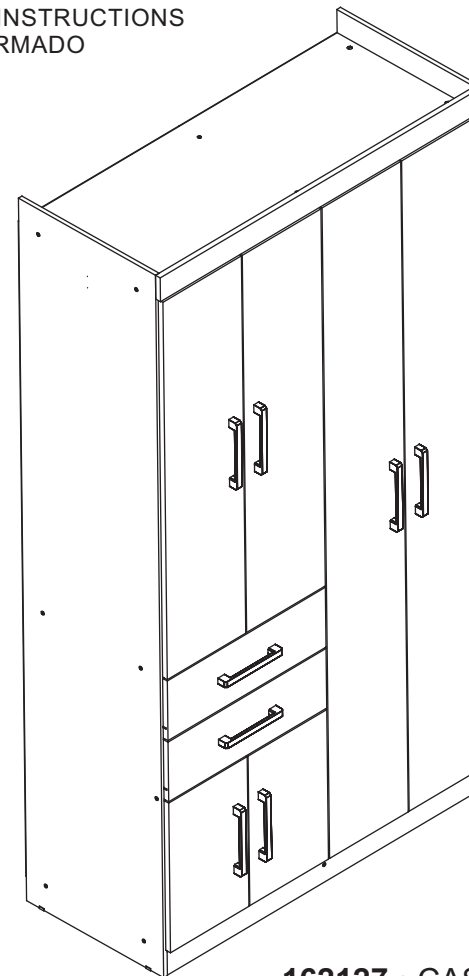

120 minutos
120 minutes

- 162127 • CASTANHA/OFF WHITE
- 162158 • ATACAMA/GRAFITE
- 162143 • JATOBÁ/AREIA
- 162144 • JATOBÁ/JATOBÁ
- 162166 • BRANCO/BRANCO
- 162199 • EBANO/EBANO

www.santosandira.com.br

AVISO

Para limpeza do seu móvel utilize flanela seca ou levemente umedecida, sem produtos químicos!

WARNING

To clean your mobile use dry cloth or slightly moistened, no chemicals!

ADVERTENCIA

Para limpiar su mueble use un paño seco o ligeramente humedecido, sin productos químicos!



ISO 14001



ISO 9001



Descarte os resíduos de forma seletiva!

Dispose of waste selectively!

¡Deseche los residuos de manera selectiva!

Em caso de produto com espelho siga as instruções abaixo:

In the case of a product with a mirror, follow the instructions below

En el caso de un producto con espejo, siga las instrucciones a continuación:

Cole os espelhos na porta e aguarde cerca de 01 hora para fazer a colocação da mesma no produto.

Attach the mirrors to the door and wait about 01 hour to place it on the product.

Coloque los espejos en la puerta y espere alrededor 01 hora para colocarlos sobre el producto.

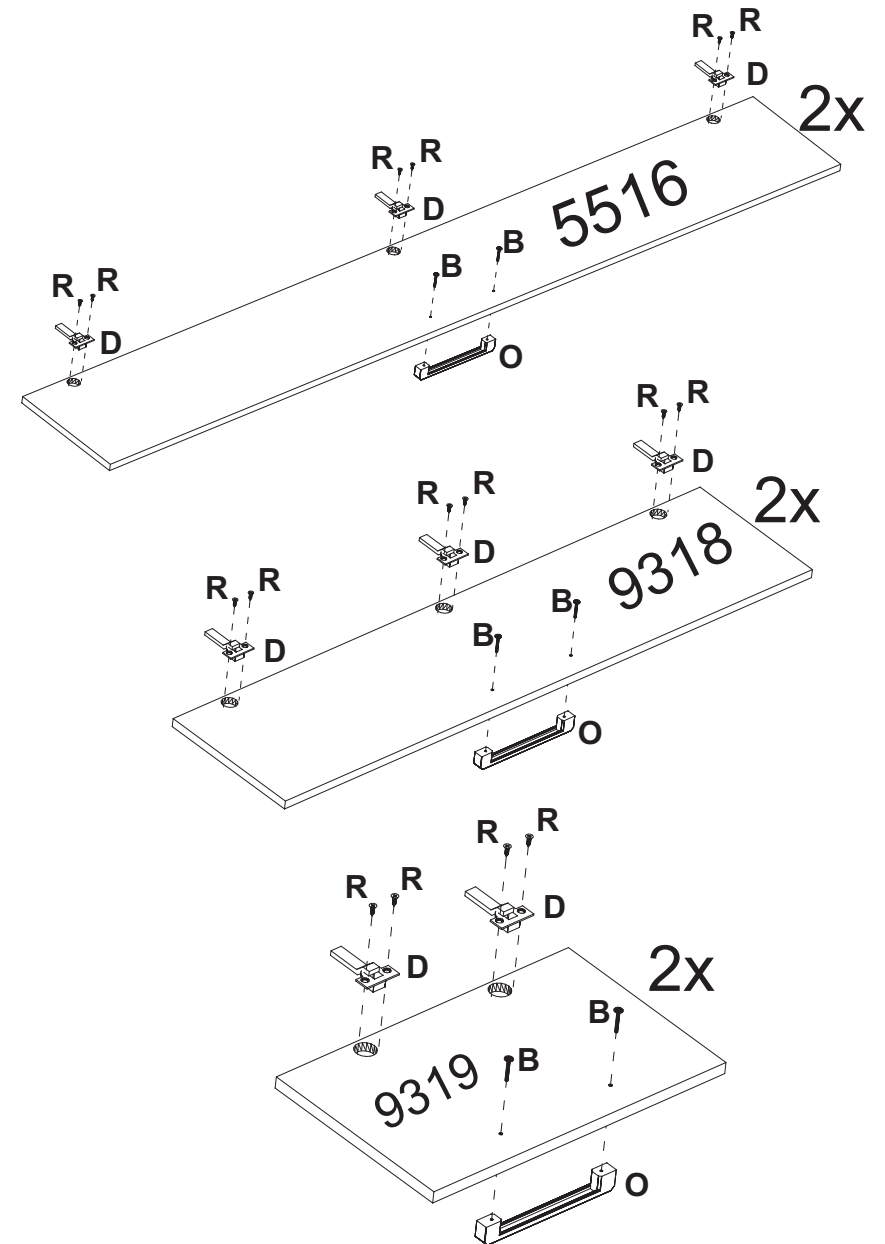

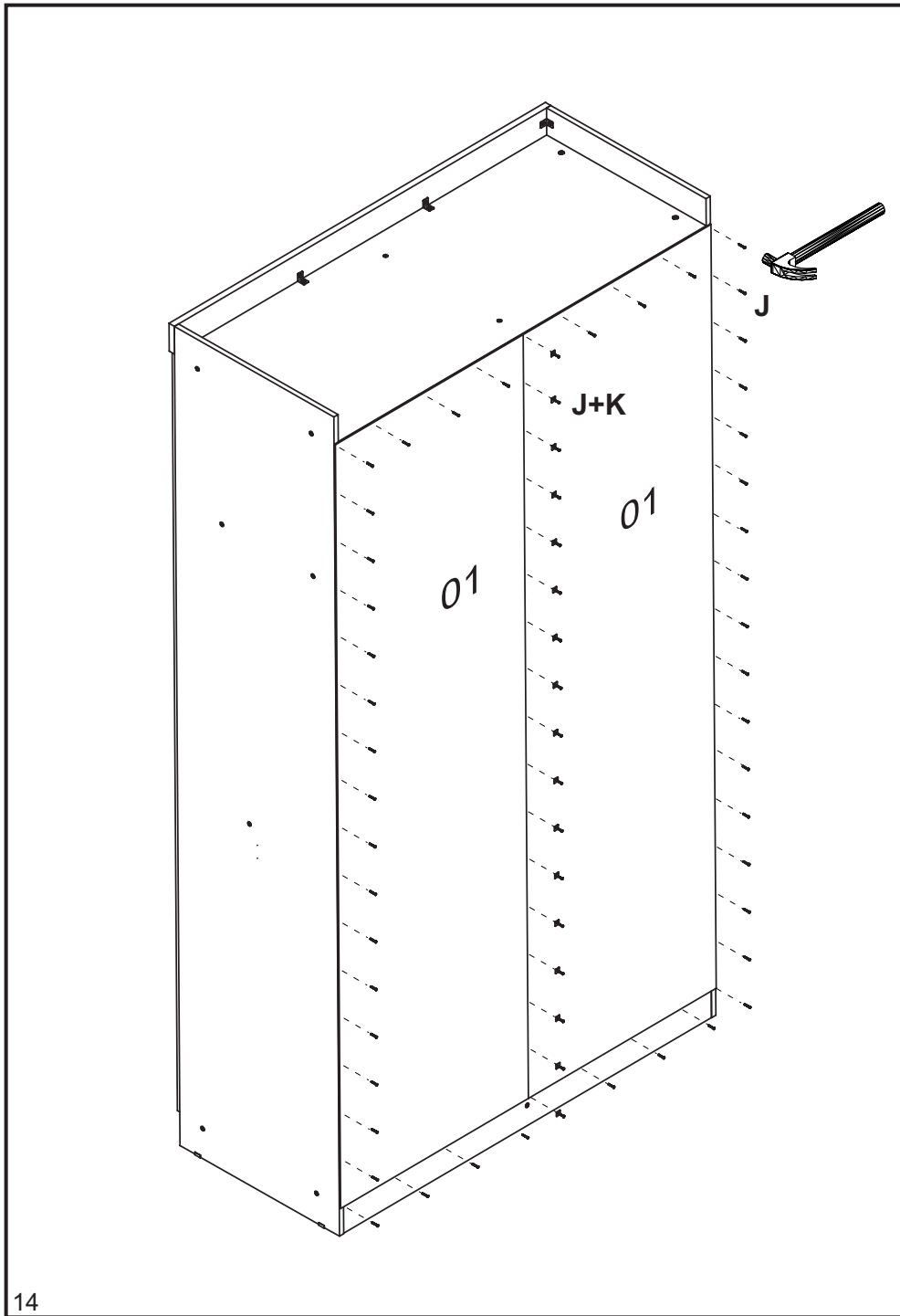







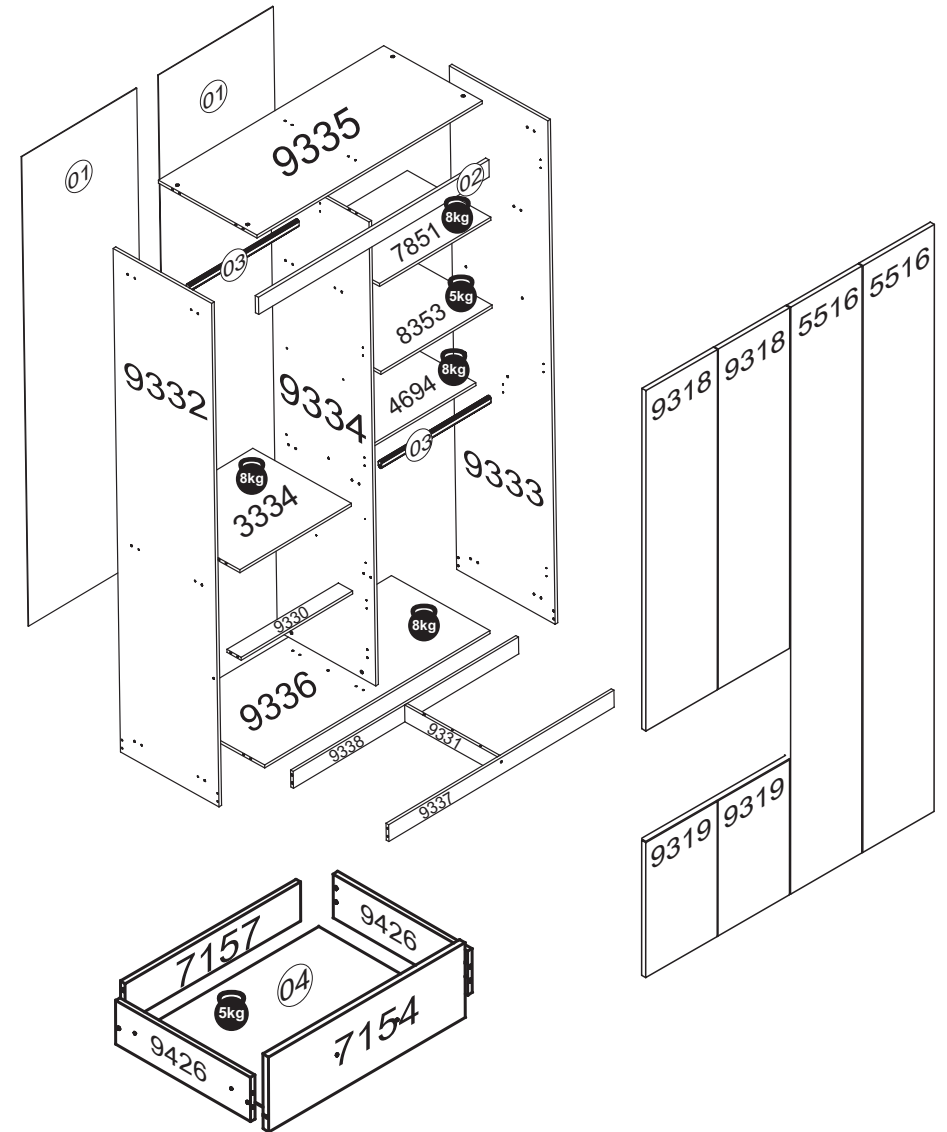







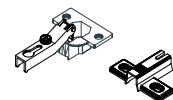



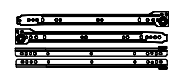

O peso máximo da carga exibido no desenho refere-se a objetos distribuídos de maneira uniforme sobre toda a área de contato da peça.

The maximum loading weight the image shows refers to objects distributed uniformly over the whole part contact area.

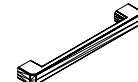
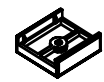
El peso máximo de carga informado en el diseño se refiere a objetos distribuidos uniformemente sobre totalidad de la área de contacto de la pieza.

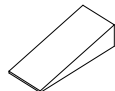

RELAÇÃO DE ACESSÓRIOS
LIST OF ACCESSORIES • LISTA DE ACCESORIOS

<p>A 22</p>  <p>PARAFUSO FI CH PH 4,0x50 SCREW FI CH PH 4,0x50 TORNILLO FI CH PH 4,0x50</p>	<p>B 16</p>  <p>PARAFUSO FI FL PH 3,5x30 SCREW FI FL PH 3,5x30 TORNILLO FI FL PH 3,5x30</p>	<p>C 02</p>  <p>PORCA SX MA4 NUT SX MA4 TUERCA SX MA4</p>	<p>D 16</p>  <p>DOBRA METAL 26mm C/ CALÇO METAL HINGE 26mm WITH EDGE BISAGRA METAL 26mm CON CALZO</p>
<p>E 68</p>  <p>PARAFUSO FI CH PH 4,0x12 SCREW FI CH PH 4,0x12 TORNILLO FI CH PH 4,0x12</p>	<p>F 50</p>  <p>CAVILHA MADEIRA 6x25 WOOD PEG 6x25 TARUGO DE MADEIRA 6x25</p>	<p>G 22</p>  <p>PORCA CILINDRICA 12x09 CYLINDRICAL NUT 12x09 TUERCA CILINDRICA 12x09</p>	<p>H 08</p>  <p>CANTONEIRA METAL BRACKET METAL CANTONEIRA METAL</p>
<p>I 02</p>  <p>CONJ. CORREDIÇA METAL 350mm SET OF METAL SLIDES 350mm CONJ. DE RIELES DE METAL 350mm</p>	<p>J 90</p>  <p>PREGO 10x10 NAIL 10x10 CLAVO 10x10</p>	<p>K 16</p>  <p>FIXADOR FUNDO BACKBOARD'S FIXER FIJADOR DEL COSTADO</p>	<p>L 04</p>  <p>SUPORTE CABIDEIRO OB. HANGER HOLDER SOPORTE PARA PERCHERO</p>
<p>M 07</p>  <p>PARAFUSO FI CH PH 3,5x40 SCREW FI CH PH 3,5x40 TORNILLO FI CH PH 3,5x40</p>	<p>N 02</p>  <p>PINO GIROFIX 35mm GIROFIX PIN 35mm TORNILLO DEL GIROFIX 35mm</p>	<p>O 08</p>  <p>PUX. VERO 160mm HANDLE VERO 160mm TIRADOR VERO 160mm</p>	<p>P 06</p>  <p>SAPATA LAT. MINI 12mm SHOE SIDE. MINI 12 mm SAPATA LAT. MINI 12mm</p>
<p>Q 01</p>  <p>COLA PVA GLUE PVA COLA PVA</p>	<p>R 32</p>  <p>PARAFUSO FI CH PH 4,0x14 SCREW FI CH PH 4,0x14 TORNILLO FI CH PH 4,0x14</p>	<p>S 06</p>  <p>PREGO 12x12 NAIL 12x12 CLAVO 12x12</p>	<p>T 02</p>  <p>PARAFUSO MQ PN PH 4,0x25 SCREW MQ PN PH 4,0x25 TORNILLO MQ PN PH 4,0x25</p>
<p>U 02</p>  <p>CASTANHA GIROFIX 12x09 MINIFIX 12x09 MINIFIX 12x09</p>	<p>V 04</p>  <p>CUNHA WEDGE CUÑA</p>		

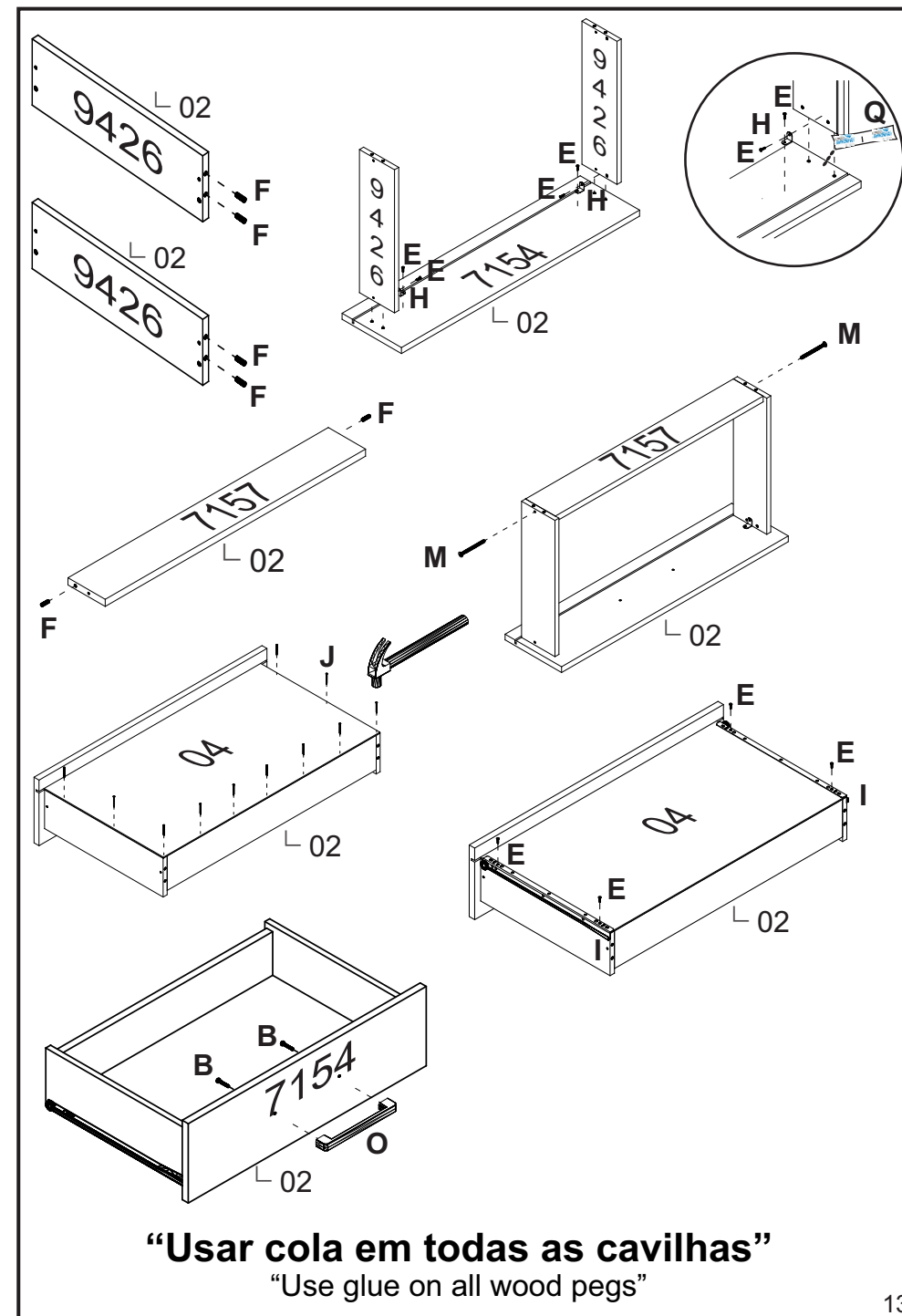

RELAÇÃO DE PEÇAS
LIST OF PARTS • LISTA DE PARTES

DESCRIÇÃO DESCRIPTION DESCRIPCIÓN	VOLUME VOLUME VOLUMEM	NÚMERO NUMBER NUMERO	DIMENSÃO DIMENSION DIMENSIÓN	QUANTIDADE QUANTITY CANTIDAD
PORTA DOOR PUERTA	02	5516	1852x260x15	02
FRENTE DE GAVETA DRAWER'S FRONT FRENTE DEL CAJÓN	02	7154	523x170x15	02
PORTA DOOR PUERTA	02	9318	1074x260x15	02
PORTA DOOR PUERTA	02	9319	426x260x15	02

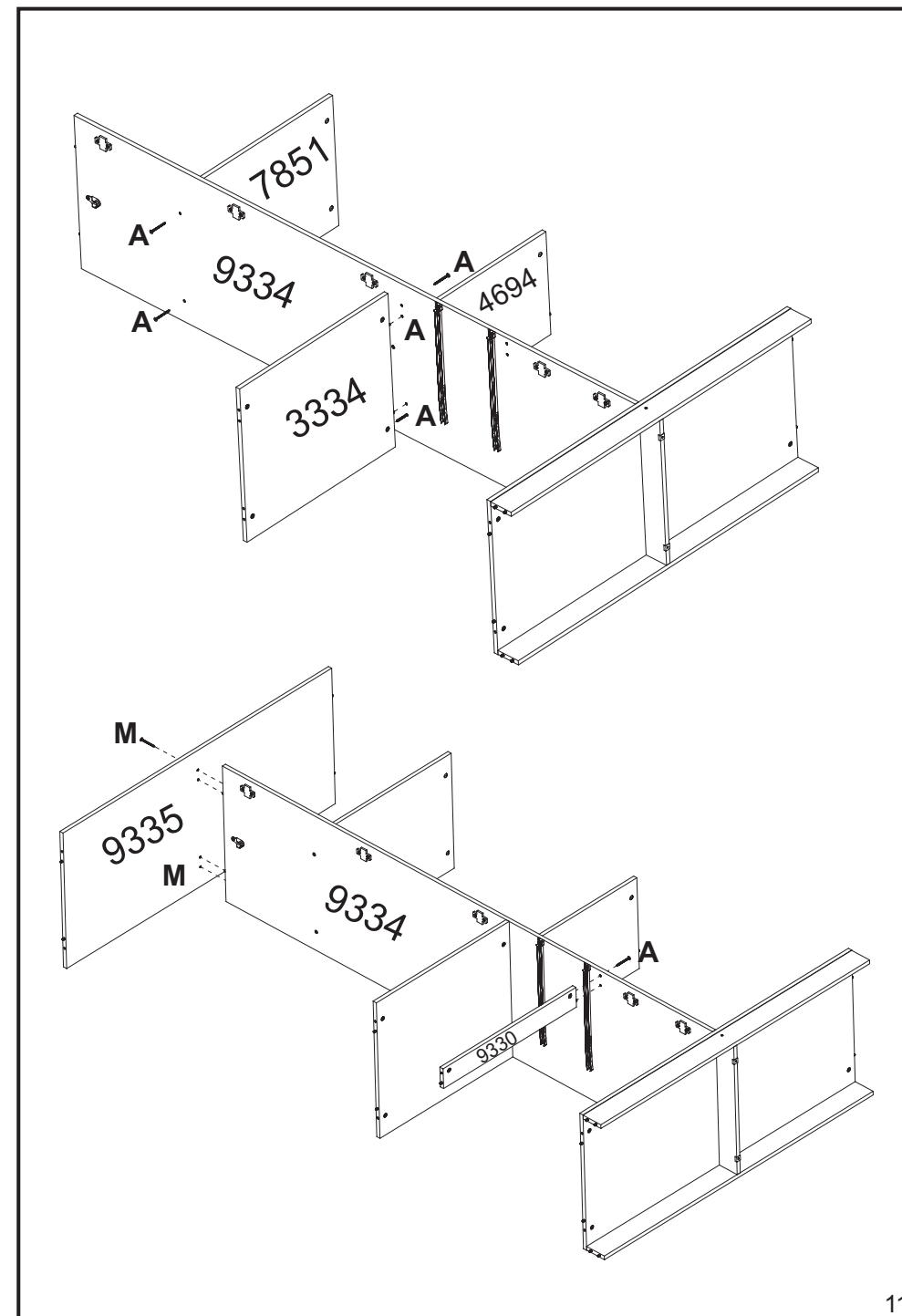

Ps: Peças e Complementos que não contém processo de furação não são enumeradas.
Parts and Accessories that do not contain drilling process and are not listed.
Piezas y Accesorios que no contienen procesos de perforación y que no numerados.

