

GR. MASTER NEW 8.4

WARDROBE MASTER NEW 8.4
ROPERO MASTER NEW 8.4

ESQUEMA DE MONTAGEM 946025

ASSEMBLING INSTRUCTIONS
MANUAL DE ARMADO

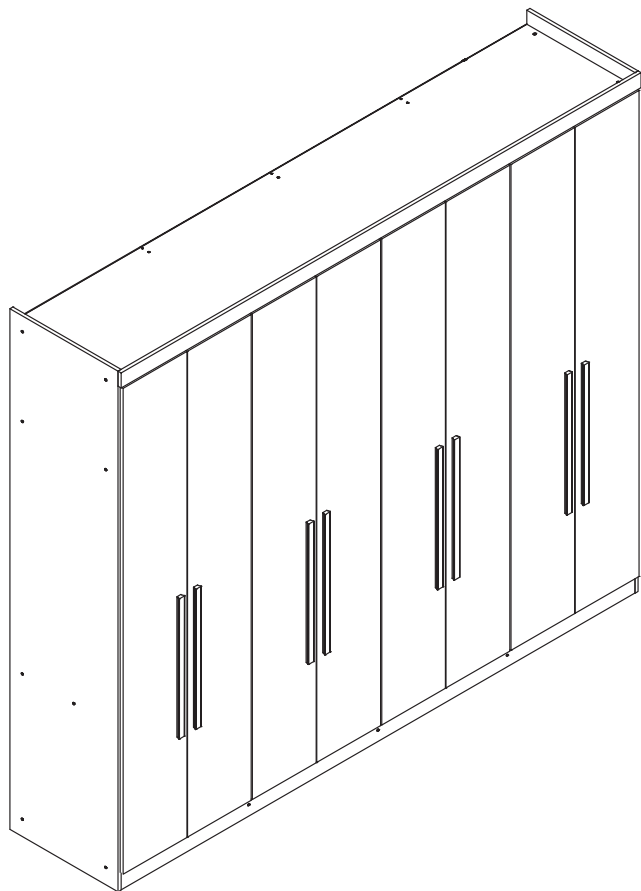

120 minutos
120 minutes

163243 • JATOBA/AREIA
163244 • JATOBÁ/JATOBÁ
163248 • JATOBÁ/GRAFITTE
163266 • BRANCO/BRANCO

www.santosandira.com.br

01

santos
Andirá



ESCANEIE O QR CODE
OU CLIQUE AQUI PARA
RESPONDER A PESQUISA



AVISO

Para limpeza do seu móvel utilize flanela seca ou levemente umedecida, sem produtos químicos!

WARNING

To clean your mobile use dry cloth or slightly moistened, no chemicals!

ADVERTENCIA

Para limpiar su mueble use un paño seco o ligeramente humedecido, sin productos químicos!



ISO 14001



ISO 9001



Descarte os resíduos de forma seletiva!

Dispose of waste selectively!

¡Deseche los residuos de manera selectiva!

Em caso de produto com espelho siga as instruções abaixo:

In the case of a product with a mirror, follow the instructions below

En el caso de un producto con espejo, siga las instrucciones a continuación:

Cole os espelhos na porta e aguarde cerca de 01 hora para fazer a colocação da mesma no produto.

Attach the mirrors to the door and wait about 01 hour to place it on the product.

Coloque los espejos en la puerta y espere alrededor 01 hora para colocarlos sobre el producto.

02

O peso máximo da carga exibido no desenho refere-se a objetos distribuídos de maneira uniforme sobre toda a área de contato da peça.





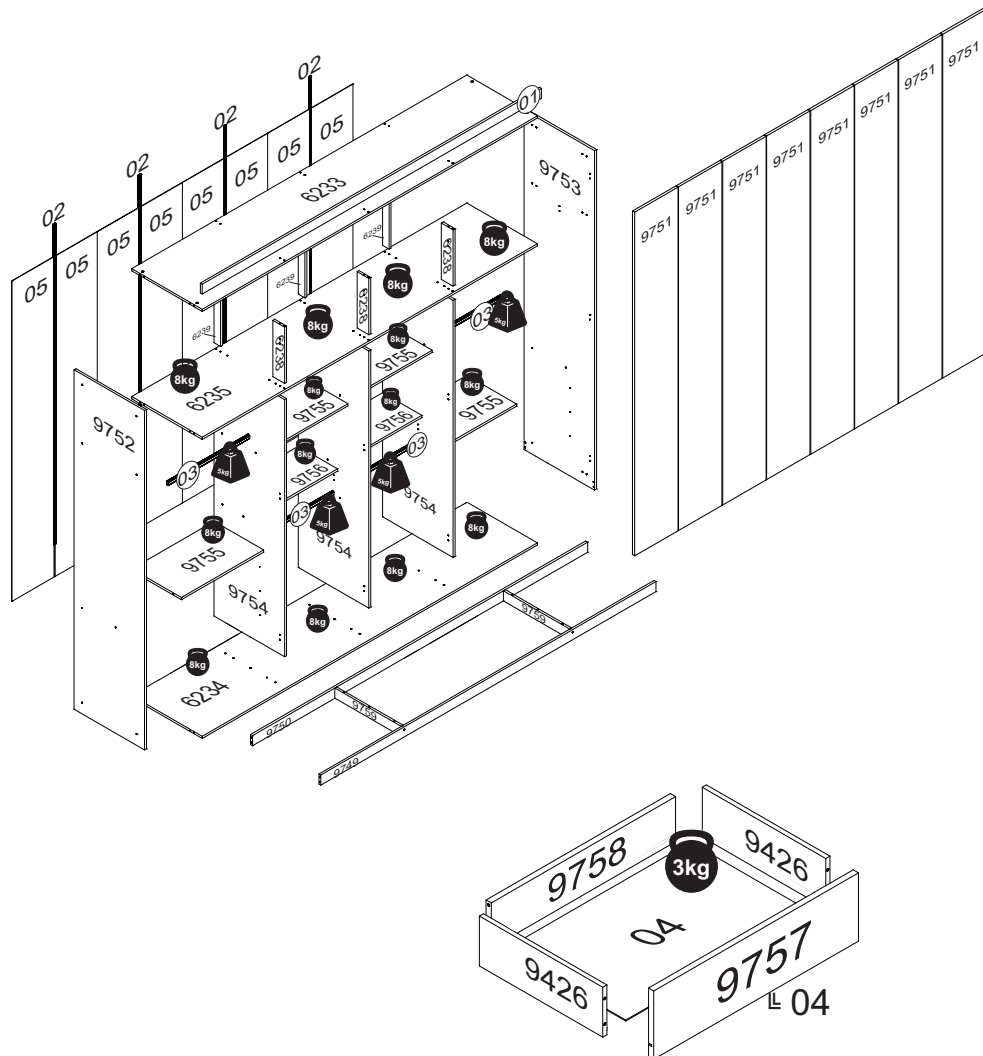





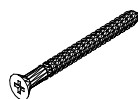







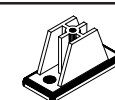
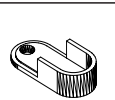

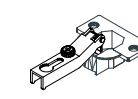
The maximum loading weight the image shows refers to objects distributed uniformly over the whole part contact area.

El peso máximo de carga informado en el diseño se refiere a objetos distribuidos uniformemente sobre totalidad de la área de contacto de la pieza.

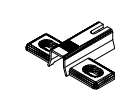

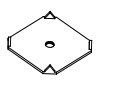
TOTAL DE PESO SUPORTADO: 144 kg
TOTAL WEIGHT SUPPORTED: 144 kg
PESO TOTAL SOPORTADO: 144 kg

RELAÇÃO DE ACESSÓRIOS LIST OF ACCESSORIES • LISTA DE ACCESORIOS

A 42 	B 26 	C 118 	D 13 
PARAFUSO FI CH PH 4,0x50 SCREW FI CH PH 4,5x45 TORNILLO FI CH PH 4,5x45	PARAFUSO FI CH PH 3,5x40 SCREW FI CH PH 3,5x40 TORNILLO FI CH PH 3,5x40	PARAFUSO FI CH PH 4,0x12 SCREW FI CH PH 4,0x12 TORNILLO FI CH PH 4,0x12	CANTONEIRA METAL BRACKET METAL CANTONEIRA METAL
E 04 	F 73 	G 40 	H 04 
CUNHA WEDGE CUÑA	CAVILHA MADEIRA 6x25 WOOD PEG 6x25 TARUGO DE MADEIRA 6x25	PORCA CILINDRICA 12x09 CYLINDRICAL NUT 12x09 TUERCA CILINDRICA 12x09	CORREDIÇA TELESCÓPICA TELESCOPIC SLIDES RIELES TELESCÓPICO
I 16 	J 08 	K 24 	L 174 
DISTANCIADOR SPACER ESPACIADOR	SUPORTE CABIDEIRO OB. HANGER HOLDER SOPORTE PARA PERCHERO	PARAFUSO FI FL PH 3,5x25 SCREW FI FL PH 3,5x25 TORNILLO FI FL PH 3,5x25	PREGO 10x10 NAIL 10x10 CLAVO 10x10
M 24 	N 01 	O 18 	P 18 
DOBRA METAL 26mm METAL HINGE 26mm BISAGRA METAL 26mm	COLA PVA GLUE PVA COLA PVA	PARAFUSO MQ PN PH 4x25 SCREW MQ PN PH 4x25 TORNILLO MQ PN PH 4x25	PORCA SX MA 4 NUT SX MA 4 TUERCA SX MA 4
Q 24 	R 08 	S 54 	T 08 
CALÇO P/ DOBRA 5mm WEDGE FOR HINGE 5mm CALZO P/ BISAGRA 5mm	SAPATA LAT. MINI 12mm SHOE SIDE. MINI 12mm SAPATA LAT. MINI 12mm	FIXADOR FUNDO BACKBOARD'S FIXER FIJADOR DEL COSTADO	PREGO 12x12 NAIL 12x12 CLAVO 12x12
U 48 	V 08 		
PARAFUSO FI CH PH 4,0x14 SCREW FI CH PH 4,0x14 TORNILLO FI CH PH 4,0x14	PUX. MDF 606mm HANDLE MDF 606mm TIRADOR MDF 606mm		

RELAÇÃO DE PEÇAS
LIST OF PARTS • LISTA DE PARTES

DESCRIÇÃO DESCRIPTION DESCRIPCIÓN	VOLUME VOLUME VOLUMEM	NÚMERO NUMBER NÚMERO	DIMENSÃO DIMENSION DIMENSIÓN	QUANTIDADE QUANTITY CANTIDAD
VISTA SUP. SUPERIOR FRONTAGE VISTA SUPERIOR	01	01	2388x073x15	01
PERFIL H H PROFILE PERFIL	01	02	2035mm	04
CABIDEIRO ECO. FRIZADO FRIZZED ECO HANGER PERCHERO ECO. FRIZADO	01	03	573mm	04
CHAPÉU WARDROBE'S TOP TAPA SUPERIOR	01	6233	2364x448x12	01
BASE INFERIOR BOTTOM BASE BASE INFERIOR	01	6234	2364x448x12	01
BASE DO MALEIRO BASE FOR LUGGAGE RACK BASE DEL PORTAEQUIPAJES	01	6235	2364x448x12	01
BATENTE TOP SUPPORT BATIENTE	01	6238	373x090x12	03
BATENTE TOP SUPPORT BATIENTE	01	6239	373x50x12	03
LAT. DE GAVETA SIDE DRAWER LATERAL DE CAJÓN	01	9426	357x101x12	08
RODAPÉ FRONT BASEBOARD FRONT ZÓCALO FRONTAL	01	9749	2364x071x15	01
RODAPÉ TRAS BASEBOARD BACK ZÓCALO TRASERO	01	9750	2364x071x15	01
TAMPO DRAWER'S COVER TAPA DEL CAJÓN	01	9755	582x380x12	04
TAMPO DRAWER'S COVER TAPA DEL CAJÓN	01	9756	582x300x12	02
RODAPÉ CALÇO WEDGE BASEBOARD ZÓCALO CALZO	01	9759	416x071x12	02

DESCRIÇÃO DESCRIPTION DESCRIPCIÓN	VOLUME VOLUME VOLUMEM	NÚMERO NUMBER NÚMERO	DIMENSÃO DIMENSION DIMENSIÓN	QUANTIDADE QUANTITY CANTIDAD
TRASEIRO G.R WARDROBE'S BACKBOARD COSTADO DEL ROPERO	02	05	2050x294x2,5	08
PORTA DOOR PUERTA	02	9751	2032x294x15	08

DESCRIÇÃO DESCRIPTION DESCRIPCIÓN	VOLUME VOLUME VOLUMEM	NÚMERO NUMBER NÚMERO	DIMENSÃO DIMENSION DIMENSIÓN	QUANTIDADE QUANTITY CANTIDAD
FUNDO GAVETA DRAWER'S BOTTOM FONDO DEL CAJÓN	03	04	505x365x2,5	04
LAT. EXT. ESQUERDA LEFT EXTERNAL SIDE LAT. EXT. IZQUIERDA	03	9752	2190x448x12	01
LAT. EXT. DIREITA RIGHT EXTERNAL SIDE LATERAL EXTERNA DERECHA	03	9753	2190x448x12	01

RELAÇÃO DE PEÇAS
LIST OF PARTS • LISTA DE PARTES

DESCRIÇÃO DESCRIPTION DESCRIPCIÓN	VOLUME VOLUME VOLUMEM	NÚMERO NUMBER NÚMERO	DIMENSÃO DIMENSION DIMENSIÓN	QUANTIDADE QUANTITY CANTIDAD
LAT. INTERNA INTERNAL SIDE LAT. INTERNA	03	9454	1639x448x12	03
FRENTE GAVETA DRAWER'S FRONT FRENTE DEL CAJÓN	03	9757	524x170x12	04
TRASEIRO GAVETA DRAWER'S BACKBOARD TRASERO DE CAJÓN	03	9758	483x090x12	04

Ps: Peças e Complementos que não contém processo de furação não são enumeradas.
Parts and Accessories that do not contain drilling process and are not listed.
Piezas y Accesorios que no contienen procesos de perforación y que no numerados.

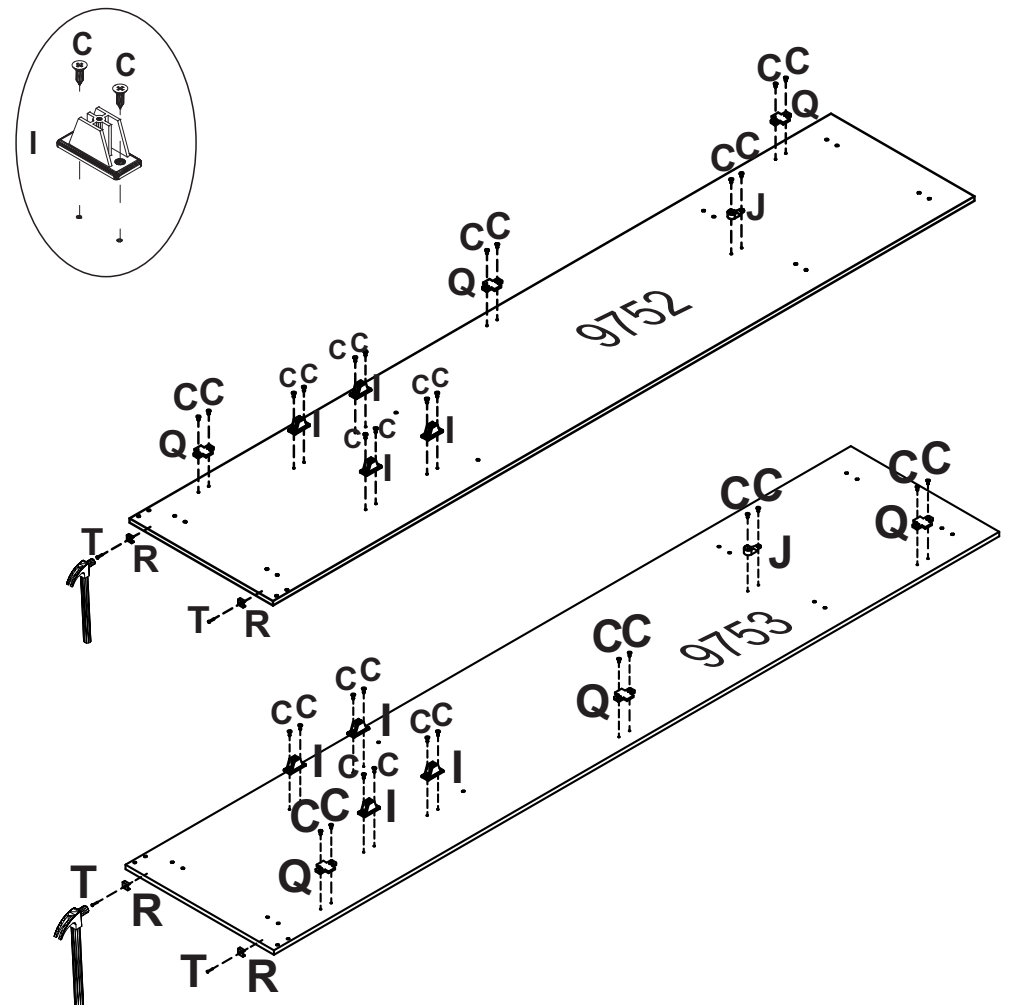

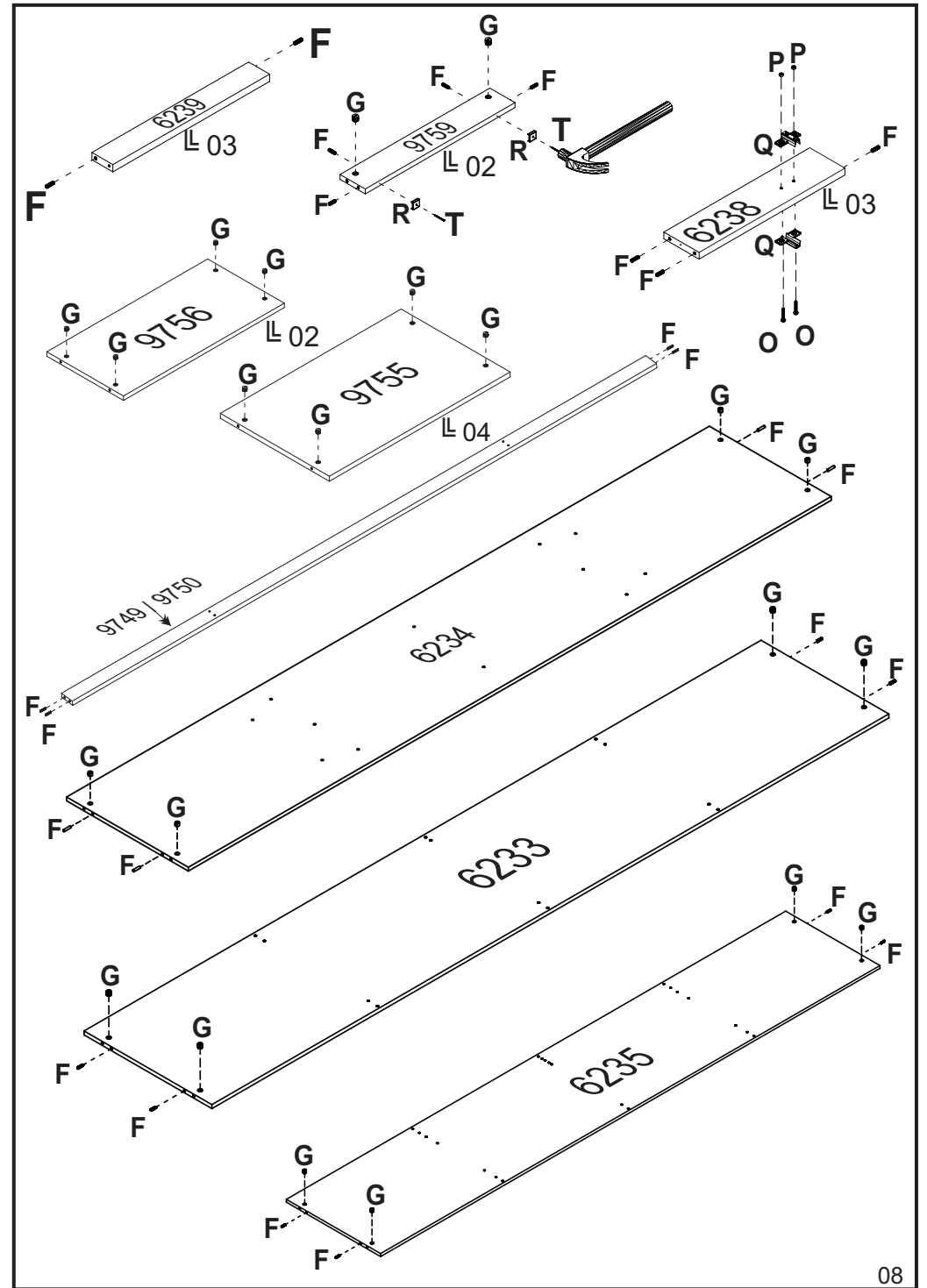
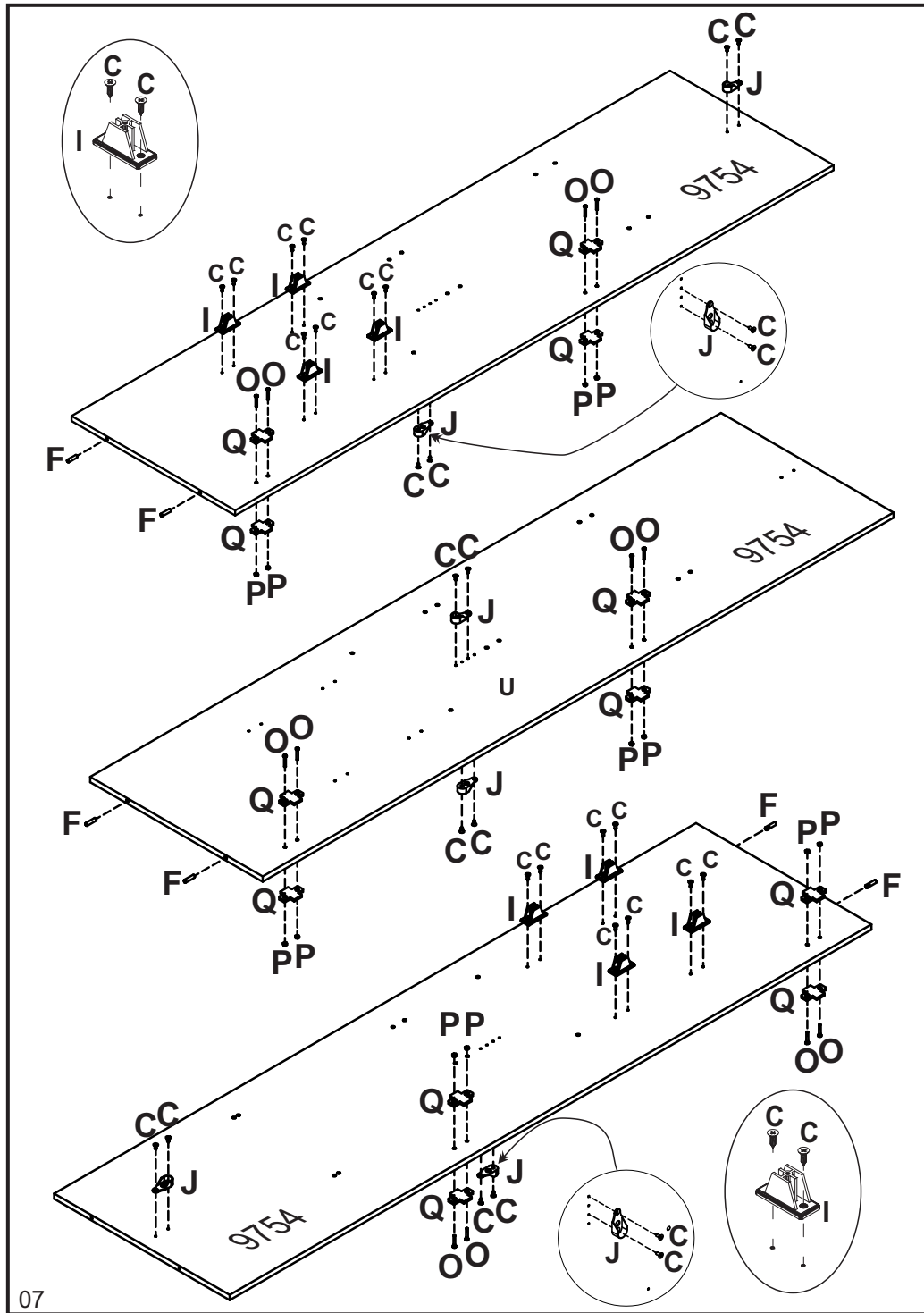

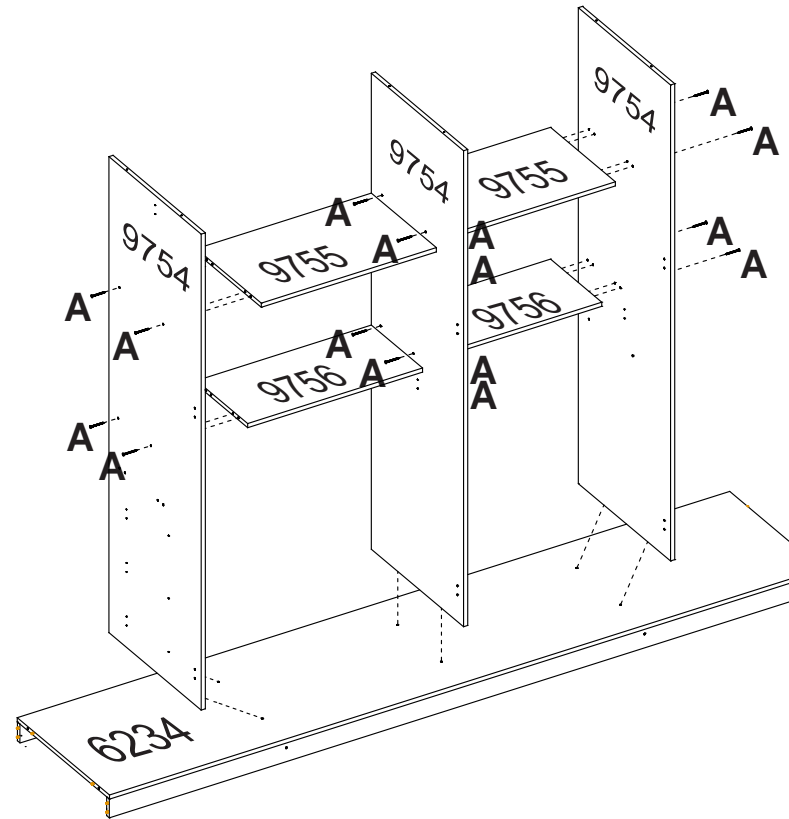
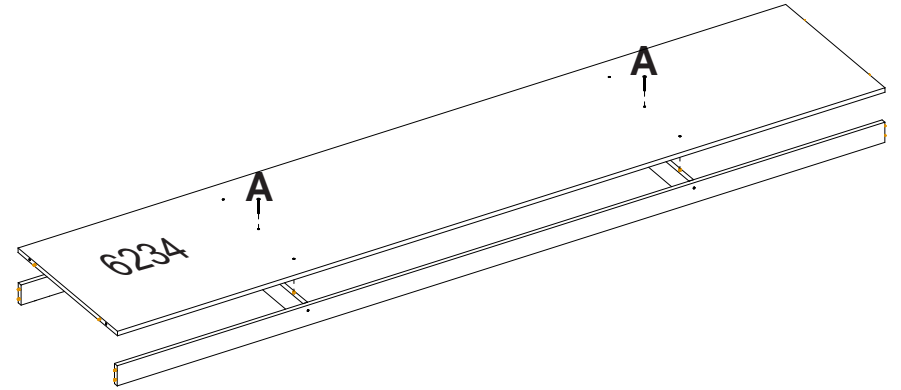
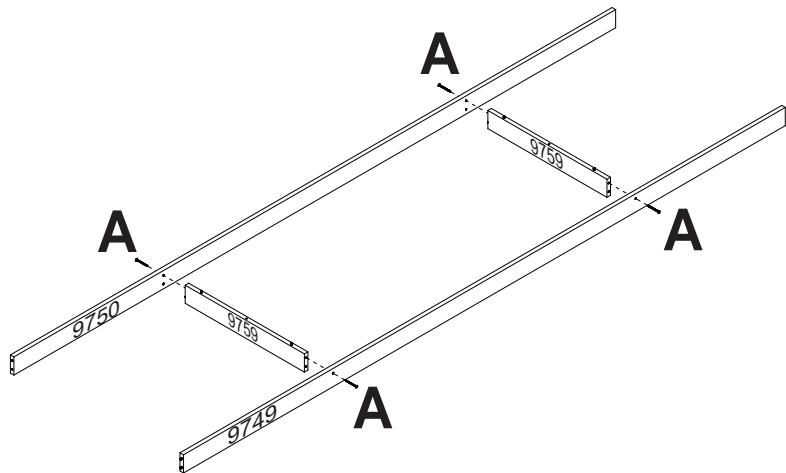
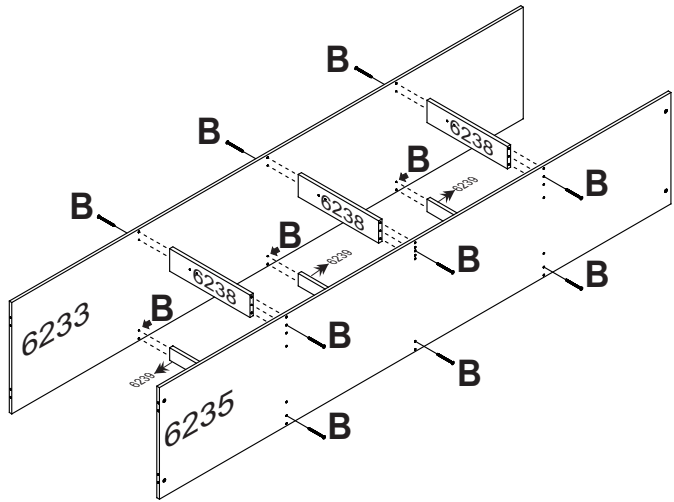

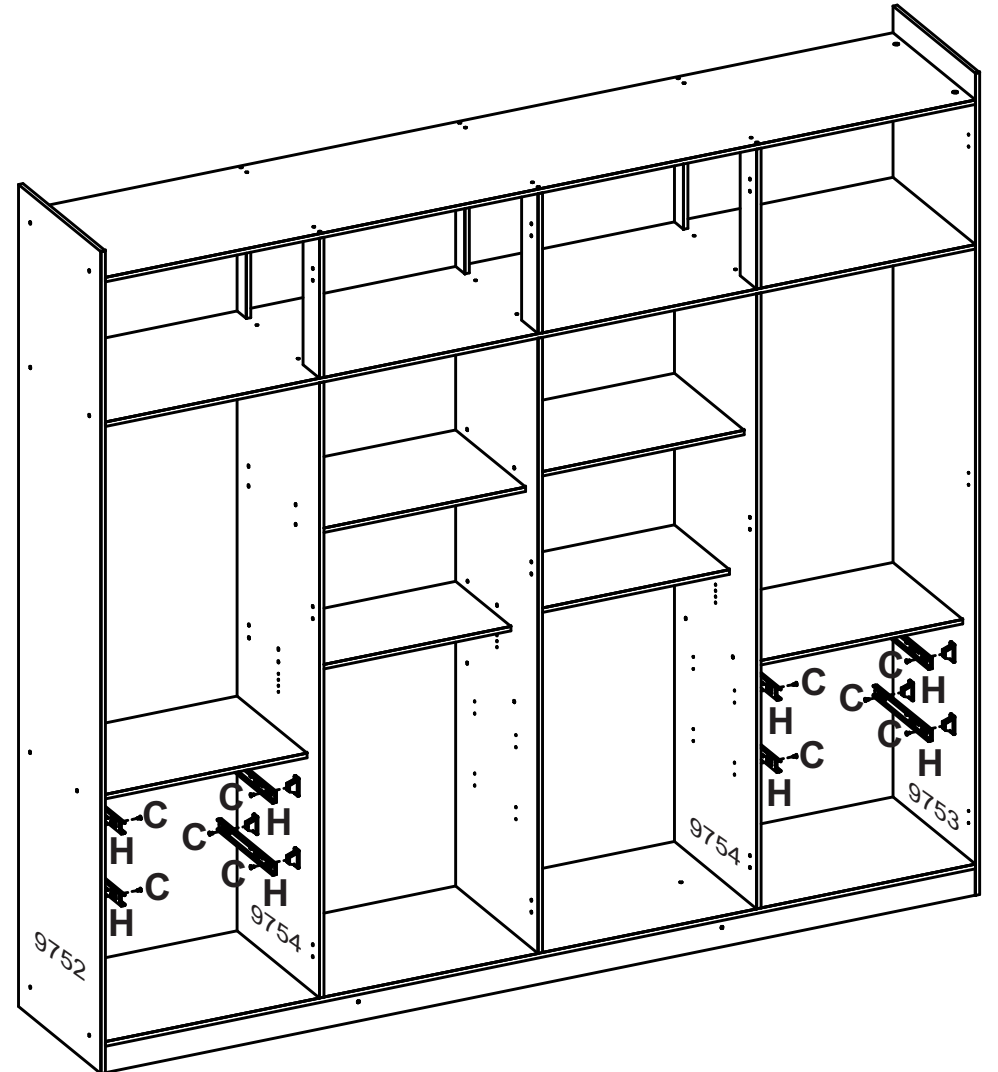
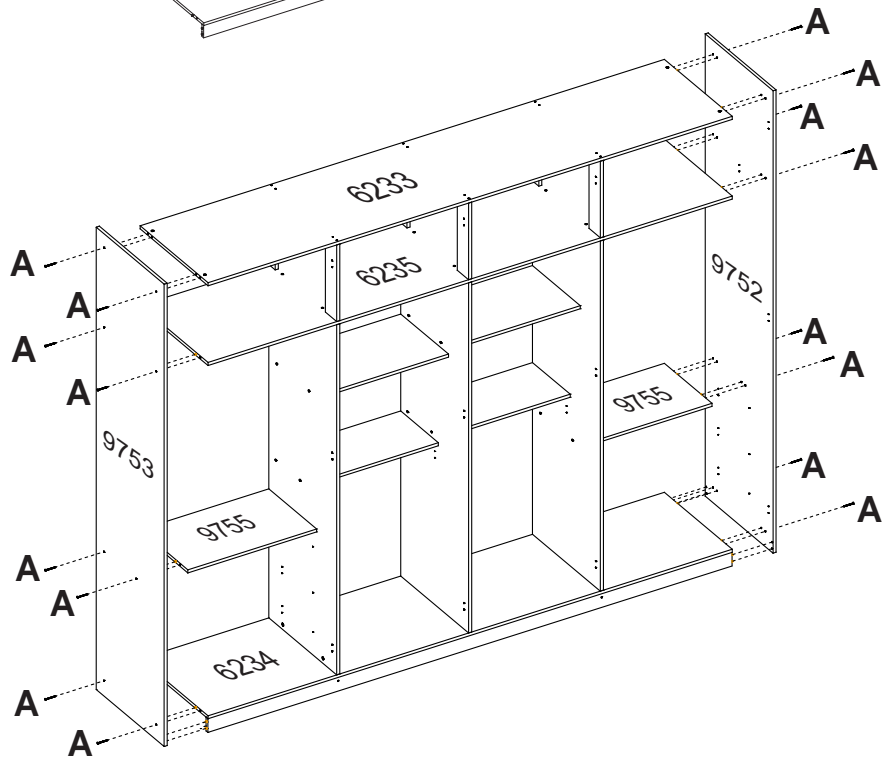
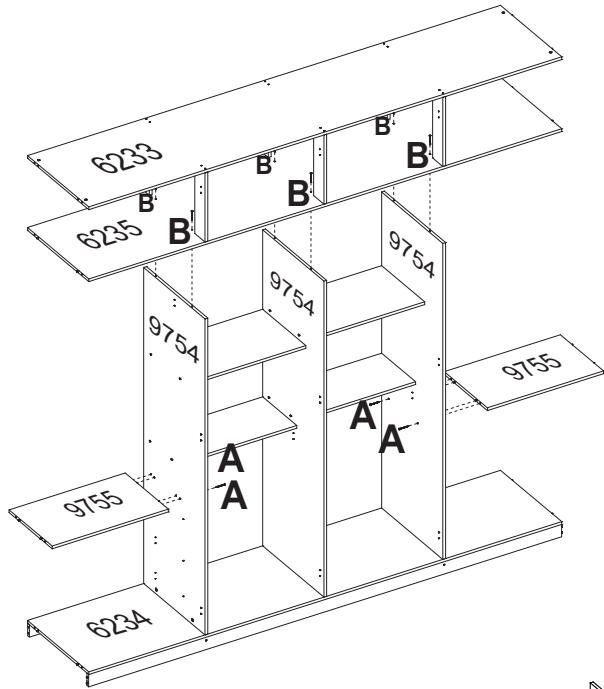

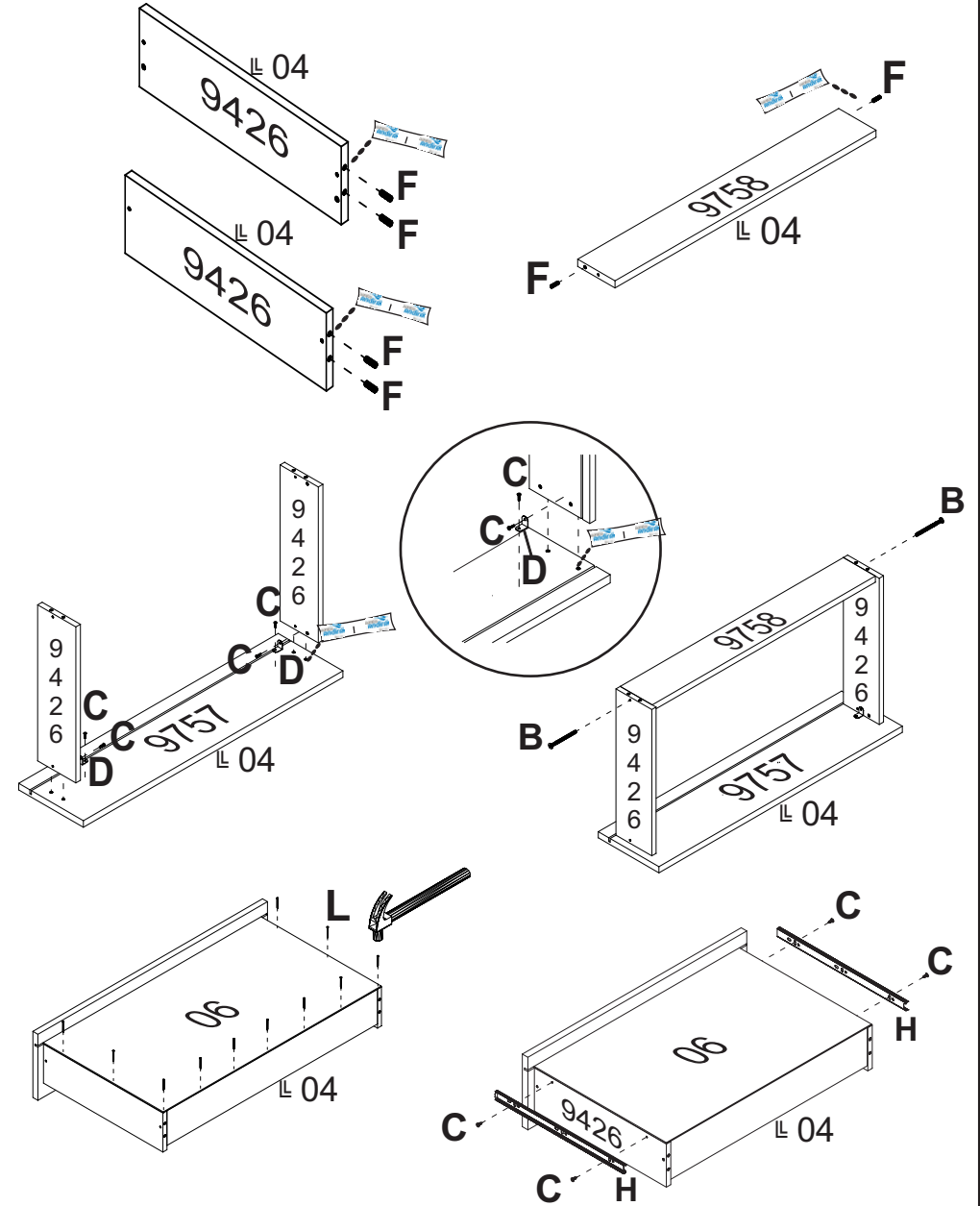
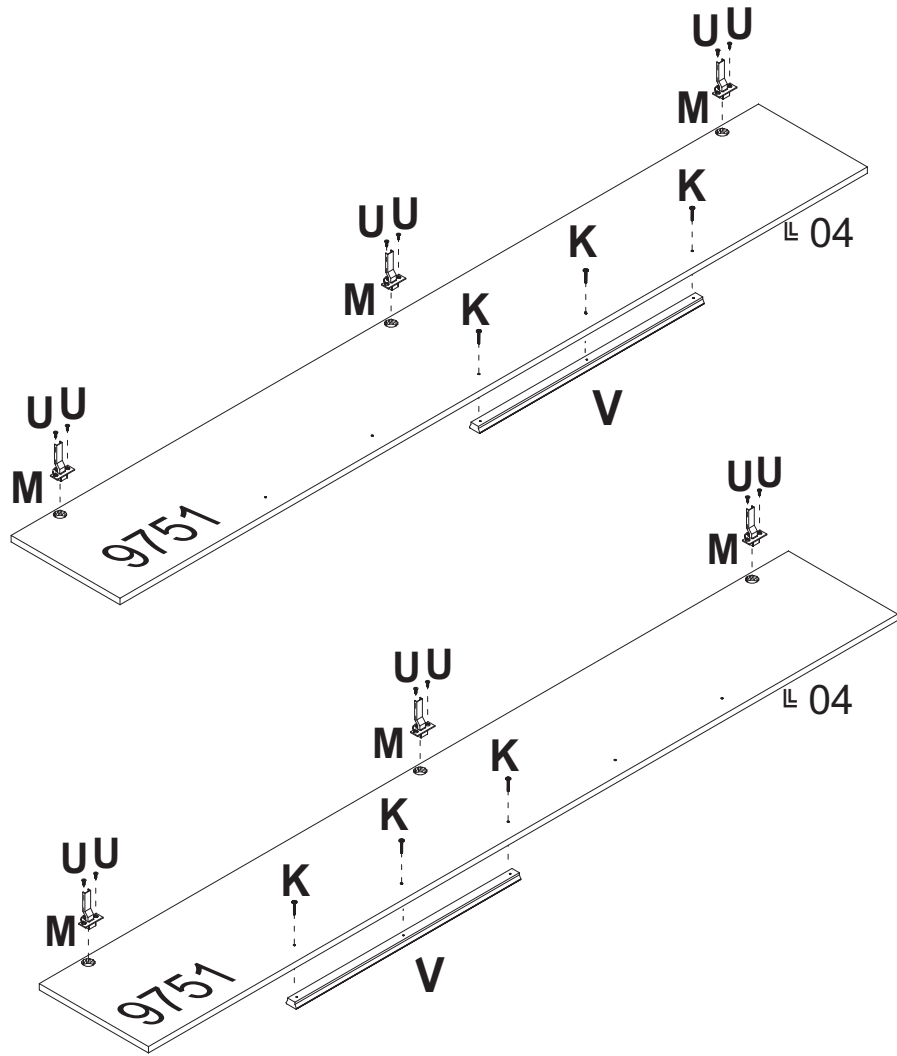

“Usar cola em todas as cavilhas”

“Use glue on all wood pegs”

“Utilizar cola en todos los tarugos de madera”

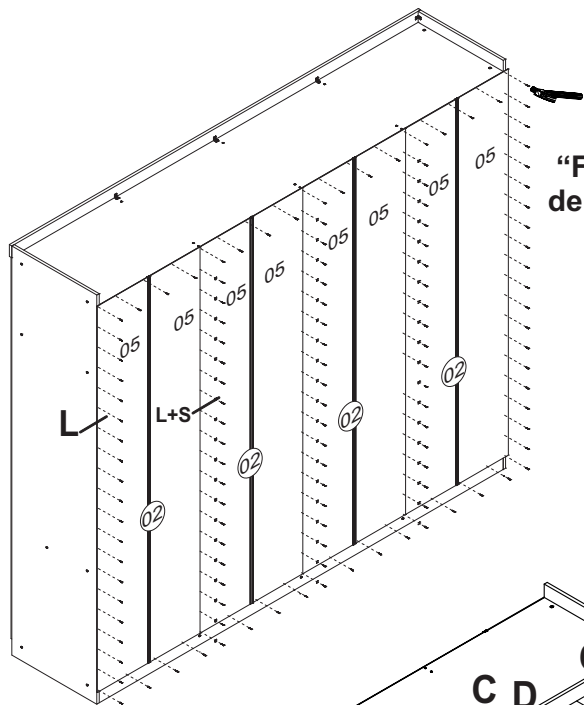

**“Fixar os pregos a (100mm)
de distância de um para outro”**

*“Fix nails to (100mm)
away from one to another”*

*“Fije los clavos a (100 mm)
lejos de uno a otro”*

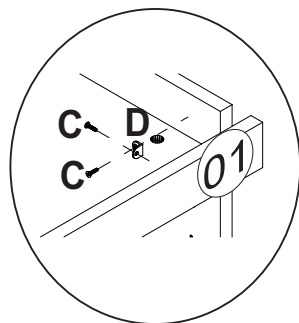
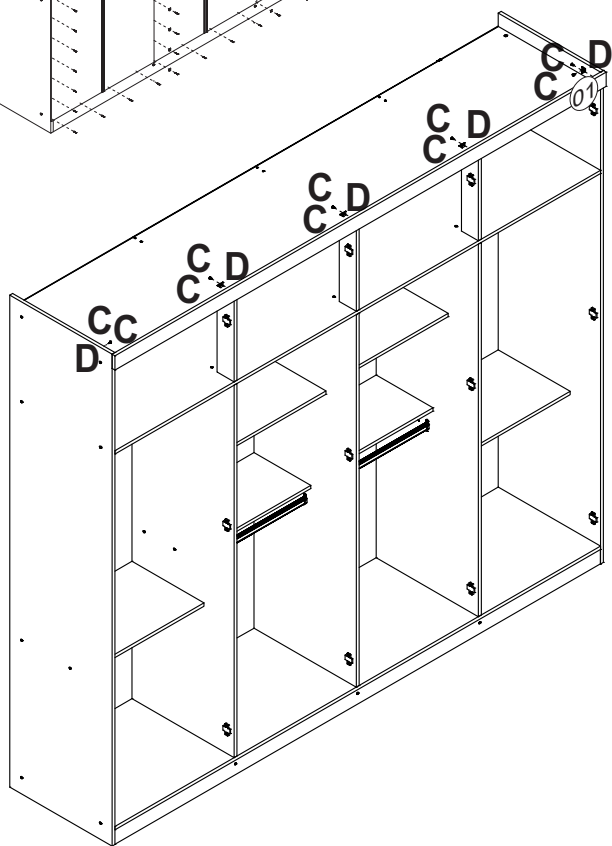

MEDIDA DO PRODUTO MONTADO

MEASURE OF THE ASSEMBLED PRODUCT
MEDIDA DEL PRODUCTO ENSAMBLADO

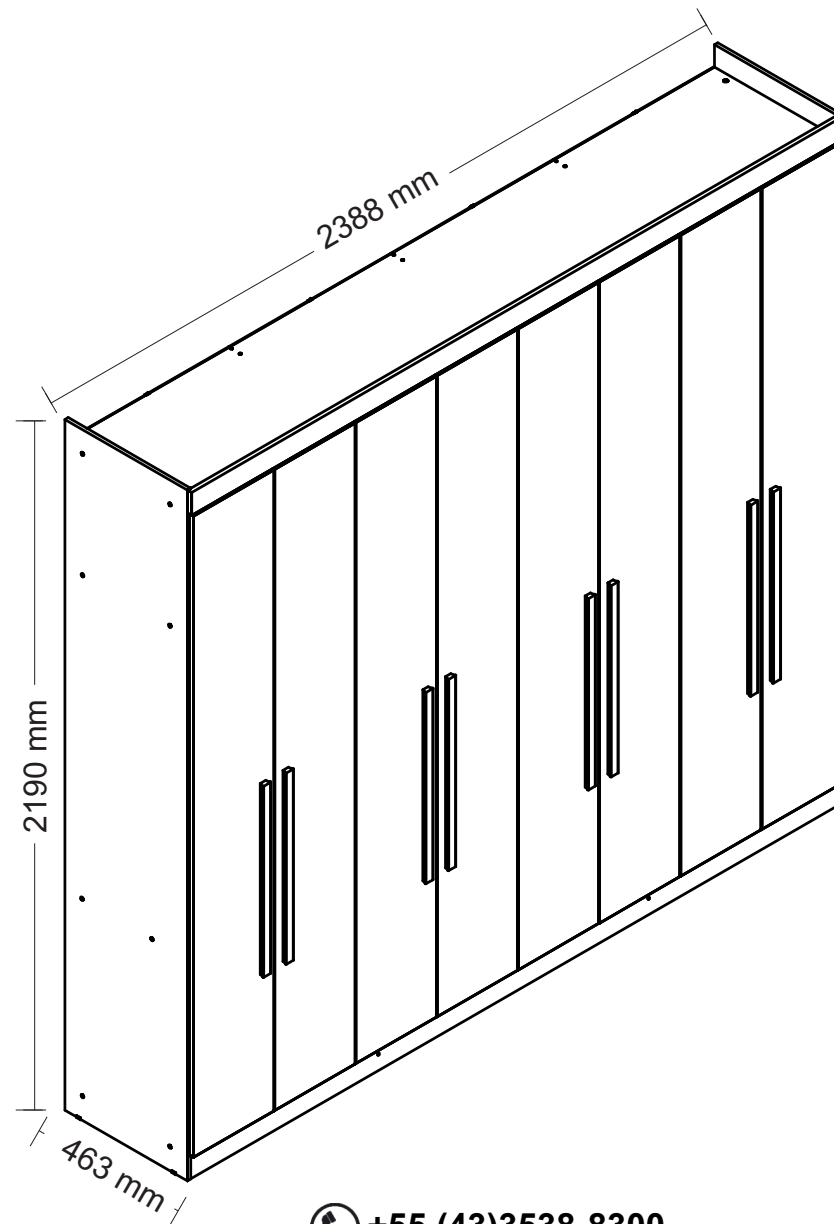

 **+55 (43)3538-8300**

Agora que você já comprou o seu móvel, ele merece ser montado do jeito certo.

Erros de montagem causam mais de **60%** dos danos em móveis.

Por que contratar?

Tranquilidade do **início ao fim** da montagem



PROFISSIONAIS QUALIFICADOS

Especialistas certificados na **MadeiraMadeira Serviços**.



FERRAMENTAS PROFISSIONAIS

que **protegem** seus móveis.



AGENDAMENTO EM 24 HORAS

escolha a data e o turno **ideais para** você.



GARANTIA DE 3 MESES

de cobertura **completa**.

Mais de 1 MILHÃO DE MONTAGENS
★ com avaliação 4.7 ★

Mariana S., São Paulo

"Chegaram no horário e montaram tudo rapidamente. Serviço incrível!"



Carlos R., Belo Horizonte

"Tentei montar sozinho e foi um desastre. Com a **MadeiraMadeira Serviços** ficou perfeito."



Ana P., Rio de Janeiro

"Agendamento ágil e **montagem pontual e perfeita**. Recomendo demais!"



Agende agora pelo
QR Code

Madeira**Madeira** Serviços · Atendimento em todo o Brasil



Escaneie o QRCode