

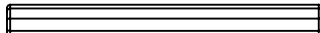









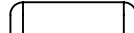
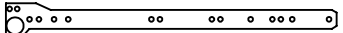
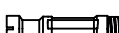

BL2001

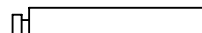
REVISÃO/REVISIÓN/REVISION:01

INSTRUÇÕES DE MONTAGEM
INSTRUCCIONES DE MONTAJE
ASSEMBLY'S INSTRUCTIONS**Faema**
MÓVEIS**BALCÃO COM 2 GAVETAS E 1 PORTA**
BALCÓN CON 2 CAJÓN Y 1 PUERTA
COUNTER WITH 2 DRAWERES AND 1
DOOR**LISTA DE PEÇAS / LISTA DE PIEZAS / FURNITURE PIECES LIST**

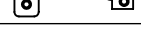
COD	DESCRIÇÃO/DESCRIPCIÓN/DESCRIPTION	DIMENSÃO/DIM/DIM	QTD
01	LATERAL ESQUERDA/ LATERAL IZQUIERDO/ LEFT SIDE	685X400X15	01
02	DIVISÓRIA/ DIVISIÓN/ DIVISION	670X400X15	01
03	TAMPO/ TAPA/ TOP	801X400X15	01
04	BASE/ BASE/ BASE	770X400X15	01
05	LATERAL DIREITA SUPERIOR/ LATERAL DERECHO/ RIGHT SIDE	213X400X15	01
06	LATERAL DIREITA INFERIOR/ LATERAL DERECHO/ RIGHT SIDE	228X400X15	01
07	PRATELEIRA/ ESTANTE/ SHELF	384X384X15	01
08	PORTA/ PUERTA/ DOOR	635X377X15	01
09	LATERAL DE GAVETA/ LATERAL DEL CAJÓN/ SIDE OF THE DRAWER	350X80X15	04
10	TRASEIRA DE GAVETA/ TRASERA DEL CAJÓN/ BACK OF THE DRAWER	343X64X15	02
11	FRENTE DE GAVETA/ FRENTE DEL CAJÓN/ FRONT OF THE DRAWER	178X362X15	02
12	TRAVESSA/ TRAVESANÕ/ CROSSPIECE	370X45X15	02
13	TRAVESSA/ TRAVESANÕ/ CROSSPIECE	385X45X15	01
14	PRATELEIRA SUPERIOR/ ESTANTE/ SHELF	385X400X15	01
15	PRATELEIRA INFERIOR/ ESTANTE/ SHELF	385X400X15	01
16	COSTA/ FONDO/ BACK	694X393X3	01
17	COSTA/ FONDO/ BACK	694X404X3	01
18	FUNDO DE GAVETA/ FONDO DEL CAJÓN/ BOTTON OF TRE DRAWER	325X367X3	02

REF	DESCRIÇÃO	QTD
A	 CAVILHA/ CLAVIJA/ WOOD DOWEL 8x50MM	02
B	 CAVILHA/ CLAVIJA/ WOOD DOWEL 8x30MM	42
C	 PARAFUSO/ TORNILLO/ SCREW 3,5x14 CC	32
D	 PARAFUSO/ TORNILLO/ SCREW 3,5x40 CC	14
E	 PARAFUSO/ TORNILLO/ SCREW 4,5x50 CF	04
F	 COLA/ PEGAMENTO/ GLUE	01
G	 CORREDEÇA/ CORREDERA/ SLIDE 350 MM	02
H	 PARAFUSO MINIFIX/ TORNILLO MINIFIX/ MINIFIX SCREW	08
I	 TAMBOR MINIFIX/ TORNILLO MINIFIX/ MINIFIX DRUM 12MM	08
J	 PARAFUSO/ TORNILLO/ SCREW 6x10 CC	08
K	 PÉ/ PIE/ FOOT	04
L		01
M	 CANTONEIRA/ ESQUINERO/ CORNER	08
N	 DOBRADIÇA/ BISAGRA/ HINGE (CANECO 26 CALÇO 12)	02
O	 PREGO/ CLAVO/ NAIL 10X10	37
P	 ADESIVO TAPAFURO / ADHESIVO/ STICKER 15MM	06
Q	 FIXADOR PARA COSTAS/ FIJADOR PARA FONDO/ BACK SUPPORT	03

**PESO MÁXIMO SUPORTADO PELO PRODUTO 45 KG**
PESO MÁXIMO SOPORTADO POR EL PRODUCTO 45 KG
MAXIMUM WEIGHT TOLERATED BY THE PRODUCT 45 KG**IMPORTANTE LER COM ATENÇÃO E GUARDAR PARA EVENTUAIS CONSULTAS.**
IMPORTANTE LEER CON ATENCIÓN Y GUARDAR PARA EVENTUALES CONSULTAS.
IMPORTANT TO READ CAREFULLY AND SAVE FOR ANY QUERIES.**FERRAMENTAS NECESSÁRIAS:**
HERRAMIENTAS NECESARIAS:
NECESSARY TOOLS:

RECOMENDAÇÕES:

01 - Examine completamente todas as peças do móvel antes de iniciar o trabalho.

02 - Recomenda-se montar o móvel conforme este Manual de Montagem.

03 - É de responsabilidade do montador seguir as instruções do Manual de Montagem, que são fundamentais para garantir a estrutura do móvel.

04 - Certifique-se de que todos os acessórios utilizados na montagem (parafusos, porcas, ponteiros) estejam fixados o suficiente, totalmente atarraxados, evitando que venham a provocar ferimentos.

LIMPEZA:

01 - Pano levemente umedecido com água, seguido de pano seco.

02 - Não utilizar produtos químicos ou abrasivos.

GARANTIA:

01 - 3 meses para defeitos ou vícios de origem.

ADVERTÊNCIAS:

01 - Esteja ciente do risco de chama aberta e outras fontes de calor, tais como aquecedores elétricos, aquecedores a gás etc. nas proximidades do produto.

02 - Não utilize o produto se alguma parte estiver quebrada, rasgada ou faltando. Utilizar somente peças de reposição aprovadas pelo fabricante.

RECOMENDACIONES:

01 - Examine completamente todas las piezas del mueble antes de empezar el montaje.

02 - Recomienda-se montar el mueble de acuerdo con este Manual de Montaje.

03 - Es de responsabilidad del montador seguir las instrucciones del Manual de Montaje, que son fundamentales para asegurar la estructura del mueble.

04 - Asegure-se de que todos los accesorios utilizados en el montaje (tornillos, tuercas, ponteras) estén fijados el suficiente, totalmente roscados, evitando que vengam a provocar lesiones.

LIMPIEZA:

01 - Paño levemente humedecido con agua, siguiendo de paño seco.

02 - No utilizar productos químicos o abrasivos.

GARANTÍA:

01 - 3 meses para defectos o vicios de origen.

ADVERTENCIAS:

01 - Tenga en cuenta el riesgo de llama abierta y otras fuentes de calor, tales como calentadores eléctricos, calentadores de gas, etc. en las proximidades del producto.

02 - No utilice el producto si alguna parte esté rota, o perdida. Utilizar sólo piezas de repuesto aprobadas por el fabricante.

RECOMMENDATIONS:

01 - Check completely all the furniture's pieces before start to assemble it.

02 - It is recommended to assemble this furniture according to this Assembly's Manual.

03 - It is the assembler's responsibility to follow the instructions of this Assembly's Manual, which are essential to ensure the furniture's structure.

04 - Ensure that all the accessories used in the assembly (bolts, nuts, tips) are well and enoughly fixed, completely threaded, avoiding injuries from happening.

CLEANSING:

01 - Cloth slightly moistened with water.

02 - Do not use chemicals or abrasives products.

WARRANTY:

01 - 3 months due to manufacture defects.

WARNINGS:

01 - Be aware of the risk of open flame and other sources of heat, such as electric heaters, gas heaters etc. around the product.

02 - Do not use the product if any part is broken, torn or missing. Only use replacement parts approved by the manufacturer.

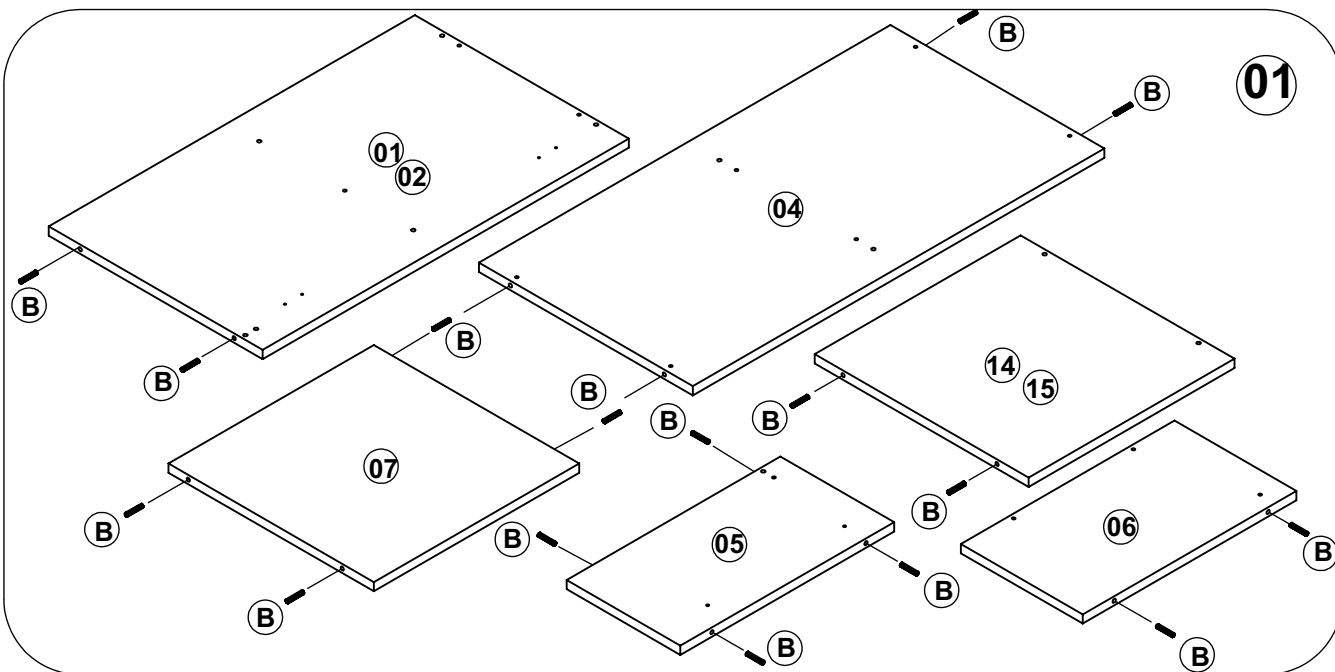

01

COLOCAR COLA "F" NAS CAVILHAS "B".
 COLOCAR PEGAMENTO "F" EN LAS CLAVIJAS "B".
 PLACE GLUE "F" ON DOWELS "B".

02

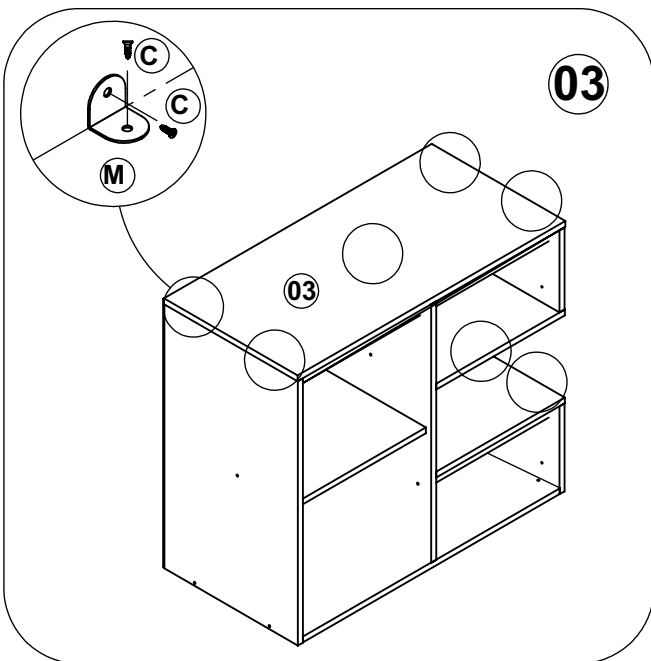
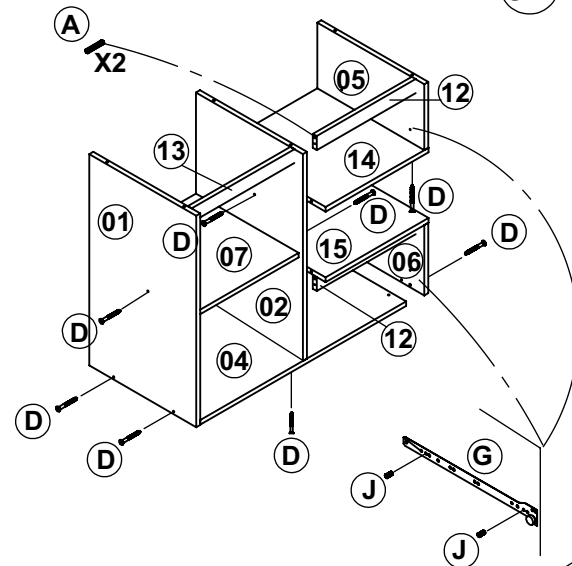

03

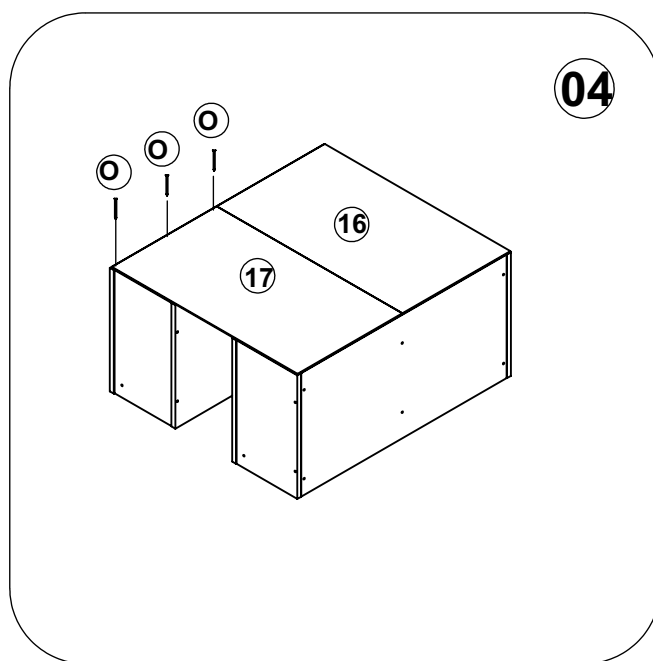

04

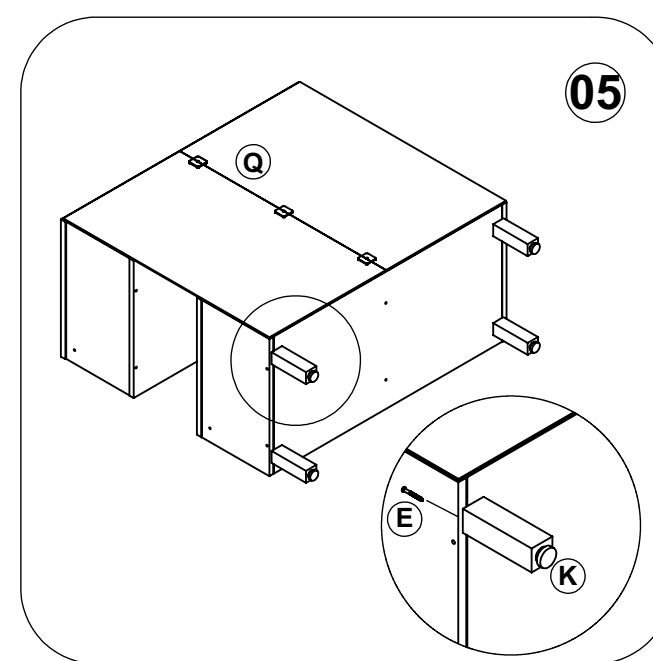

05

