

**Estante para livros  
London**

## Informações Utéis

Para assegurar a garantia, é recomendada a prévia conferência das peças e componentes, bem como a leitura do manual de montagem.

Qualquer dúvida sobre os nossos produtos você pode entrar em contato via nosso canal de atendimento:

### Limpeza

- Para começar a limpeza, retire o pó com flanela seca, depois use um pano macio, levemente umedecido com água. É possível o uso de detergente neutro, ou sabão neutro com água;
- De tempos em tempos, reaperte os parafusos do produto para garantir sua estabilidade e durabilidade;
- Tenha cuidado com a disposição de aparelhos eletrônicos sobre o móvel, a falta de ventilação e excesso de calor podem prejudicar a durabilidade e acabamento do seu produto.

Para mais dicas amigas e inspirações de decoração acesse nosso blog: <https://www.madeiramadeira.com.br/central-de-dicas>

### Siga MadeiraMadeira:



madeiramadeira.com.br

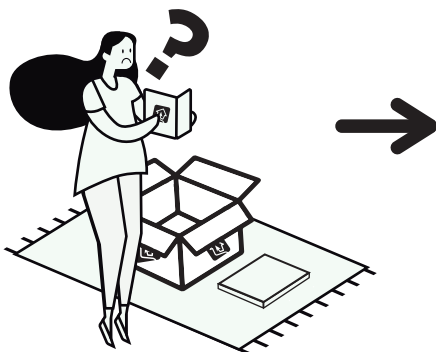
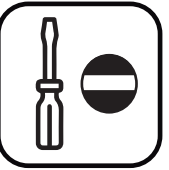
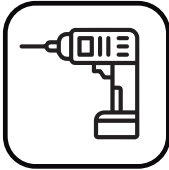
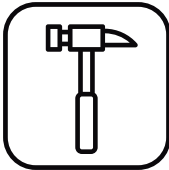

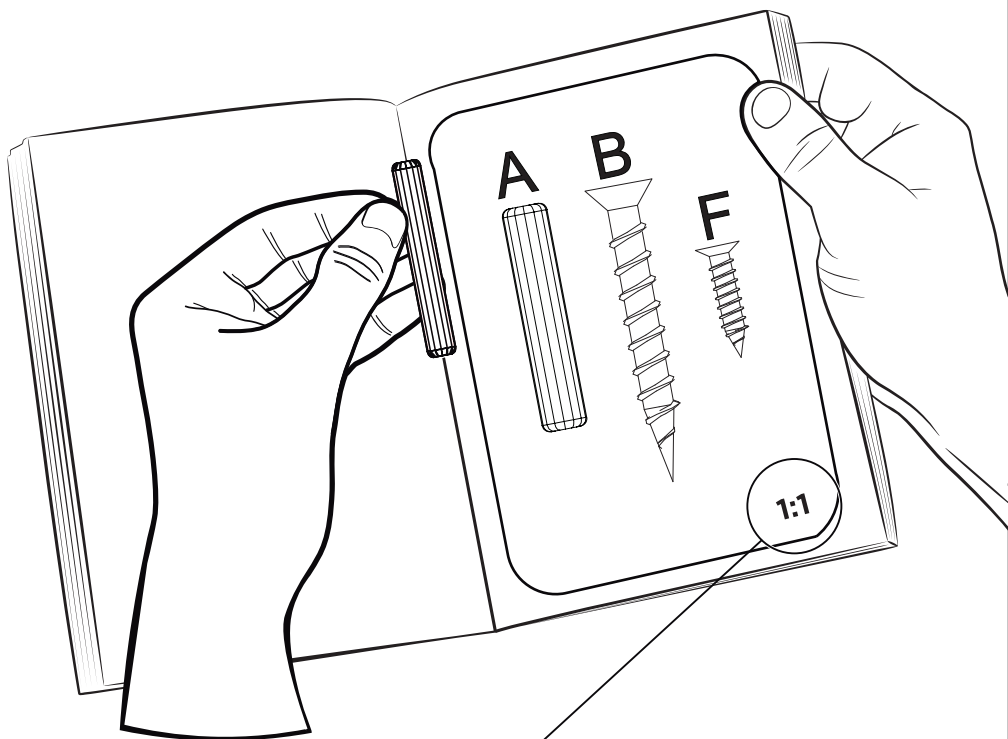

## Preste Atenção!

As ferragens dos nossos manuais são sempre apresentadas nas mesmas proporções da peça na vida real. Caso apareça alguma dúvida no decorrer do processo de montagem, coloque a ferragem ao lado do desenho e faça a consulta :D



## Símbolos:

- + Parafuso Phillips
- Parafuso Fenda
- ⬡ Parafuso Allen



**A : CAVILHA Ø6X30MM:  
52 uni.**

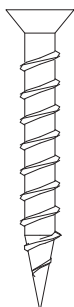

**B : PARAFUSO 3,5X40MM:  
20 uni.**



**C : PREGO 10X10: 60 uni.**

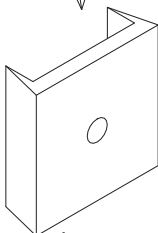

**D : Sapata 15x15mm: 8 uni.**



**E : Fixador fundo: 18 uni.**



**F : Cantoneira 2 furos: 12 uni.**



**G : Parafuso 3,5x14: 24 uni.**



**H : Tapa Furo: 18 uni. **1:1****

# LISTA DE PEÇAS

Nº PEÇA	DESCRIÇÃO	QTD	DIMENSÕES (mm)			PESO UNT (KG)
			COMP.	LARG.	ESP.	
1	LATERAL DIREITA	01	1375	300	15	4,04
2	LATERAL ESQUERDA	01	1375	300	15	4,04
3	DIVISÓRIA ESQUERDA	01	1375	300	15	4,04
4	DIVISÓRIA DIREITA	01	1375	300	15	4,04
5	PRATELEIRAS	11	430	300	15	1,26
6	TAMPO	01	1360	300	15	4,00
7	FUNDOS 3MM	3	1330	446,7	3	2,00

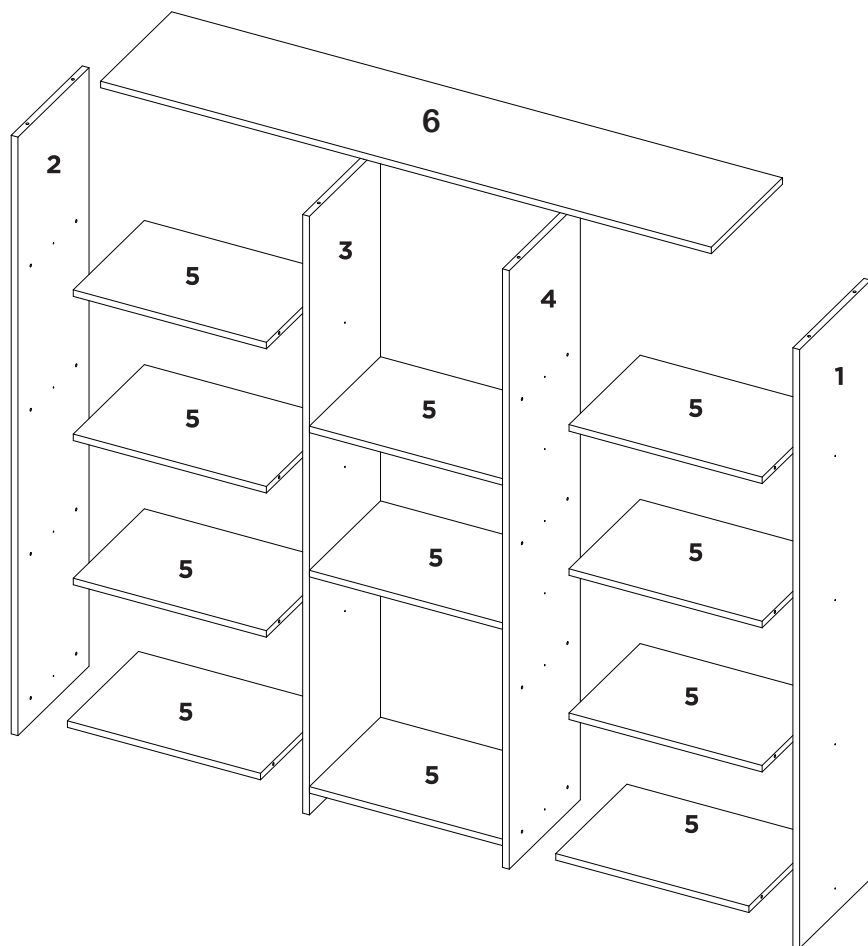

# 1

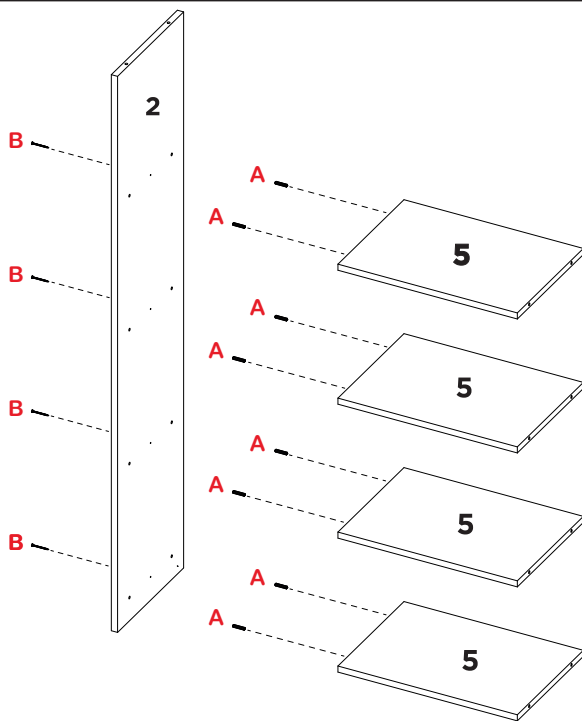

# 2

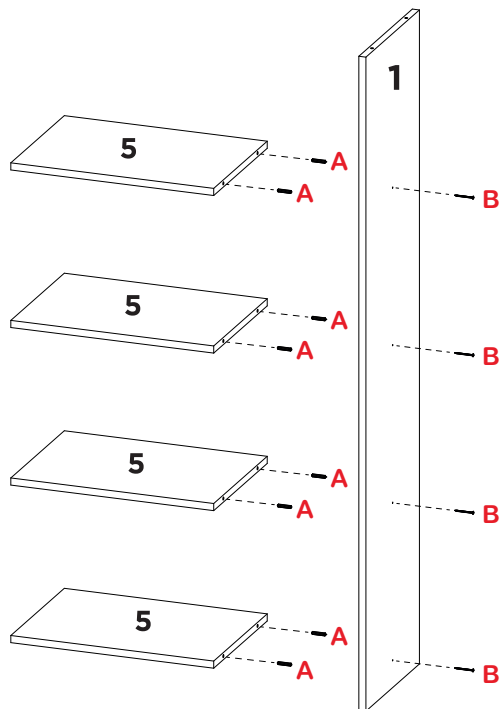

# 3

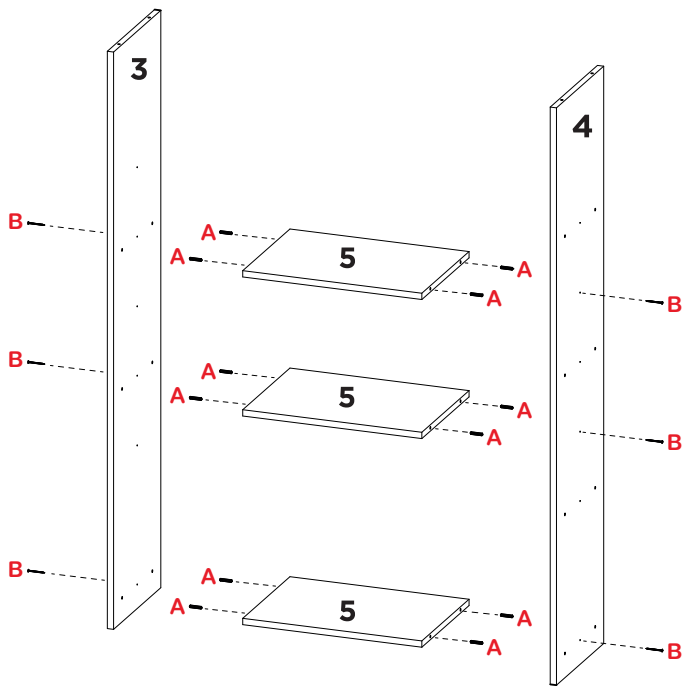

# 4

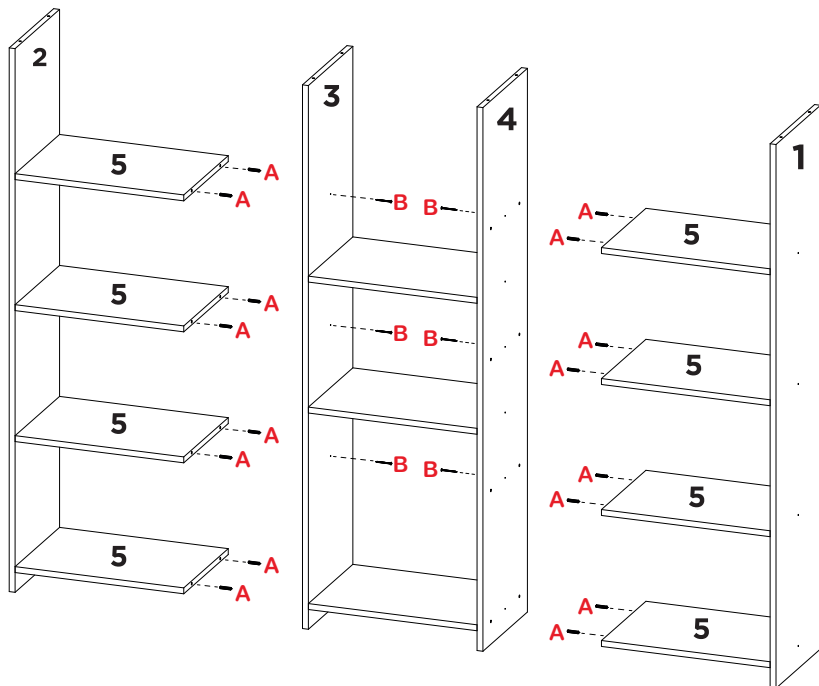



# 5

## 6

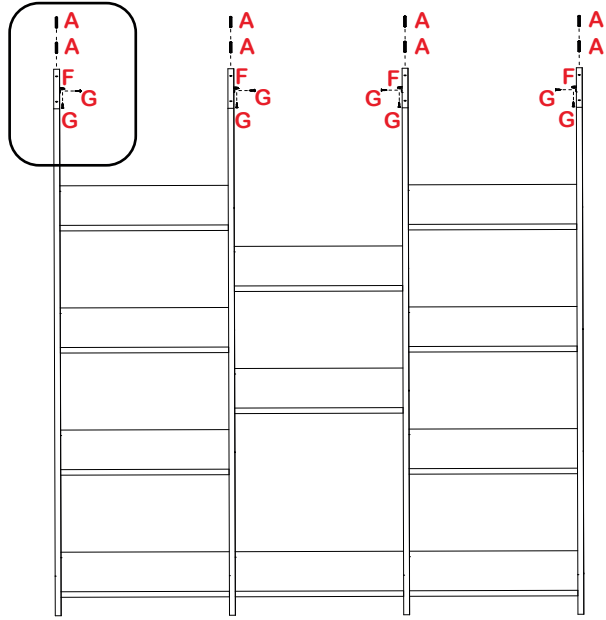
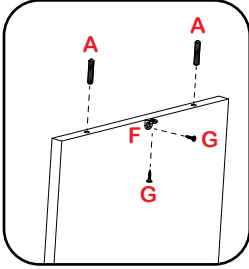

# 6

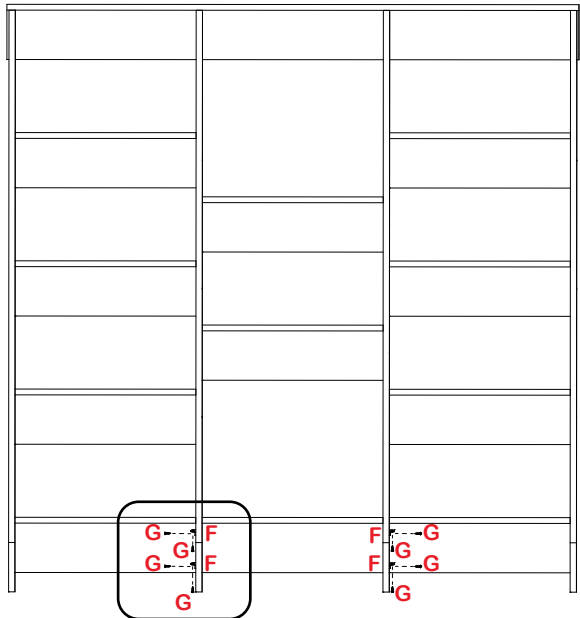
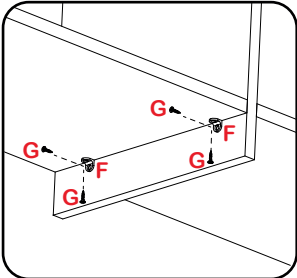

# 7

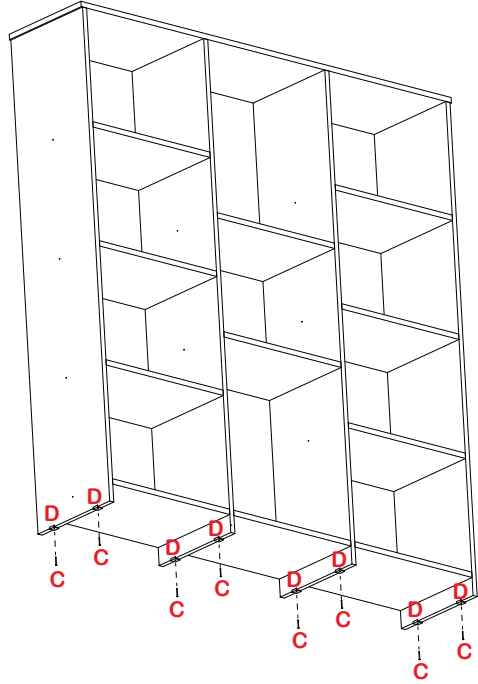
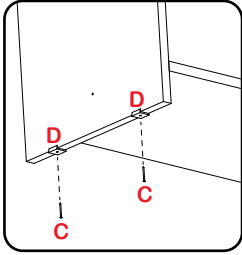

# 8

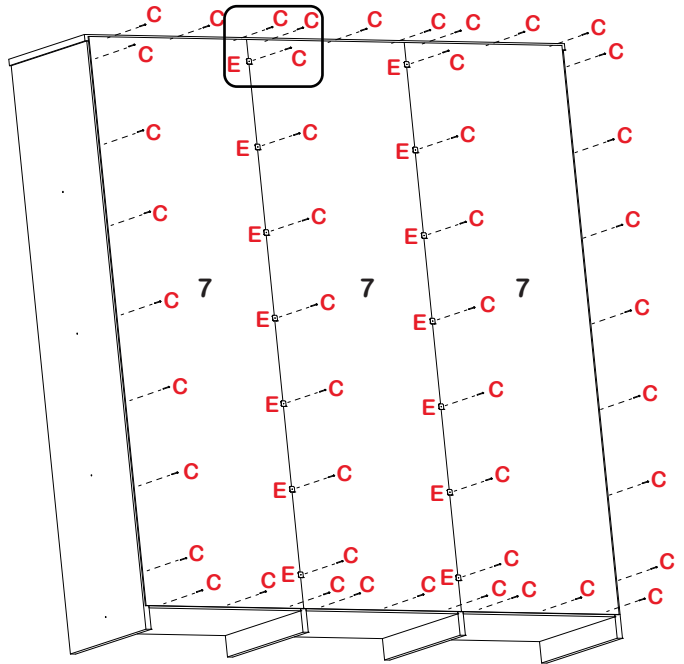
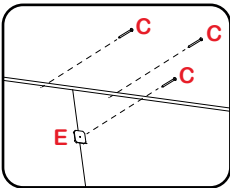

# 9

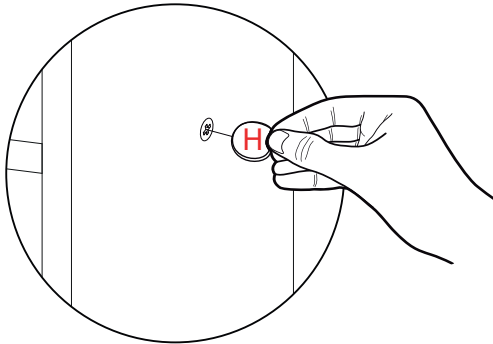
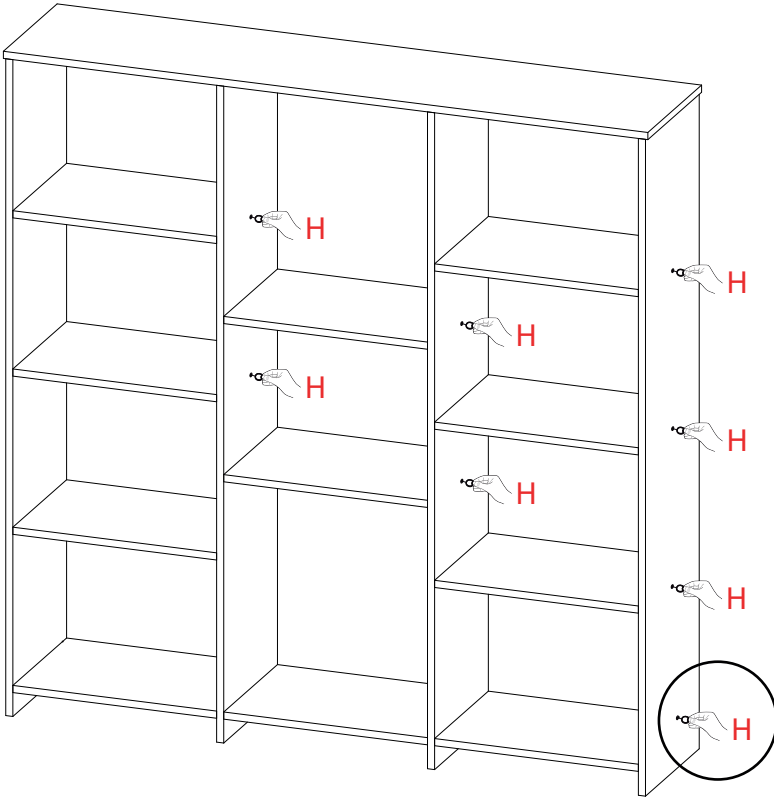

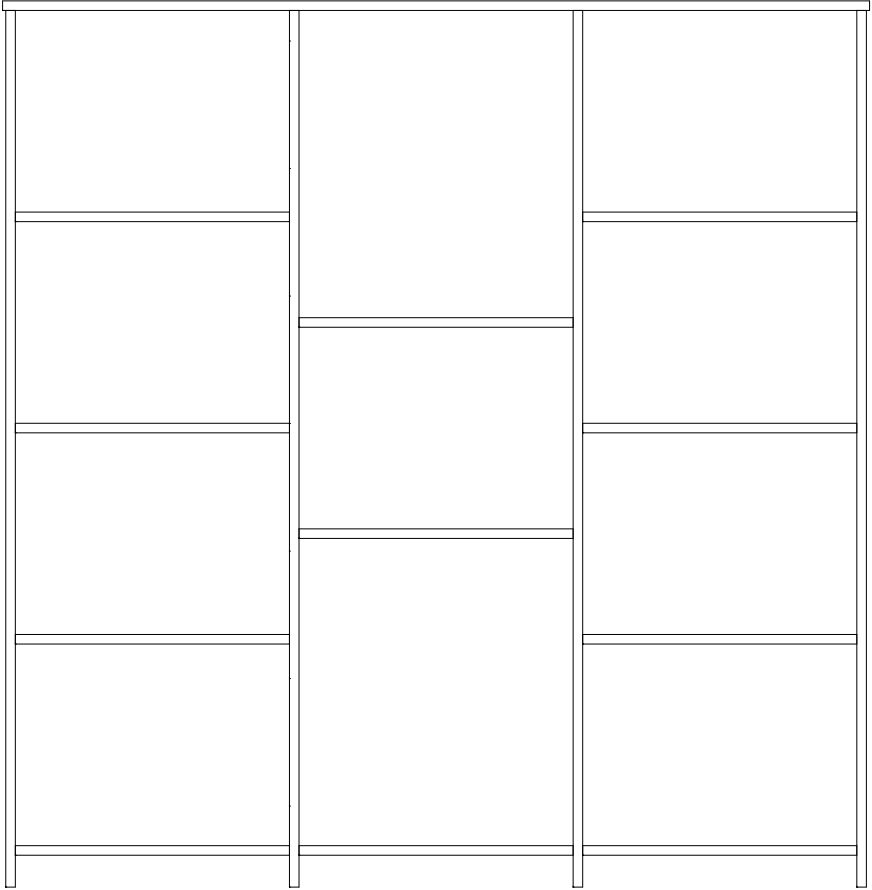



**yes casa**