

# GR. VERONA 6.2

WARDROBE VERONA 6.2  
ROPERO VERONA 6.2

## ESQUEMA DE MONTAGEM 949301

ASSEMBLING INSTRUCTIONS  
MANUAL DE ARMADO

santos  
**Andirá**

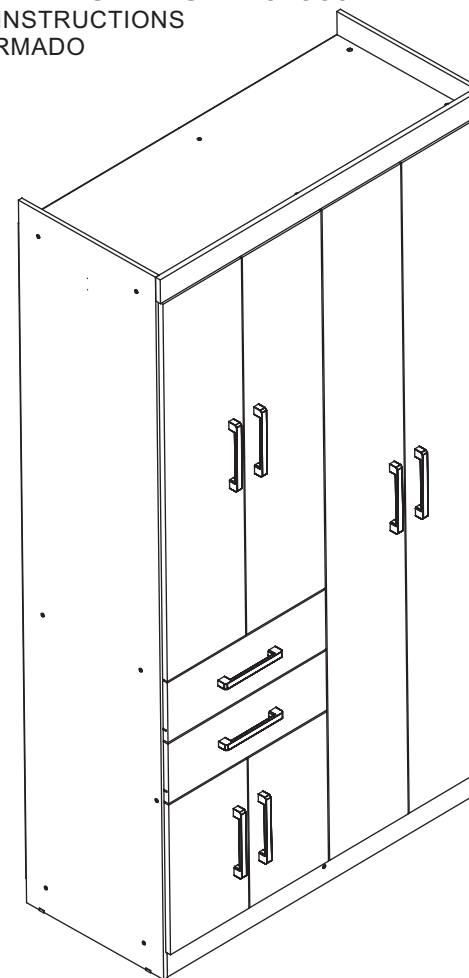

120 minutos  
120 minutes

- 162127 • CASTANHA/OFF WHITE
- 162158 • ATACAMA/GRAFITE
- 162166 • BRANCO/BRANCO
- 162199 • EBANO/EBANO

[www.santosandira.com.br](http://www.santosandira.com.br)

### AVISO

**Para limpeza do seu móvel utilize flanela seca ou levemente umedecida, sem produtos químicos!**

### WARNING

*To clean your mobile use dry cloth or slightly moistened, no chemicals!*

### ADVERTENCIA

*Para limpiar su mueble use un paño seco o ligeramente humedecido, sin productos químicos!*



ISO 14001



ISO 9001



**Descarte os resíduos de forma seletiva!**

*Dispose of waste selectively!*

*¡Deseche los residuos de manera selectiva!*

**Em caso de produto com espelho siga as instruções abaixo:**

*In the case of a product with a mirror, follow the instructions below*

*En el caso de un producto con espejo, siga las instrucciones a continuación:*

**Cole os espelhos na porta e aguarde cerca de 01 hora para fazer a colocação da mesma no produto.**





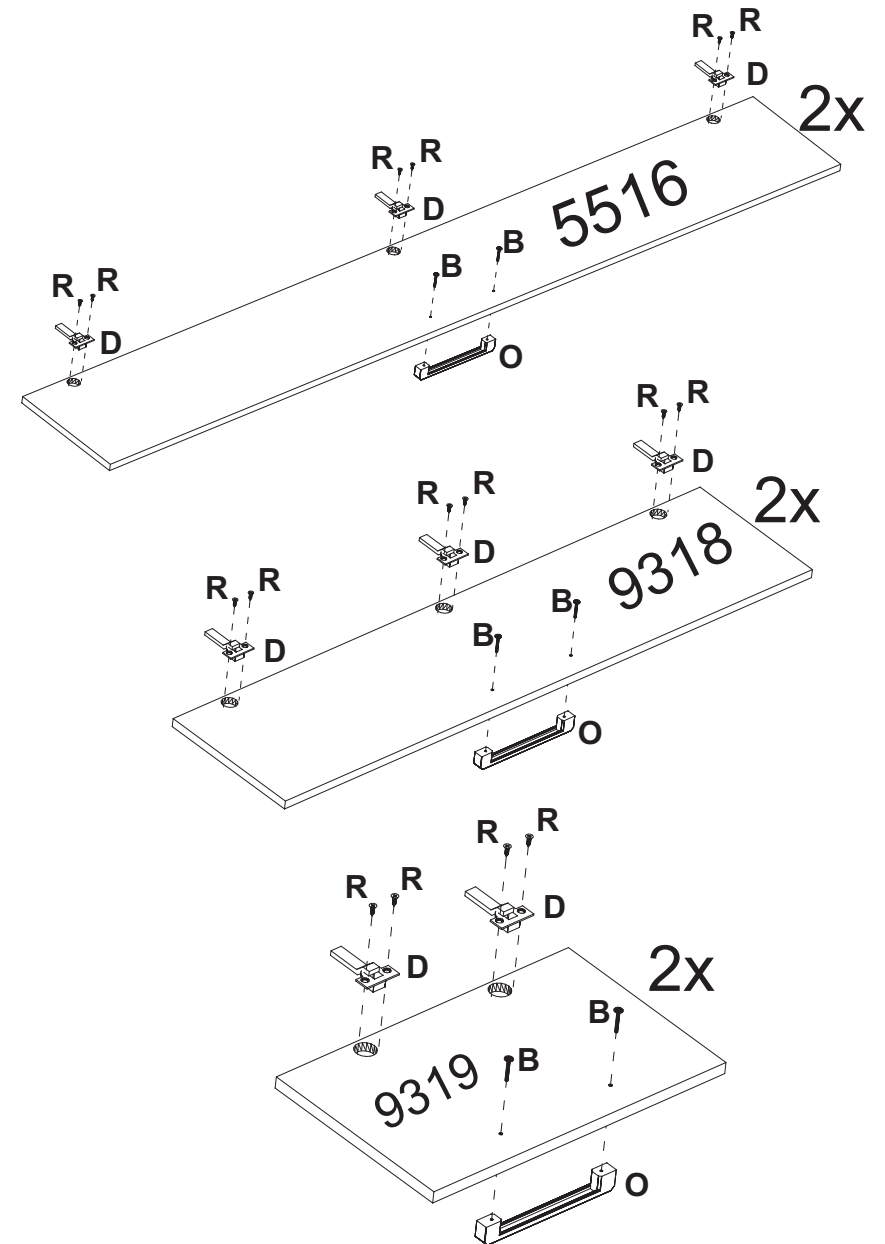

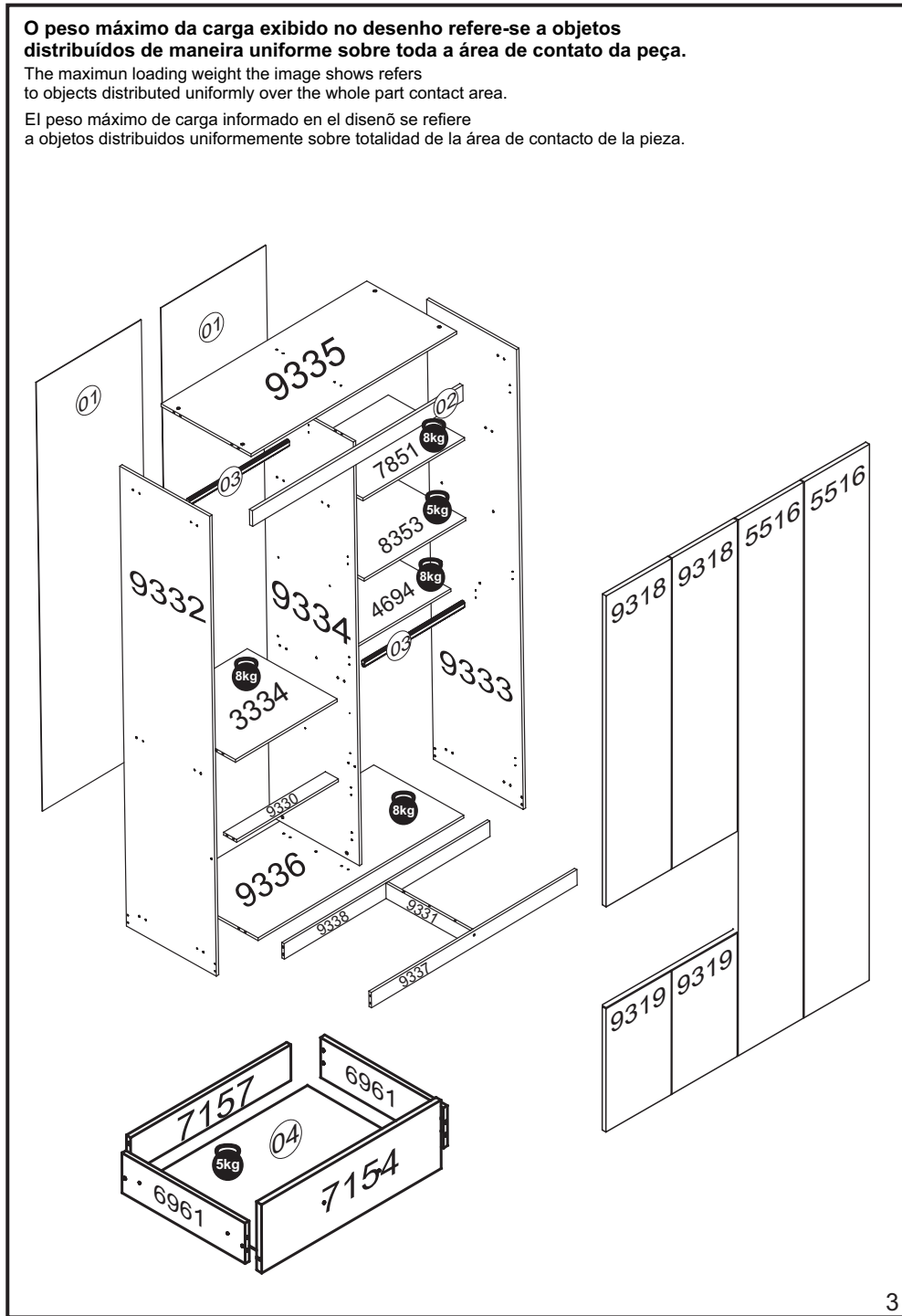
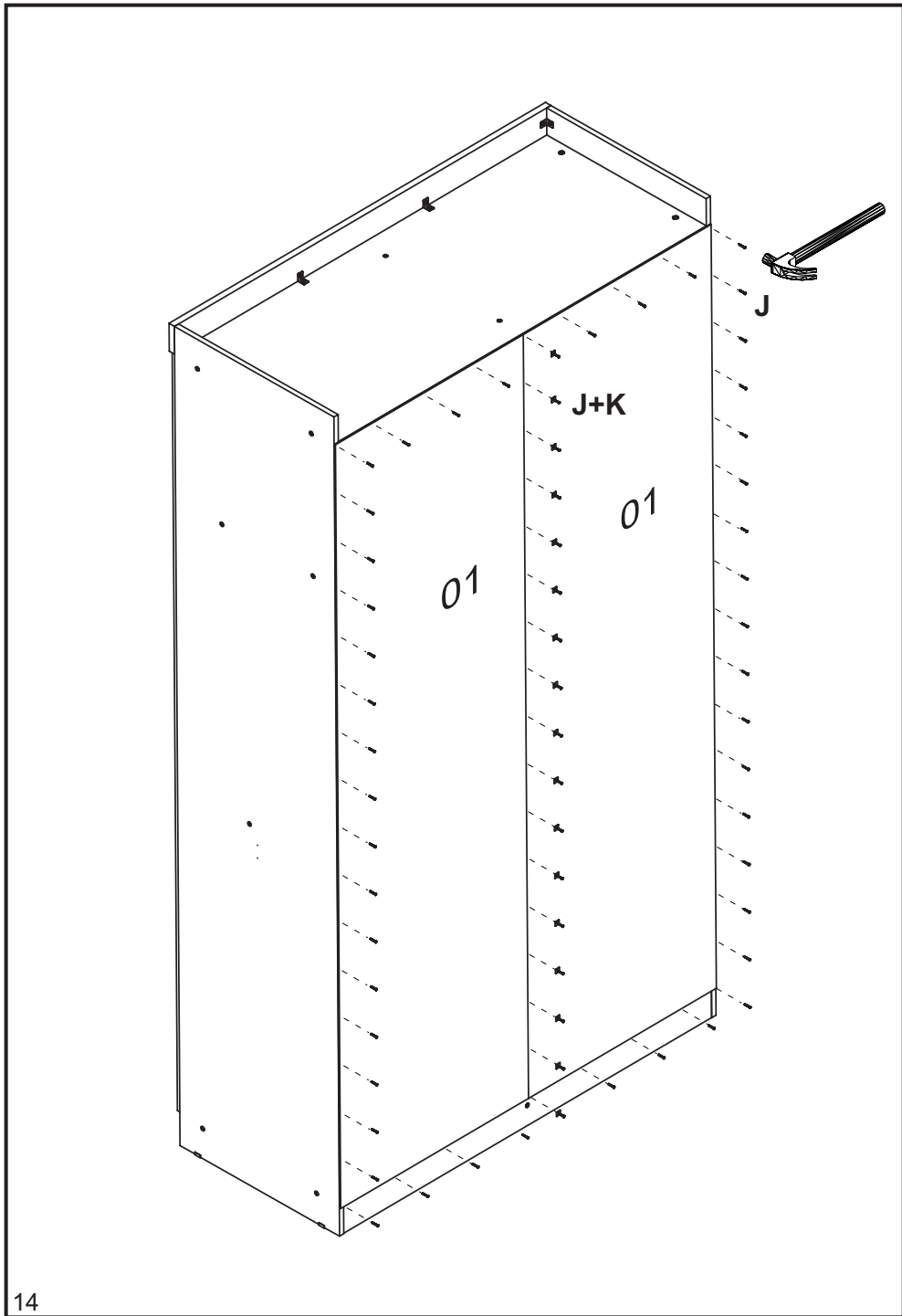





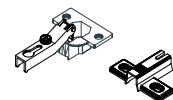



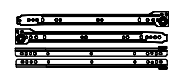

*Attach the mirrors to the door and wait about 01 hour to place it on the product.*

*Coloque los espejos en la puerta y espere alrededor 01 hora para colocarlos sobre el producto.*

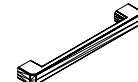
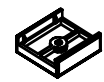

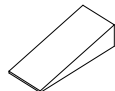

**RELAÇÃO DE ACESSÓRIOS**  
LIST OF ACCESSORIES • LISTA DE ACCESORIOS

<p><b>A</b> 22</p>  <p><b>PARAFUSO FI CH PH 4,0x50</b> SCREW FI CH PH 4,0x50 TORNILLO FI CH PH 4,0x50</p>	<p><b>B</b> 16</p>  <p><b>PARAFUSO FI FL PH 3,5x30</b> SCREW FI FL PH 3,5x30 TORNILLO FI FL PH 3,5x30</p>	<p><b>C</b> 02</p>  <p><b>PORCA SX MA4</b> NUT SX MA4 TUERCA SX MA4</p>	<p><b>D</b> 16</p>  <p><b>DOBRA METAL 26mm C/ CALÇO</b> METAL HINGE 26mm WITH EDGE BISAGRA METAL 26mm CON CALZO</p>
<p><b>E</b> 68</p>  <p><b>PARAFUSO FI CH PH 4,0x12</b> SCREW FI CH PH 4,0x12 TORNILLO FI CH PH 4,0x12</p>	<p><b>F</b> 50</p>  <p><b>CAVILHA MADEIRA 6x25</b> WOOD PEG 6x25 TARUGO DE MADEIRA 6x25</p>	<p><b>G</b> 22</p>  <p><b>PORCA CILINDRICA 12x09</b> CYLINDRICAL NUT 12x09 TUERCA CILINDRICA 12x09</p>	<p><b>H</b> 08</p>  <p><b>CANTONEIRA METAL</b> BRACKET METAL CANTONEIRA METAL</p>
<p><b>I</b> 02</p>  <p><b>CONJ. CORREDIÇA METAL 350mm</b> SET OF METAL SLIDES 350mm CONJ. DE RIELES DE METAL 350mm</p>	<p><b>J</b> 90</p>  <p><b>PREGO 10x10</b> NAIL 10x10 CLAVO 10x10</p>	<p><b>K</b> 16</p>  <p><b>FIXADOR FUNDO</b> BACKBOARD'S FIXER FIJADOR DEL COSTADO</p>	<p><b>L</b> 04</p>  <p><b>SUPORTE CABIDEIRO OB.</b> HANGER HOLDER SOPORTE PARA PERCHERO</p>
<p><b>M</b> 07</p>  <p><b>PARAFUSO FI CH PH 3,5x40</b> SCREW FI CH PH 3,5x40 TORNILLO FI CH PH 3,5x40</p>	<p><b>N</b> 02</p>  <p><b>PINO GIROFIX 35mm</b> GIROFIX PIN 35mm TORNILLO DEL GIROFIX 35mm</p>	<p><b>O</b> 08</p>  <p><b>PUX. VERO 160mm</b> HANDLE VERO 160mm TIRADOR VERO 160mm</p>	<p><b>P</b> 06</p>  <p><b>SAPATA LAT. MINI 12mm</b> SHOE SIDE. MINI 12mm SAPATA LAT. MINI 12mm</p>
<p><b>Q</b> 01</p>  <p><b>COLA PVA</b> GLUE PVA COLA PVA</p>	<p><b>R</b> 32</p>  <p><b>PARAFUSO FI CH PH 4,0x14</b> SCREW FI CH PH 4,0x14 TORNILLO FI CH PH 4,0x14</p>	<p><b>S</b> 06</p>  <p><b>PREGO 12x12</b> NAIL 12x12 CLAVO 12x12</p>	<p><b>T</b> 02</p>  <p><b>PARAFUSO MQ PN PH 4,0x25</b> SCREW MQ PN PH 4,0x25 TORNILLO MQ PN PH 4,0x25</p>
<p><b>U</b> 02</p>  <p><b>CASTANHA GIROFIX 12x09</b> MINIFIX 12x09 MINIFIX 12x09</p>	<p><b>V</b> 04</p>  <p><b>CUNHA</b> WEDGE CUÑA</p>		

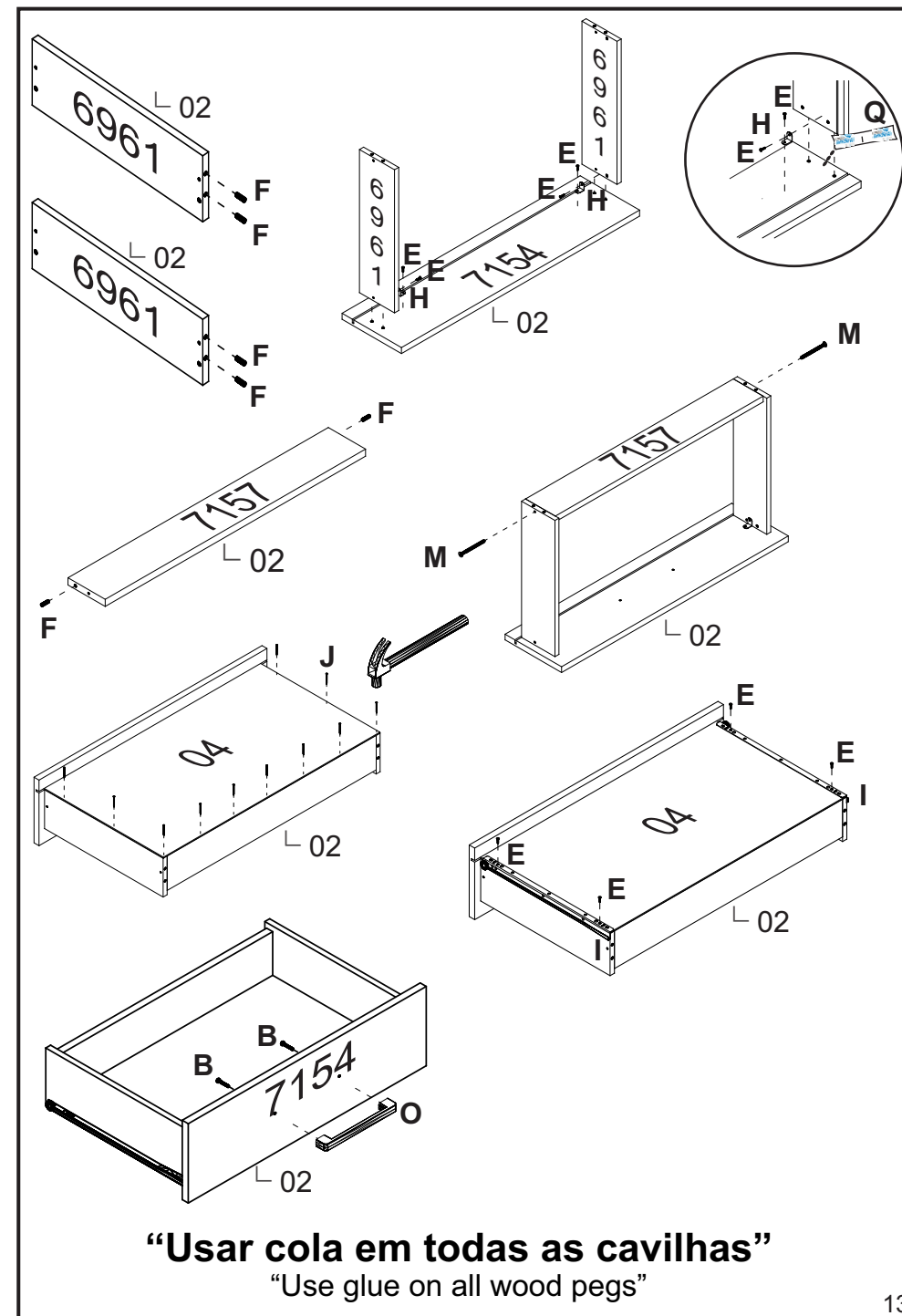

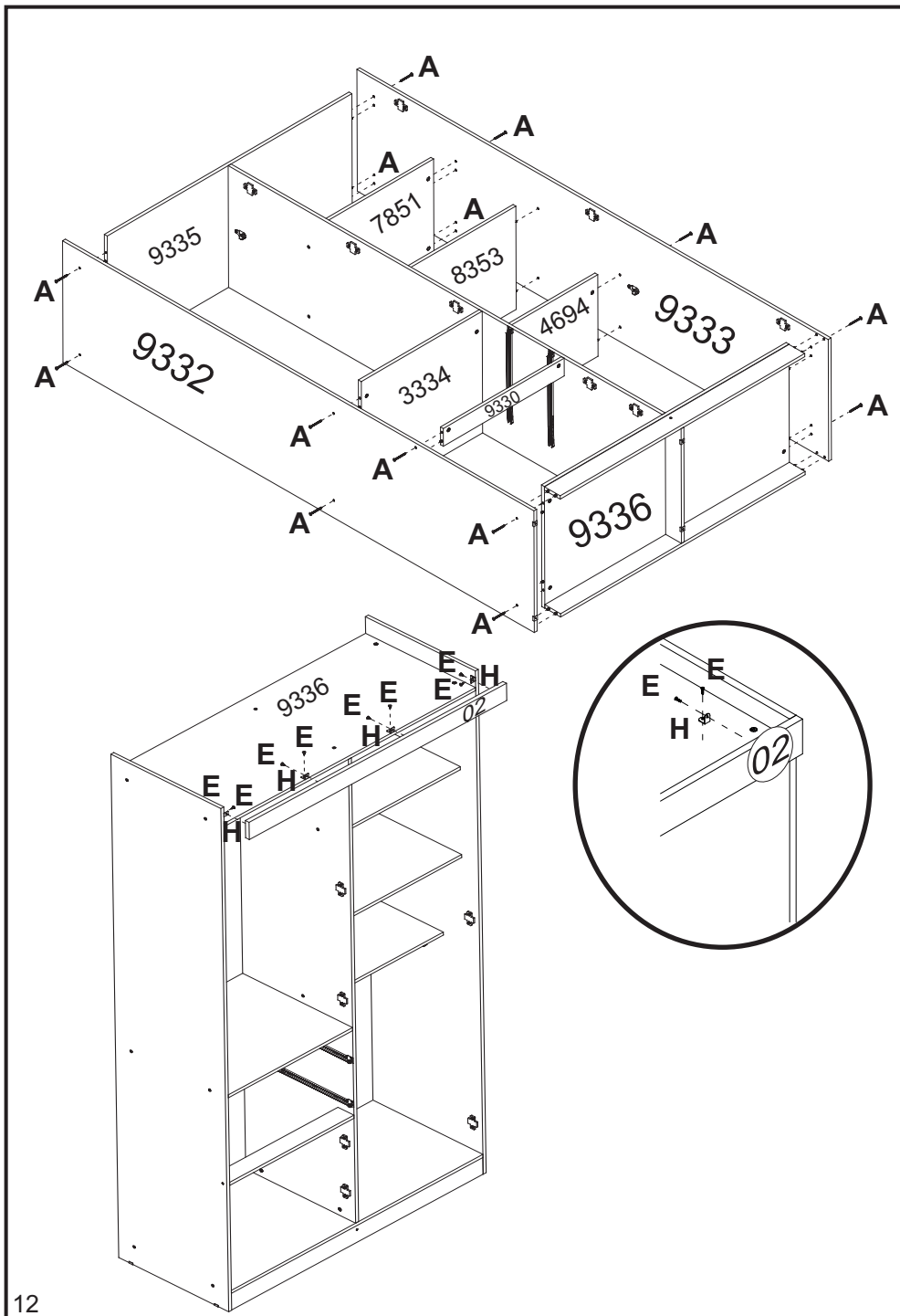

**RELAÇÃO DE PEÇAS**  
LIST OF PARTS • LISTA DE PARTES

DESCRIÇÃO DESCRIPTION DESCRIPCIÓN	VOLUME VOLUME VOLUMEM	NÚMERO NUMBER NÚMERO	DIMENSÃO DIMENSION DIMENSIÓN	QUANTIDADE QUANTITY CANTIDAD
<b>VISTA SUPERIOR</b> SUPERIOR FRONTAGE VISTA SUPERIOR	01	02	1066x068x15	01
<b>CABIDEIRO ECO. FRIZADO</b> FRIZZED ECO. HANGER PERCHERO ECO. FRIZADO	01	03	506mm	02
<b>FUNDO DE GAVETA</b> DRAWER'S BOTTOM FONDO DEL CAJÓN	01	04	448x365x2,5	02
<b>TAMPO</b> COVER TAPA	01	3334	515x448x12	01
<b>TAMPO</b> COVER TAPA	01	4694	515x300x12	01
<b>LAT. DE GAVETA</b> SIDE DRAWER LATERAL DE CAJÓN	01	6961	357x101x12	04
<b>TRASEIRO DE GAVETA</b> DRAWER'S BACKBOARD TRASERO DE CAJÓN	01	7157	466x090x12	02
<b>TAMPO</b> COVER TAPA	01	7851	515x380x12	01
<b>PRATELEIRA</b> SHELF ESTANTE	01	8353	515x380x12	01
<b>TRAVA</b> LOCK TRABA	01	9330	515x065x12	01
<b>RODAPE CALÇO</b> WEDGE BASEBOARD ZÓCALO CALZO	01	9331	422x067x12	01
<b>LAT. EXT. ESQUERDA</b> LEFT EXTERNAL SIDE LAT. EXT. IZQUIERDA	01	9332	2000x448x12	01
<b>LAT. EXT. DIREITA</b> RIGHT EXTERNAL SIDE LATERAL EXTERNA DERECHA	01	9333	2000x448x12	01
<b>LAT. INT. CENTRAL</b> INTERNAL SIDE LAT. INTERNA	01	9334	1843x448x12	01
<b>CHAPEU</b> WARDROBE'S TOP TAPA SUPERIOR	01	9335	1042x448x12	01
<b>BASE INF.</b> BOTTOM BASE BASE INFERIOR	01	9336	1042x448x12	01
<b>RODAPE FRONTAL</b> FRONT BASEBOARD ZÓCALO FRONTAL	01	9337	1042x067x12	01
<b>RODAPE TRASEIRO</b> BACK BASEBOARD ZÓCALO TRASERO	01	9338	1042x067x12	01
DESCRIÇÃO DESCRIPTION DESCRIPCIÓN	VOLUME VOLUME VOLUMEM	NÚMERO NUMBER NÚMERO	DIMENSÃO DIMENSION DIMENSIÓN	QUANTIDADE QUANTITY CANTIDAD
<b>TRASEIRO G.R</b> WARDROBE'S BACKBOARD COSTADO DEL ROPERO	02	01	1865x532x2,5	02

**Ps: Peças e Complementos que não contém processo de furação não são enumeradas.**  
**Parts and Accessories that do not contain drilling process and are not listed.**  
**Piezas y Accesorios que no contienen procesos de perforación y que no numerados.**

**RELAÇÃO DE PEÇAS**  
LIST OF PARTS • LISTA DE PARTES

DESCRIÇÃO DESCRIPTION DESCRIPCIÓN	VOLUME VOLUME VOLUMEM	NÚMERO NUMBER NUMERO	DIMENSÃO DIMENSION DIMENSIÓN	QUANTIDADE QUANTITY CANTIDAD
<b>PORTA</b> DOOR PUERTA	02	5516	1852x260x15	02
<b>FRENTE DE GAVETA</b> DRAWER'S FRONT FRENTE DEL CAJÓN	02	7154	523x170x15	02
<b>PORTA</b> DOOR PUERTA	02	9318	1074x260x15	02
<b>PORTA</b> DOOR PUERTA	02	9319	426x260x15	02

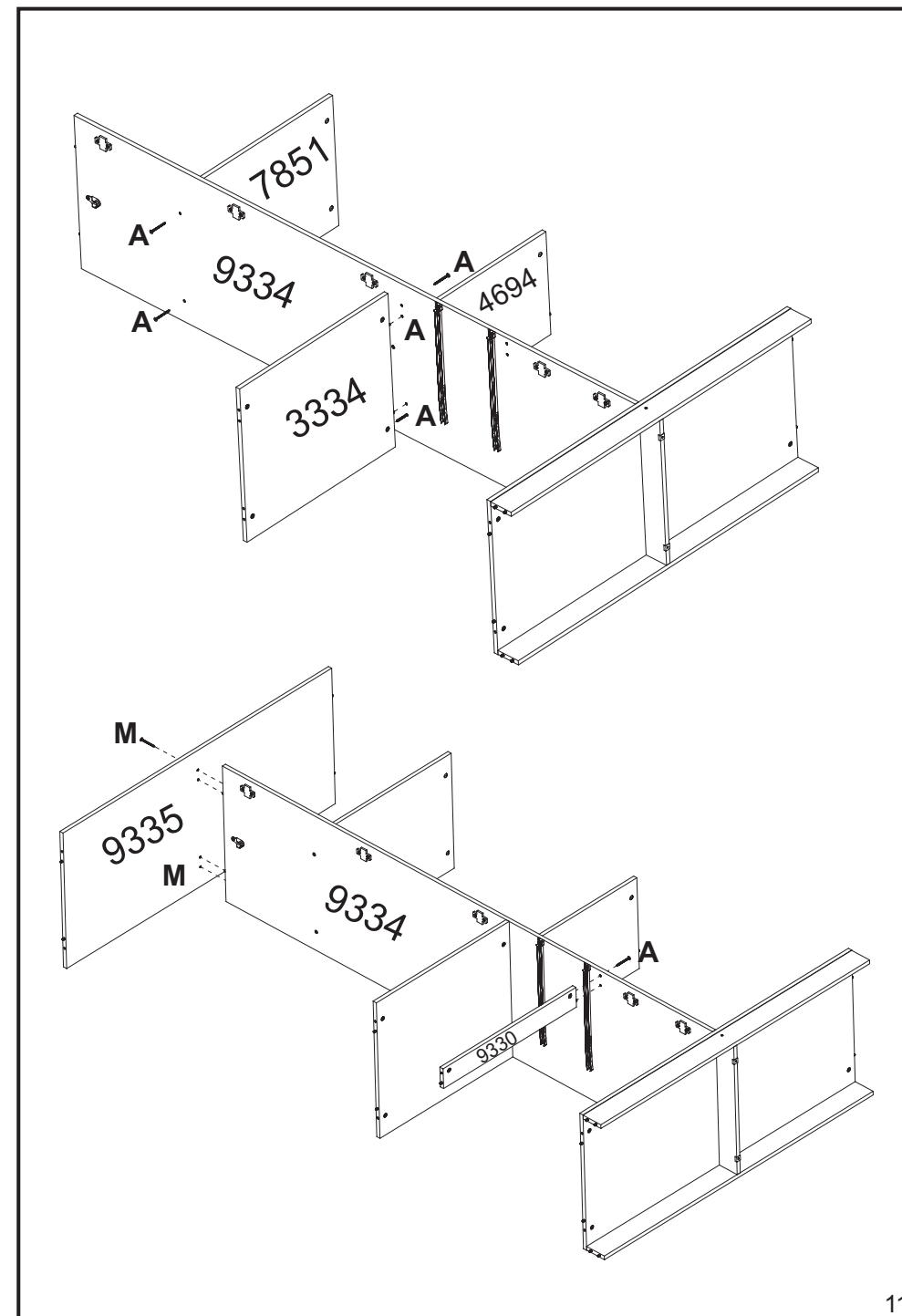

Ps: Peças e Complementos que não contém processo de furação não são enumeradas.  
Parts and Accessories that do not contain drilling process and are not listed.  
Piezas y Accesorios que no contienen procesos de perforación y que no numerados.

