

# E-963

# Manual de Montagem

Assembly Manual / Manual Asamblea

Rev.: 01

Data: 26/03/2024

Cód.: 1524

## Cristaleira Vitrina Hutch

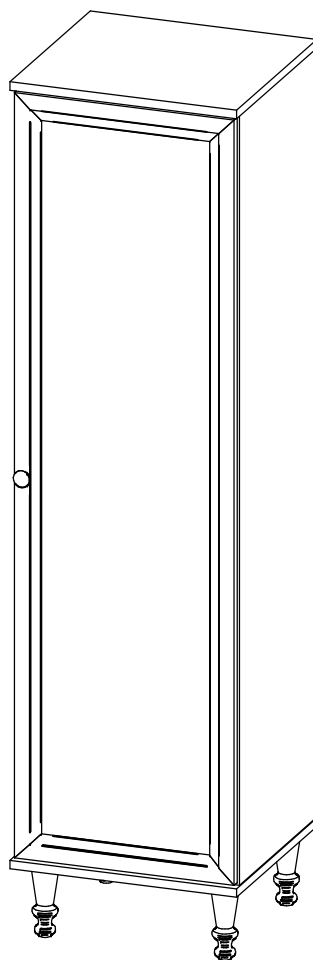

### Notas especiais:

- 01 - Examine completamente todas as peças do móvel antes de iniciar o trabalho.
- 02 - Recomenda-se montar o móvel conforme este manual de montagem, em caso de dúvida contate a empresa.
- 03 - É de responsabilidade do montador seguir as instruções do Manual de Montagem, que são fundamentais para garantir a estrutura do móvel.

### Special Notes:

- 01 - Examine carefully all parts of the furniture before starting the work.
- 02 - It is recommended to assemble the furniture as this assembly manual, if in doubt contact the company.
- 03 - The assembler has the responsibility of following the instructions of the Assembly Manual, which are essential to insure the furniture structure.

### Notas Especiales:

- 01 - Examinar a fondo todas las piezas de los muebles antes de comenzar el trabajo.
- 02 - Se recomienda montar el mueble como este manual de montaje, en caso de duda póngase en contacto con la empresa
- 03 - Es responsabilidad del instalador de seguir las instrucciones del Manual de la Asamblea, que son esenciales para asegurar la estructura del móvil.

**Aviso:** Para mais informações consulte o site da empresa, através do link: [www.ditalia.com.br](http://www.ditalia.com.br)  
For more information see the company's website at the following link: [www.ditalia.com.br](http://www.ditalia.com.br)  
Para obtener más información, consulte el sitio web de la compañía en el siguiente enlace: [www.ditalia.com.br](http://www.ditalia.com.br)

**Antes de montar seu móvel, leia cuidadosamente o Manual de Instruções e o mantenha para futuras consultas. OBRIGADO. Before assembling your furniture, read the Assembly Instructions carefully, and keep it for future checking. THANKS!**

**Antes de armar su mueble, lea el Manual de Instrucciones cuidadosamente y consérvelo para futuras referencias. GRACIAS**

Ditalia Móveis Industrial Ltda • Estrada RS-444, s/n • KM-26 • Prédio Adm. • Monte Belo do Sul • RS • Brasil

• CEP-95718-000 • Fone/Fax (55.54) 2102.5000 • e-mail: [assistencia@ditalia.com.br](mailto:assistencia@ditalia.com.br) • [www.ditalia.com.br](http://www.ditalia.com.br)













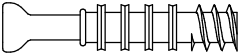

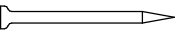

**Limpeza:** utilizar apenas pano umedecido com água.

**Cleaning:** use only a cloth moistened with water.

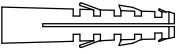
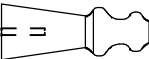
**Limpieza:** use sólo un paño humedecido en agua.

**LISTA DE FERRAGENS / HARDWARE LIST / LISTA DE MATERIALES**

COD	DESCRIÇÃO / DESCRIPTION / DESCRIPCIÓN	QTD
<b>A</b>	 Cavilha Ø6x30 Wood Dowel / Clavija	<b>20</b>
<b>AZ</b>	 Chave 21x47x4 Key 21x47x4 / Clave 21x47x4	<b>1</b>
<b>B</b>	 Parafuso Minifix Cam Bolt / Tornillo minifix	<b>10</b>
<b>C</b>	 Tambor Minifix Cam Lock / Tambor Minifix	<b>10</b>
<b>D</b>	 Parafuso CC 3,5x14 Screw / Tornillo	<b>14</b>
<b>DB</b>	 Dobradiça Baixa Hinge / Bisagra	<b>3</b>
<b>DZ</b>	 Parafuso CC 7x50 Screw / Tornillo	<b>4</b>
<b>E</b>	 Parafuso CC 4x40 Screw / Tornillo	<b>1</b>
<b>EN</b>	 Prego 10x10 Nail / Clavo	<b>40</b>
<b>FB</b>	 Parafuso M4x22 Screw / Tornillo	<b>1</b>
<b>FM</b>	 Tampa para parafuso Allen Plastic Cap / Tapa p/ Tornillo	<b>4</b>
<b>L</b>	 Bucha Plástica 6mm Plug / Tapón	<b>1</b>
<b>PE</b>	 Pé Madeira Foot / Pie	<b>4</b>
<b>PX</b>	 Puxador Ø 29,5 Handle / Tirador	<b>1</b>
<b>V</b>	 04.08.032 Cantoneira Metallic bracket / Soporte de metal	<b>1</b>
<b>Y</b>	 Adesivo Tapa Furo Sticker / Adhesivo	<b>8</b>

**LISTA DE PEÇAS/PIECES LIST/LISTA DE PIEZAS**

Nº	COD __ DESCRIÇÃO/DESCRIPTION/DESCRIPCIÓN	DIMENSÃO/DIM	QTD
01	103303 Tampo / Top / Tapa	400 x 376 x 15	1
02	102333 Lateral / Side / Lateral	1350 x 358 x 15	2
03	103304 Prateleira Menor / Shelf / Estante	367 x 298 x 15	1
04	103305 Costa / Back / Costa	390 x 1372 x 3	1
06	103302 Base / Base / Base	400 x 376 x 15	1
07	102341 Porta Moldura / Door / Puerta	1342 x 388 x 15	1
08	103306 Prateleira Maior / Shelf / Estante	367 x 358 x 15	2

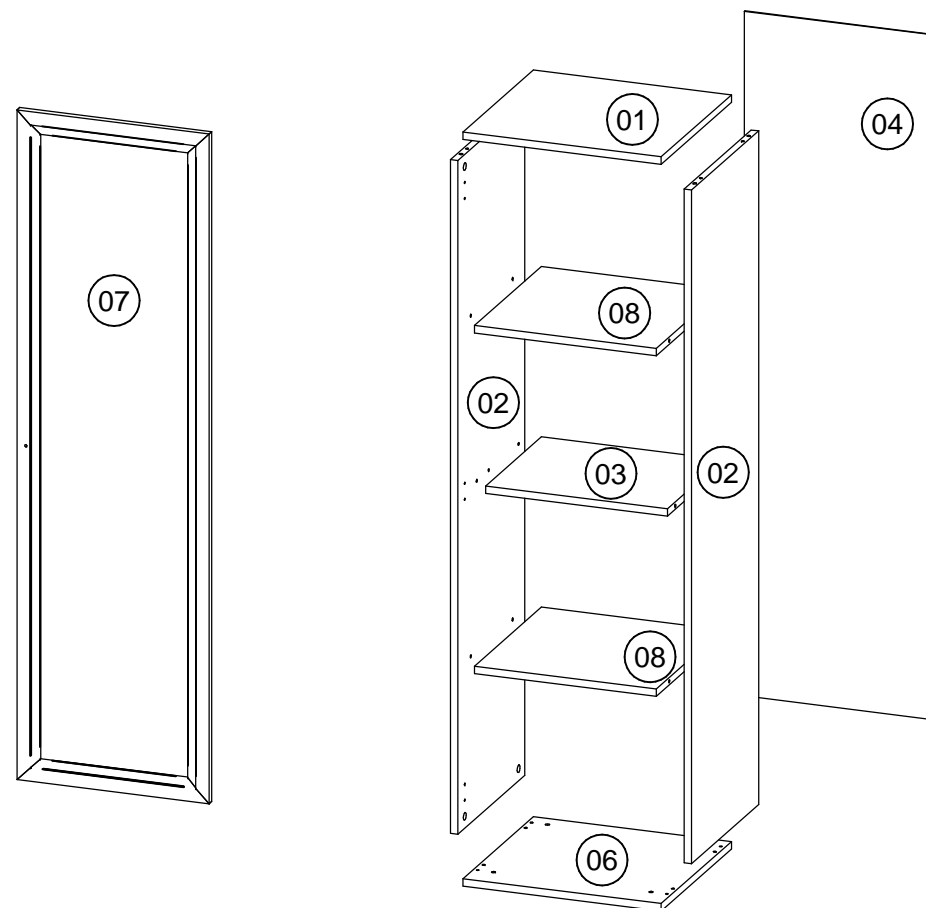

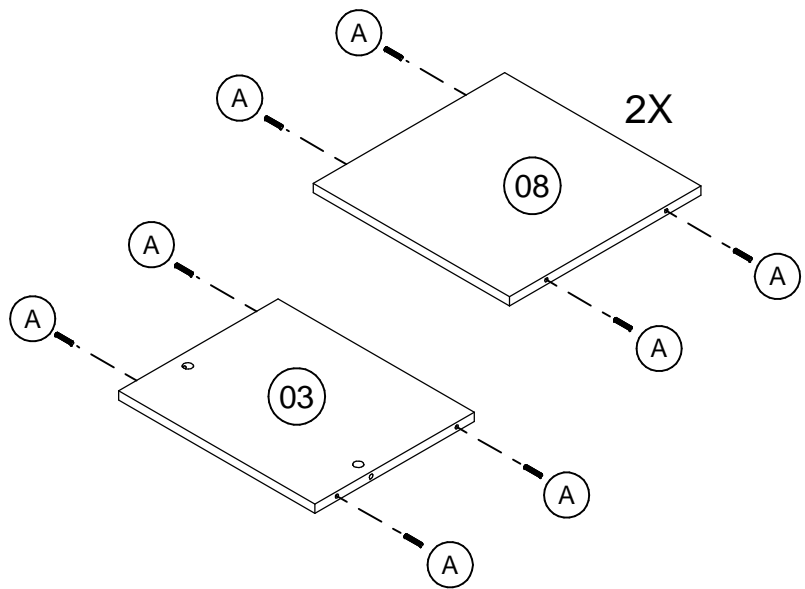
**01**

A		12
---	---	----

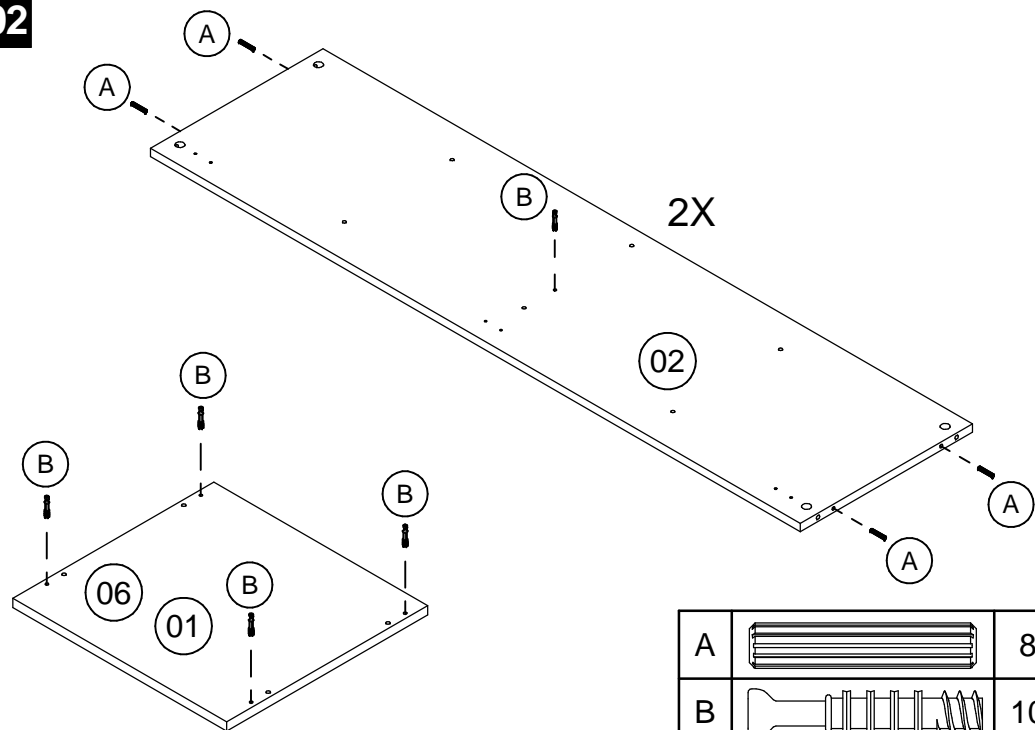
**02**

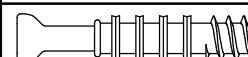
A		8
B		10

**03**

Obs: Fixar parafusos nos pés utilizando chave "AZ"

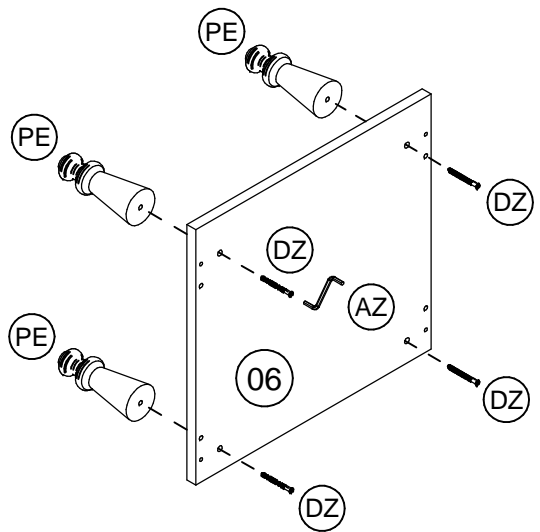
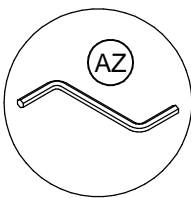

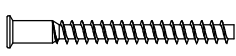
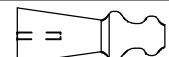
AZ		1
DZ		4
PE		4

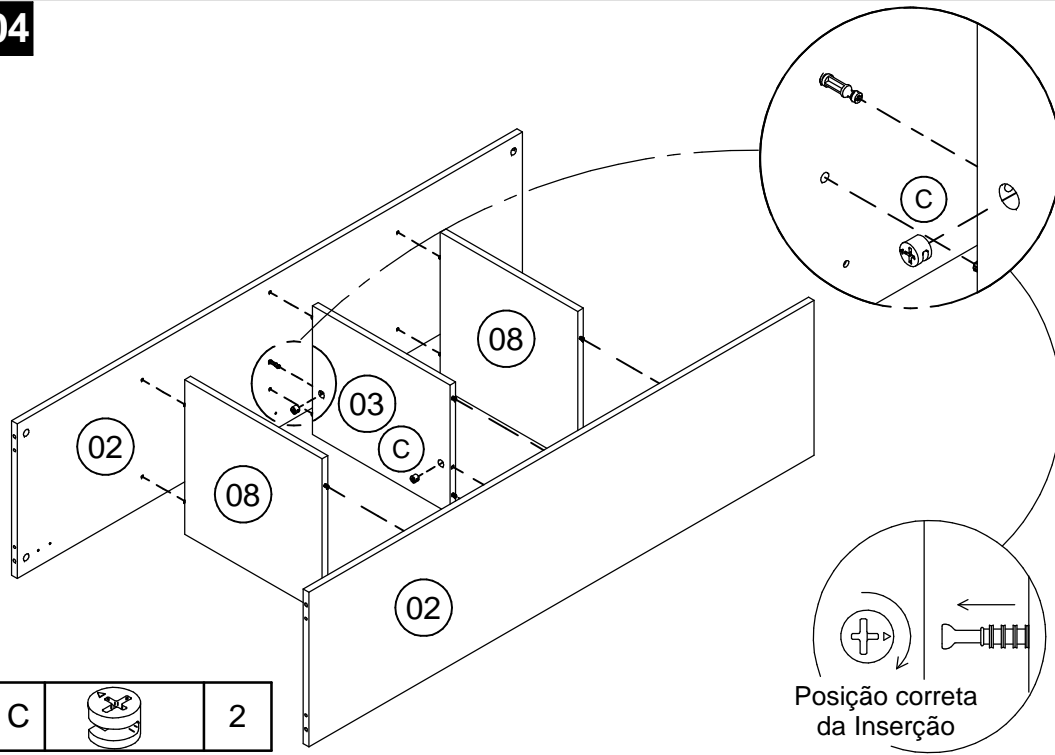
**04**

C		2
---	---	---

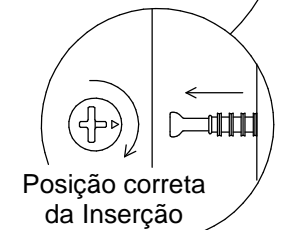

05

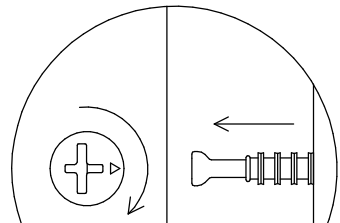

Posição correta da Inserção

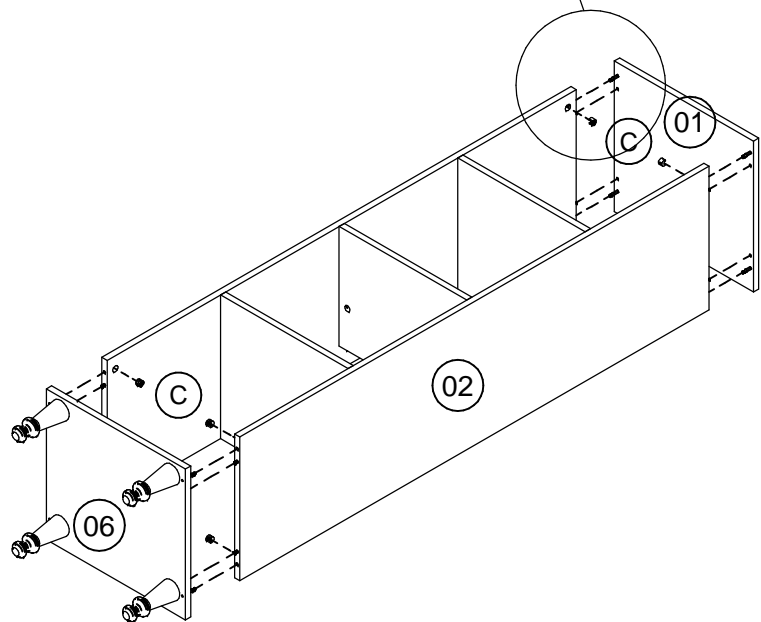

C		8
---	--	---

06

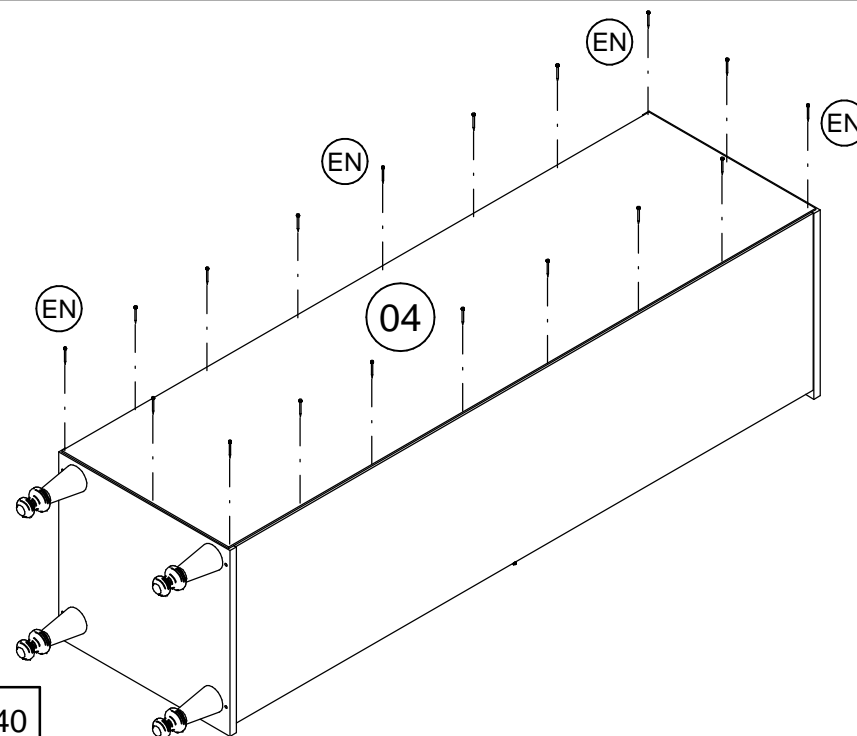

EN		40
----	--	----

07

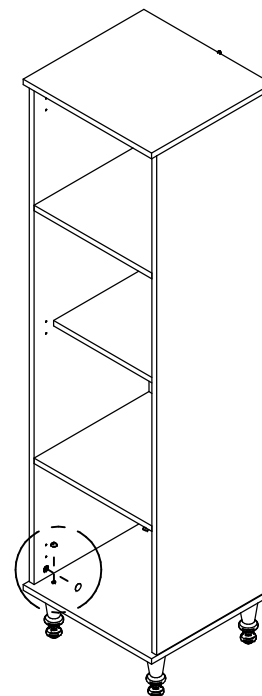
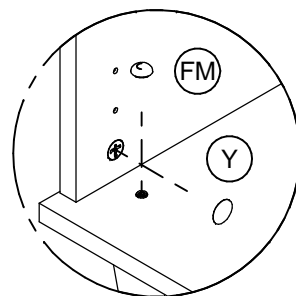

FM		4
Y		8

08

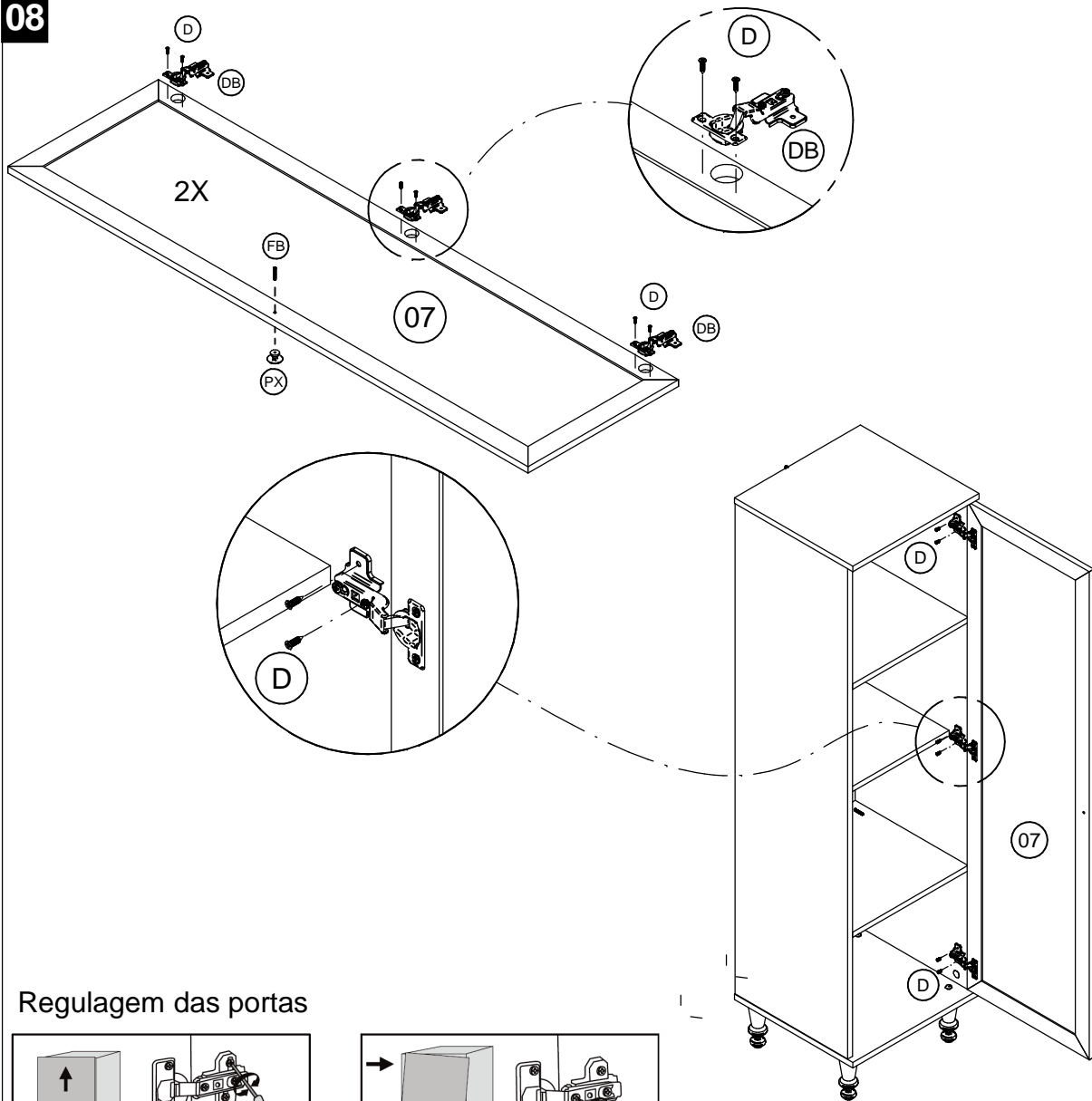

Regulagem das portas

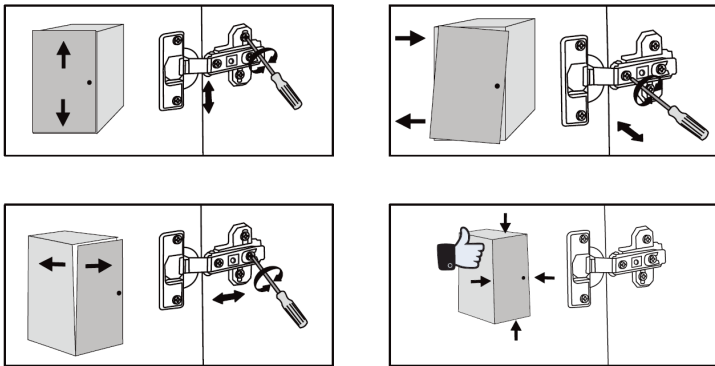

D		12
DB		3
FB		1
PX		1

09

Anti tombamento:  
Fixar cantoneira "V" na parte interna do móvel.  
Furar a parede e inserir bucha "L", após fixar com parafuso "E".

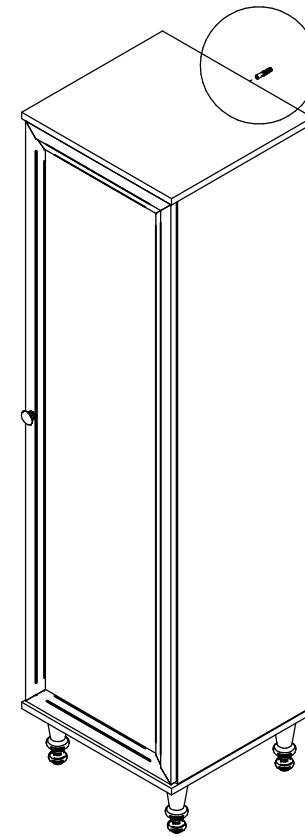
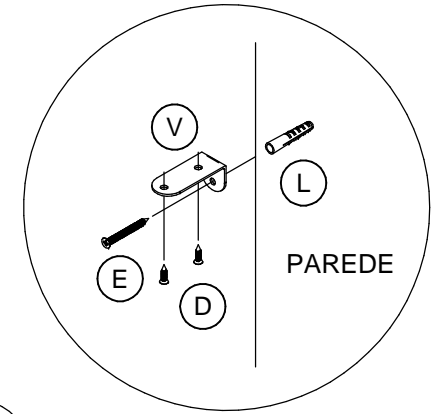

D		2
E		1
L		1
V		1