

CÔMODA IPANEMA 6GV - 1,50M
DRESSER IPANEMA 6GV - 1,50M
CÓMODA IPANEMA 6GV - 1,50M

FKEX-804 - VOL. 02

01/03/23 Rev. 05

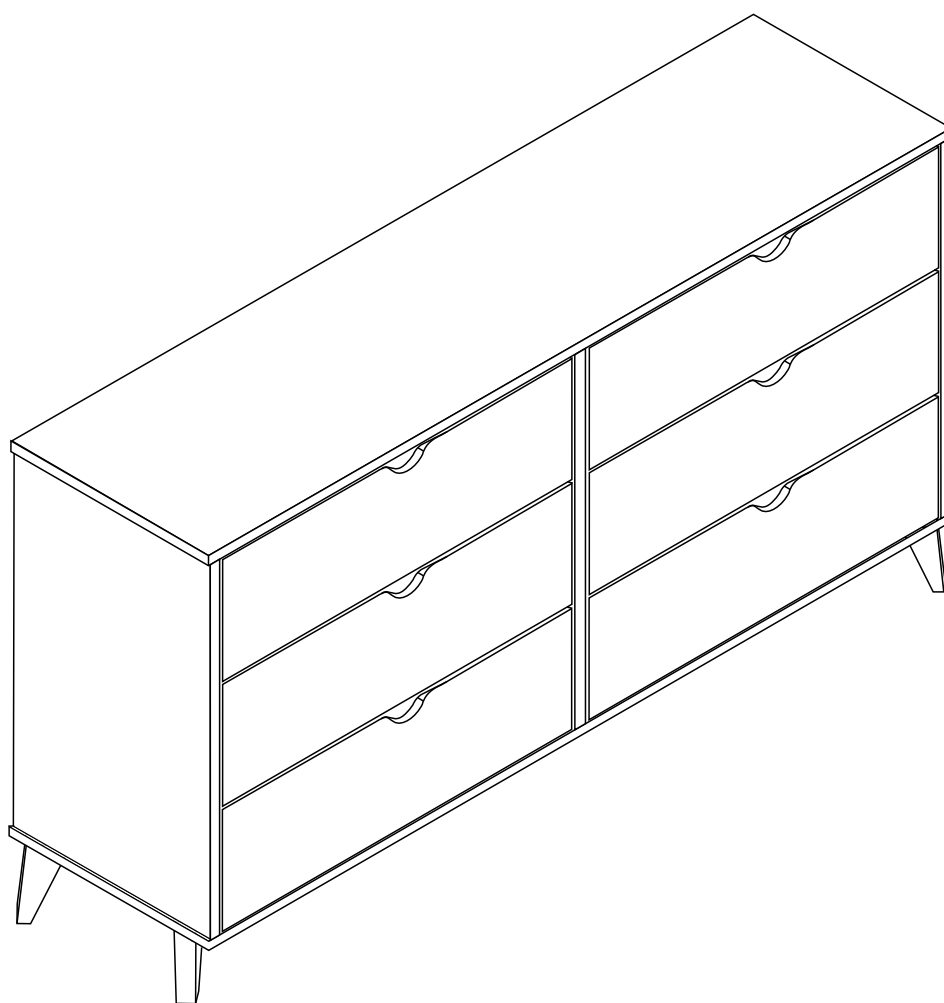

falkk



- **Antes de iniciar a montagem, verifique se você recebeu todos os componentes e peças do produto.**
- Before starting assembly, make sure you have received all the components and parts for the product.
- Antes de comenzar el montaje, asegúrese de haber recibido todos los componentes y piezas del producto.
- **Para montagem, sugerimos contratação de um profissional.**
- For assembly, we suggest hiring a professional.
- Para el montaje, sugerimos contratar a un profesional.

INSTRUÇÕES DE MONTAGEM ASSEMBLY INSTRUCTIONS INSTRUCCIONES DE MONTAJE



Pessoas necessárias.
Necessary people.
Gente necesaria.



Grau de dificuldade - alto.
Difficult level - high.
Nível de dificultad - alto.



Evitar batidas e objetos cortantes.
Avoid bumps and sharp objects.
Evitar golpes y objetos afilados.



Pano levemente umedecido com água, seguido de pano seco.
Cloth slightly dampened with water, followed by a dry cloth.
Paño ligeramente humedecido con agua, seguido de un paño seco.

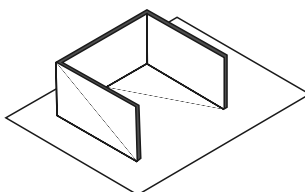

Deve-se fazer a montagem do módulo em cima de uma superfície macia. **Dica:** Usar a caixa.
The module must be mounted on a soft surface.
Tip: Use the box.
El módulo debe montarse sobre una superficie blanda. **Consejo:** Usa la caja.



Não utilizar químicos ou abrasivos na limpeza.
Do not use chemicals or abrasives for cleaning.
No utilice productos químicos o abrasivos

Ferramentas Necessárias required tools / herramientas requeridas (não fornecidas / not provided / no provisto)



Fita métrica
Measuring tape
Cinta métrica



Chave Philips
Philips Screwdriver
Destornillador Philips



Martelo
Hammer
Martillo



Furadeira
Power Drill
Taladro



ø 6mm e 10mm
ø 6mm and 10mm
ø 6mm y 10mm

Componentes do Módulo

Module Components

Componentes del Módulo

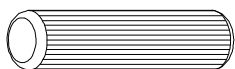

A - Cavilha 8x30 (12x)
 A - Peg 8x30 (12x)
 A - Espiga 8x30 (12x)

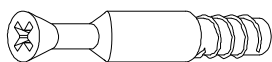

B - Minifix (6x)
 B - Minifix (6x)
 B - Minifix (6x)

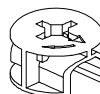

C - Tambor (6x)
 C - Drum (6x)
 C - Tambor (6x)

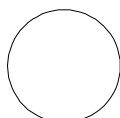

D - Tapa Furo Adesivo (6x)
 D - Self Adhesive Cap Cover (6x)
 D - Tapa Aguejo Autoadhesivos (6x)



F11 - Parafuso Euro Ø6x10 (24x)
 F11 - Screw Euro Ø6x10 (24x)
 F11 - Tornilo Euro Ø6x10 (24x)

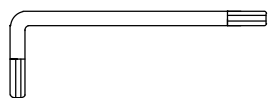

R1 - Chave Allen (1x)
 R1 - Key Allen (1x)
 R1 - Llave Allen (1x)



F4 - Parafuso Travessa Ø4x25 (8x)
 F4 - Screw Platter Ø4x25 (8x)
 F4 - Tornilo Plato Ø4x25 (8x)



F9 - Parafuso Euro Ø5x35 (4x)
 F9 - Screw Euro Ø5x35 (4x)
 F9 - Tornilo Euro Ø5x35 (4x)



F6 - Parafuso Pé Ø4x40 (8x)
 F6 - Screw Foot Ø4x40 (8x)
 F6 - Tornilo Pie Ø4x40 (8x)

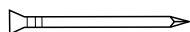

E - Prego 10x10 (30x)
 E - Nail 10x10 (30x)
 E - Clavo 10x10 (30x)

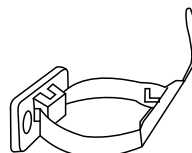

Z - Kit Anti Tombamento (2x)
 Z - Kit Anti tipping (2x)
 Z - Kit Antivuelco (2x)

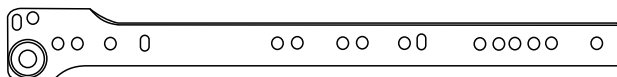

I2 - Corrediça Módulo (12x)
 I2 - Module Slide (12x)
 I2 - Corrediza Módulo (12x)

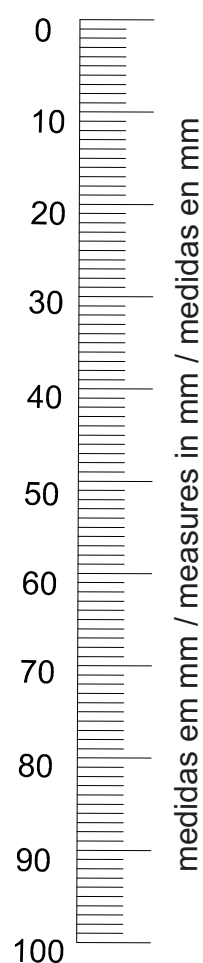

Partes do módulo

Module Parts

Partes del módulo

1 Base Superior (1x)
Top Base (1x) / Base Superior (1x)

2 Base Inferior (1x)
Bottom Base (1x) / Base Inferior (1x)

3 Lateral Direita (1x)
Right Side (1x) / Lado Derecho (1x)

4 Lateral Esquerda (1x)
Left Side (1x) / Lado Izquierdo (1x)

5 Costa (2x)
Coast (2x) / Costa (2x)

9 Divisória (1x)
Partition (1x) / Dividir (1x)

100 Pés (5x)
Foot (5x) / Pies (5x)

101 Travessas (3x)
Traviesas (3x) / Sleepers (3x)

103 Conector de Fundo (2x)
Bottom Connector (2x) / Conector Inferior (2x)

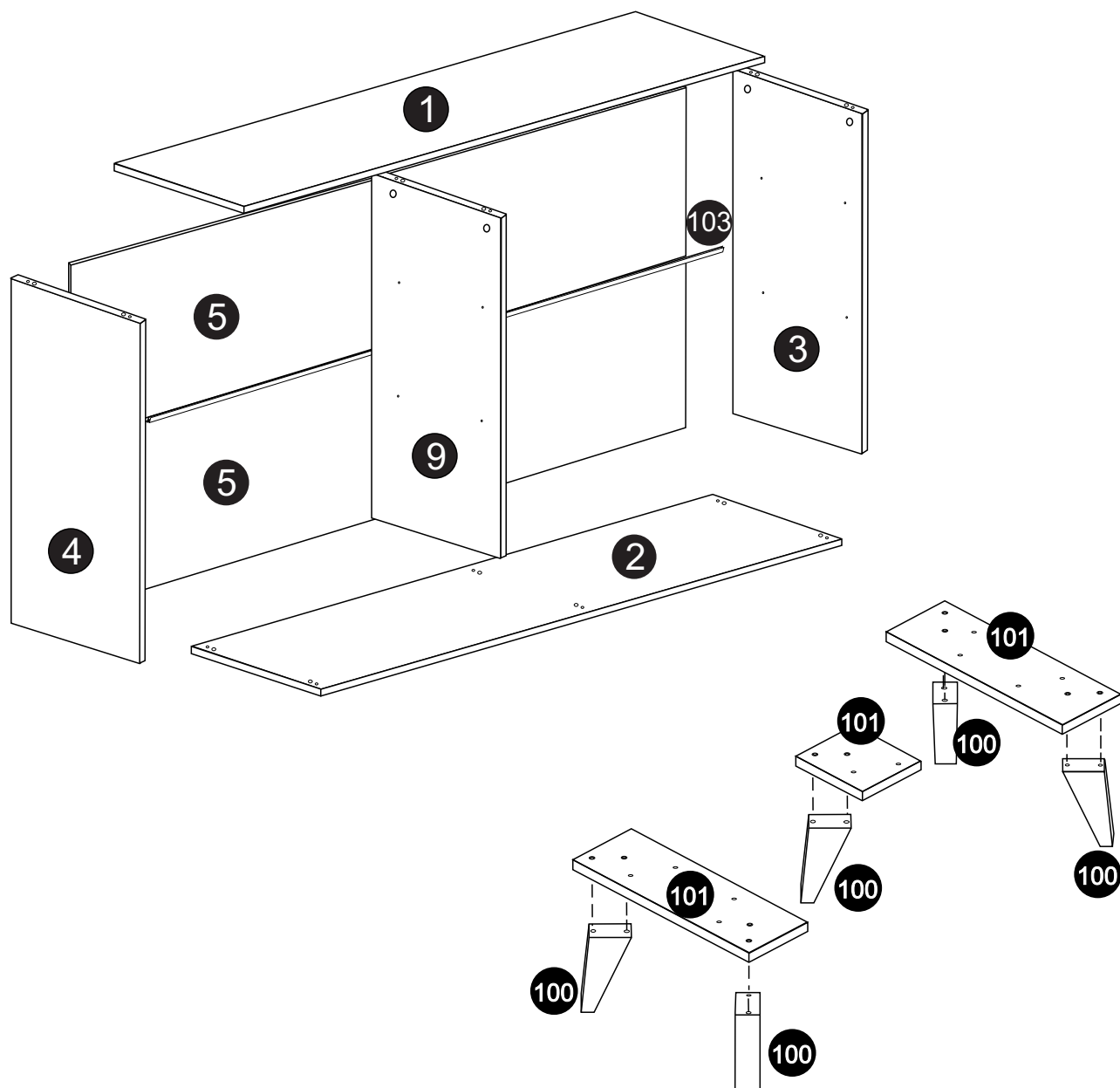

Pré montagem do módulo

Module pre-assembly

Premontaje del módulo

03

Lateral Direita
Right Side
Lado Deretcho

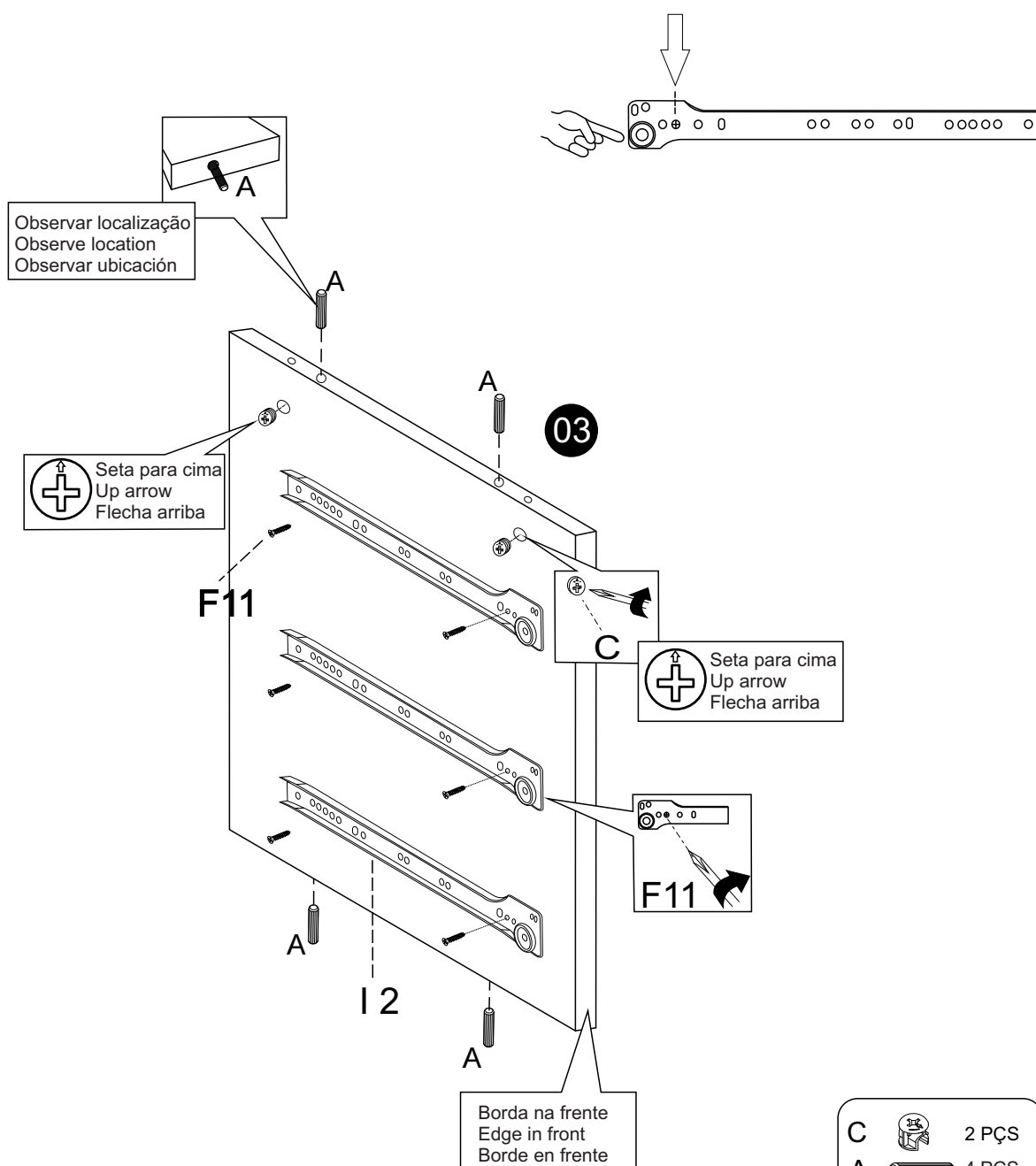

C		2 PÇS
A		4 PÇS
I 2		3 PÇS
F11		6 PÇS

04

Base Superior
Top Base
Base Superior

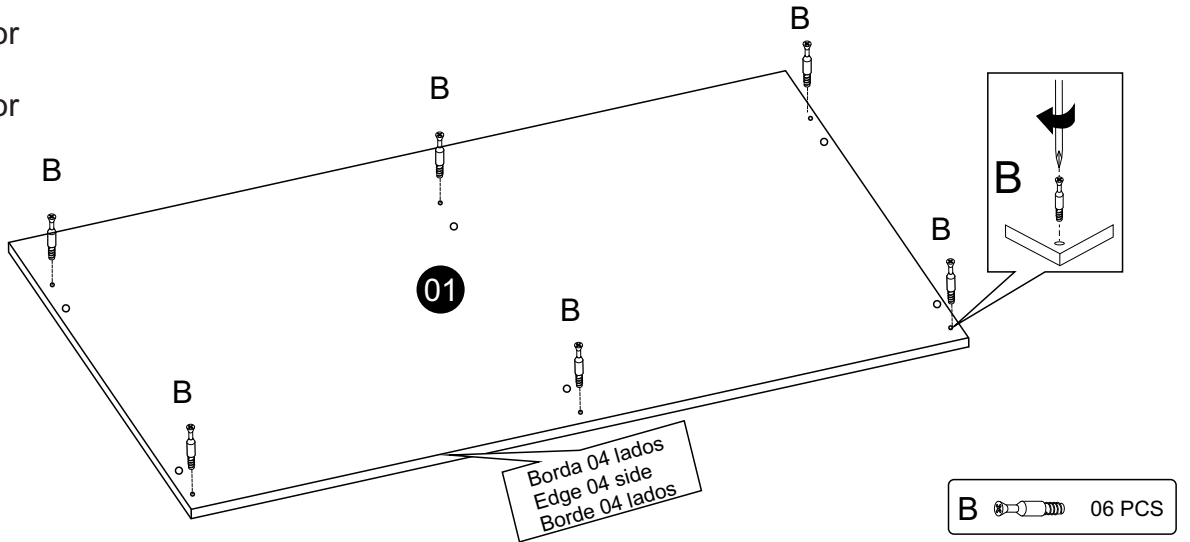

05

Base Inferior - Conferencia do desenho
Botton Base - Drawing conference
Base Inferior - Conferencia de dibujo

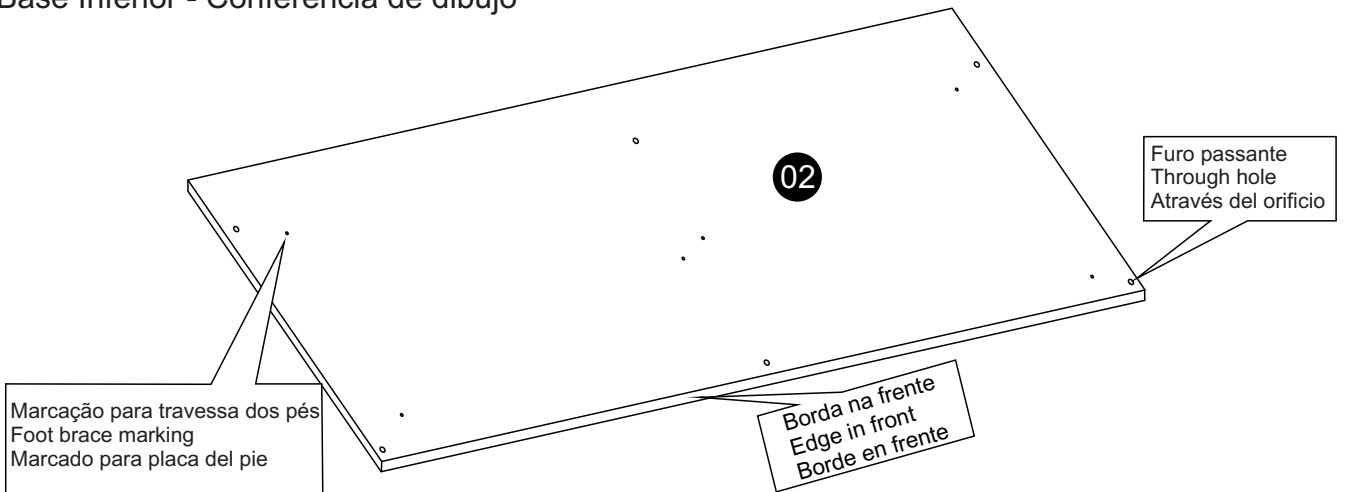

06

Costa
Coast
Costa

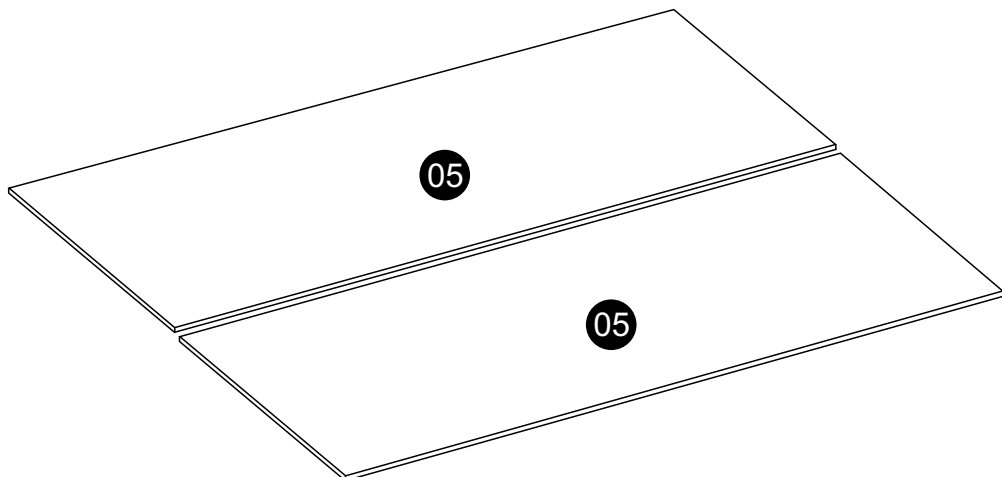

Montagem do módulo

Module assembly

Montaje del módulo

01

Base Superior + Lat. Esquerda

Top Base + Left Side

Base Superior + Lado Izquierdo

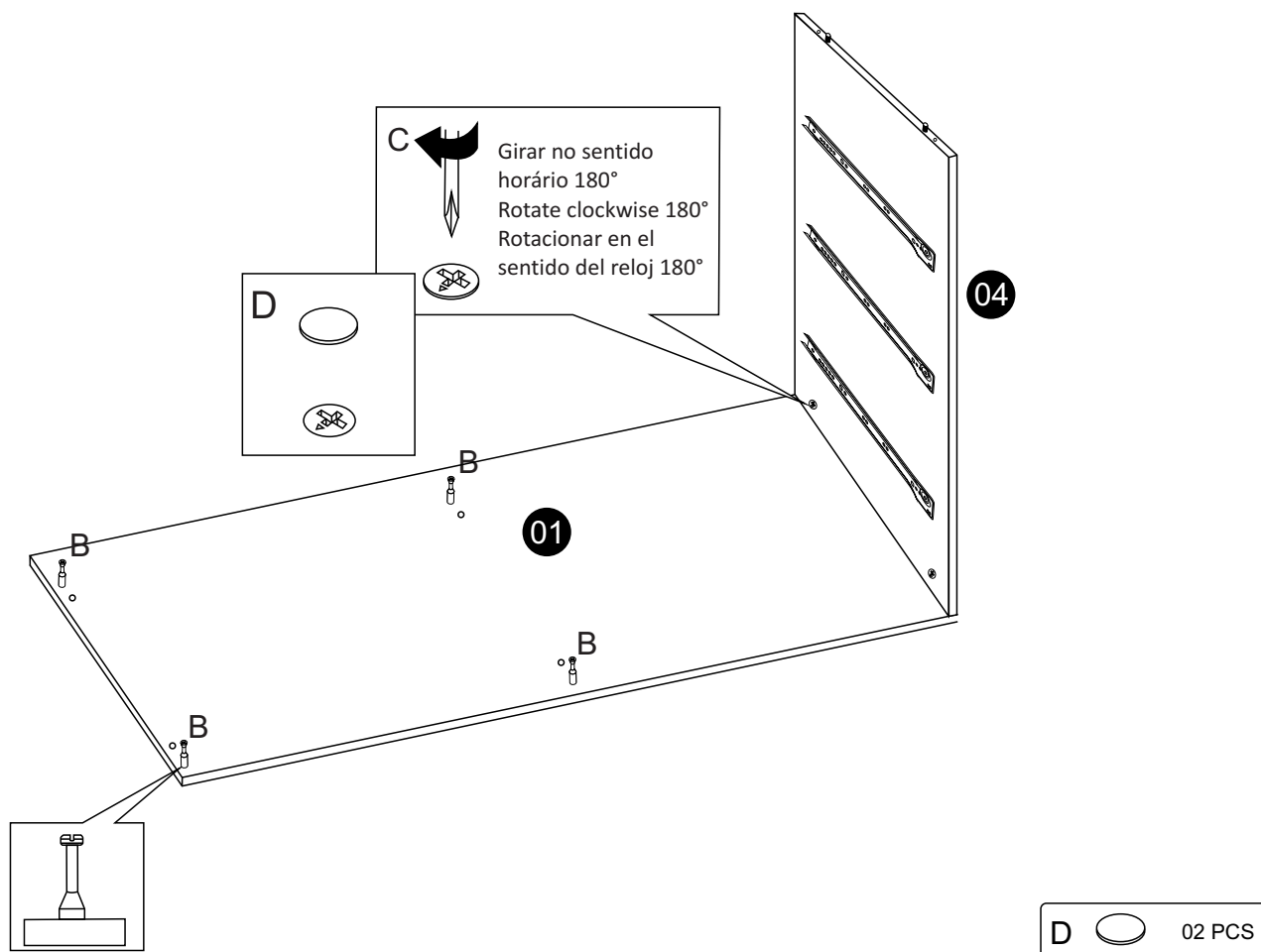

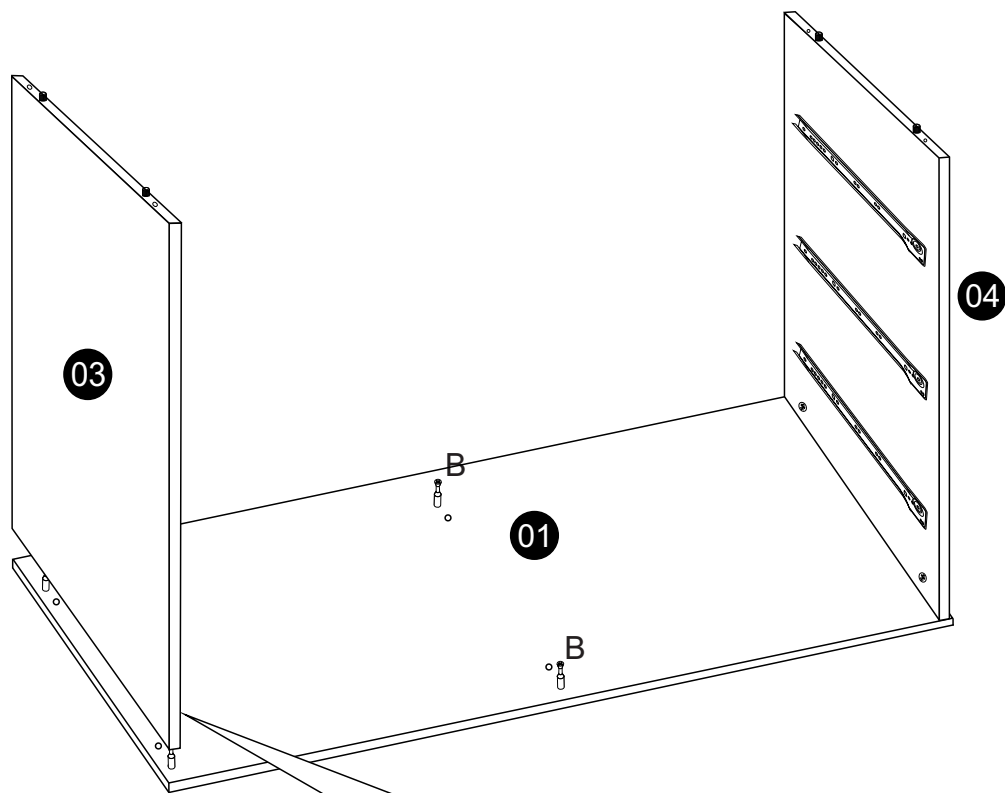

02

Base Superior + Lat. Esquerda + Lat. Direita
Top Base + Left Side + Right Side
Base Superior + Lado Izquierdo + Lado Derecho



C  Girar no sentido
horário 180°
Rotate clockwise 180°
Rotacionar en el
sentido del reloj 180°

D 



D  02 PCS

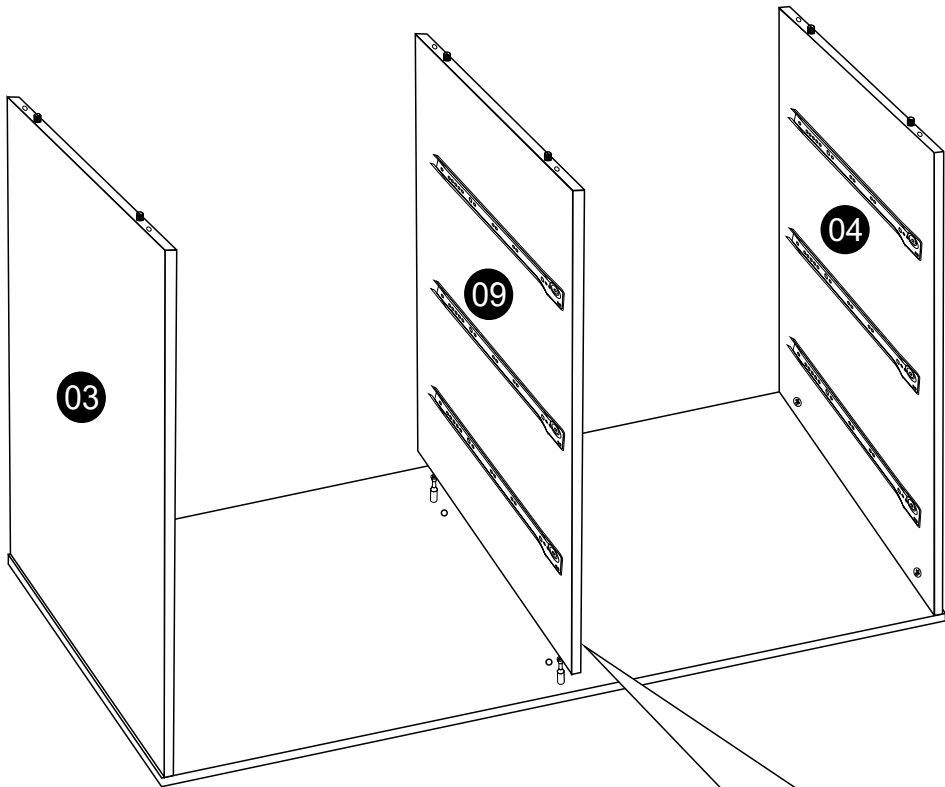

03

Base Superior + Lat. Esquerda + Lat. Direita + Divisória
Top Base + Left Side + Right Side + Partition
Base Superior + Lado Izquierdo + Lado Derecho + Dividir



C  Girar no sentido
horário 180°
Rotate clockwise 180°
Rotacionar en el
sentido del reloj 180°





D 

D  02 PCS

05

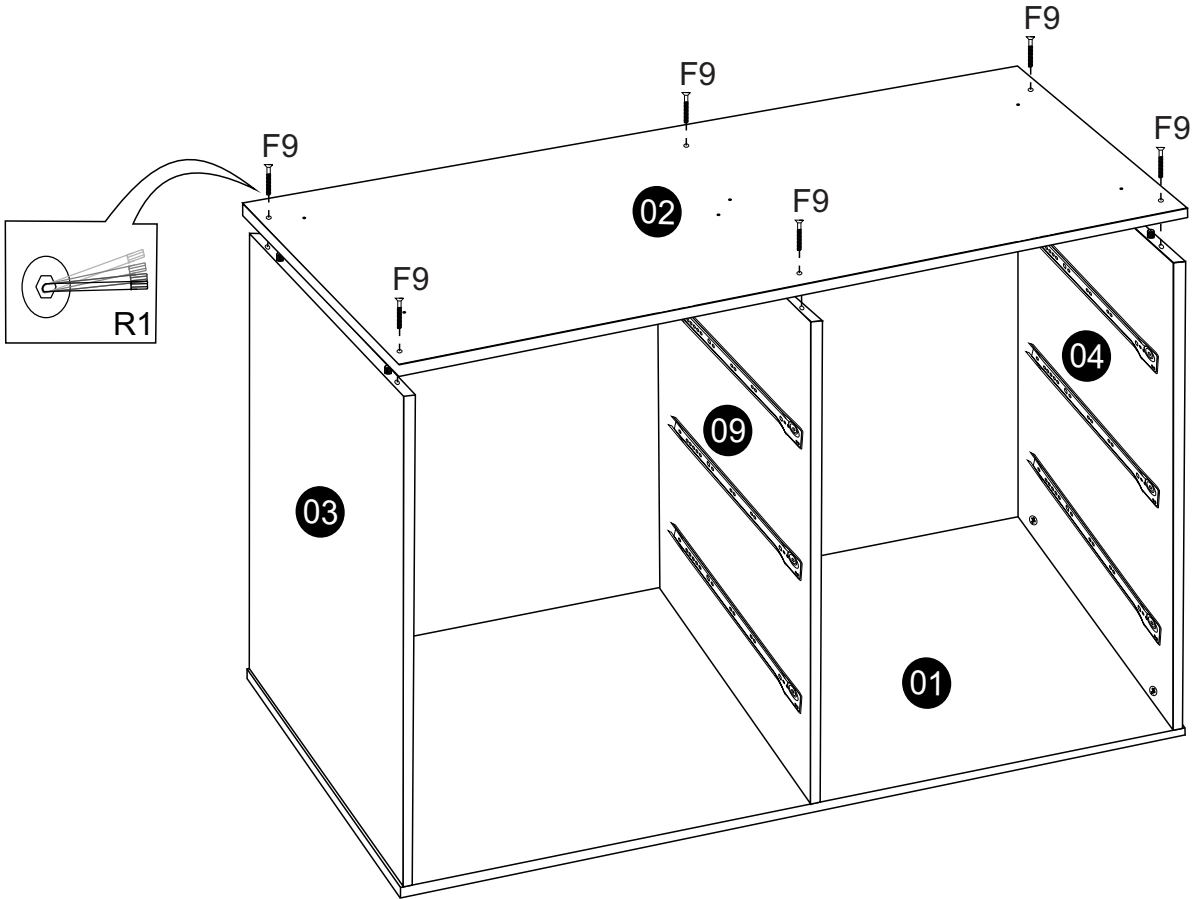
Base Superior + Lat. Direita + Lat. Esquerda + Base Inferior
Top Base + Left Side + Right Side + Botton Base
Base Superior + Lado Derecho + Lado Izquierdo + Base Inferior



F9		06 PCS
R1		01 PCS



Utilizar a chave Allen para fixar a base inferior nas laterais.
Use the key Allen to fix the lower base on the sides.
Usa la llave Allen para fijar la base inferior a los lados.

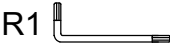

04

Conector de Fundo
Bottom Connector
Conector Inferior

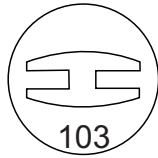

Branco por dentro
White inside
Blanco por dentro

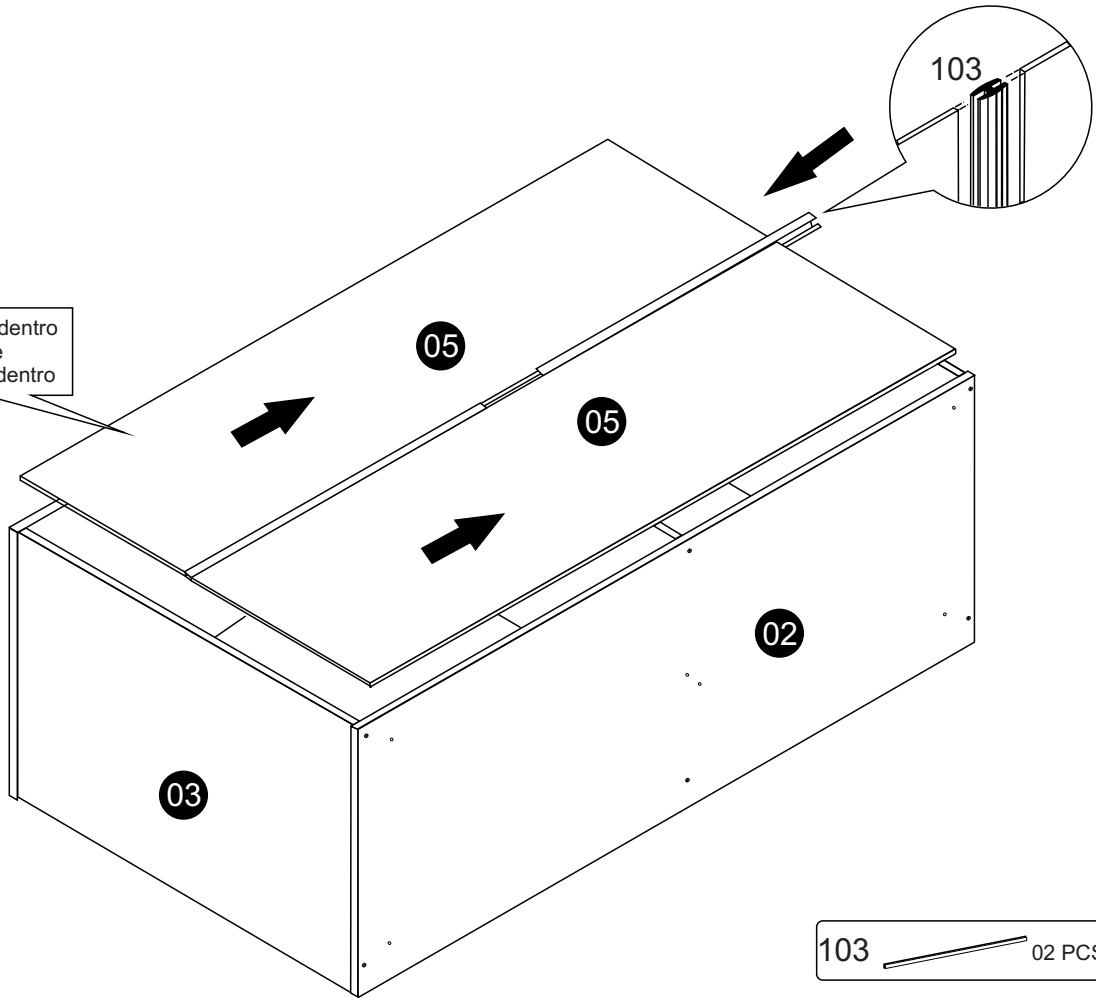

05

Conferir o esquadro da costa
Check the coast square
Revisa la plaza de la costa

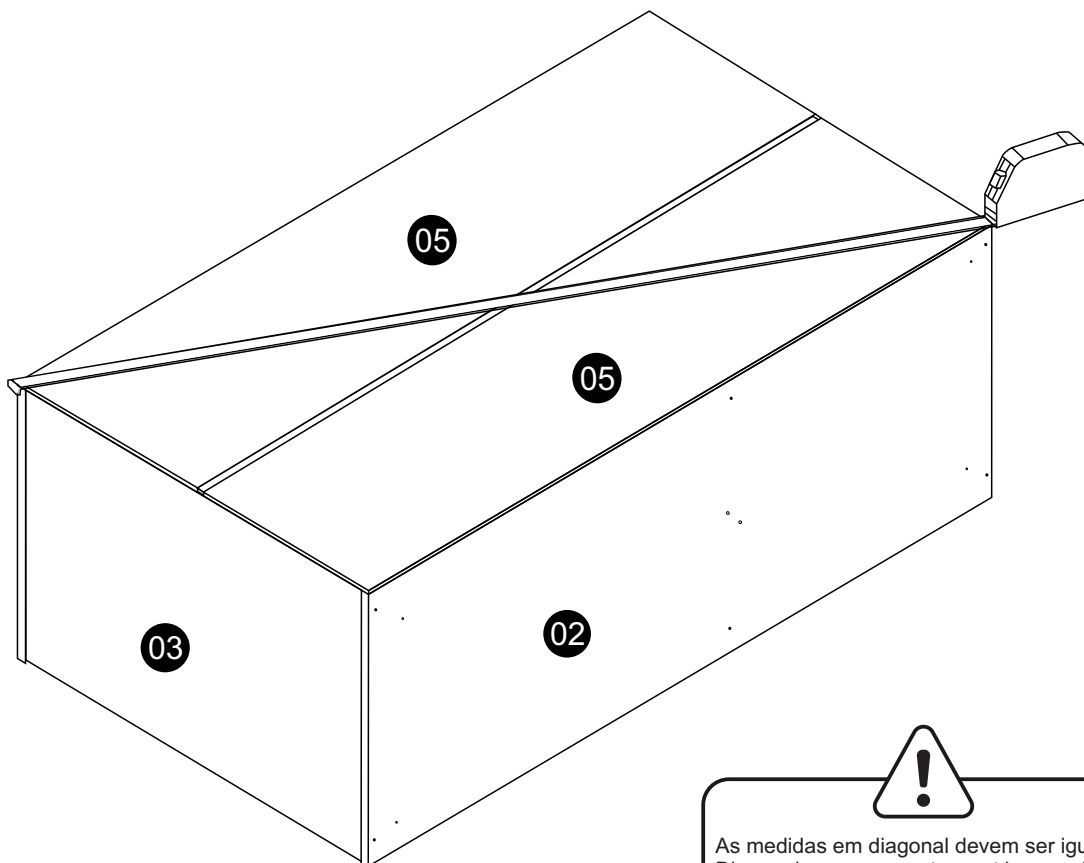

As medidas em diagonal devem ser iguais.
Diagonal measurements must be equal.
Medidas diagonales deben ser iguales.

06

Montagem da costa
Mounting of coast
Montaje del costa



Observe a quantidade de pregos necessários.
Note the amount of nails needed.
Tenga en cuenta la cantidad de clavos necesarios.

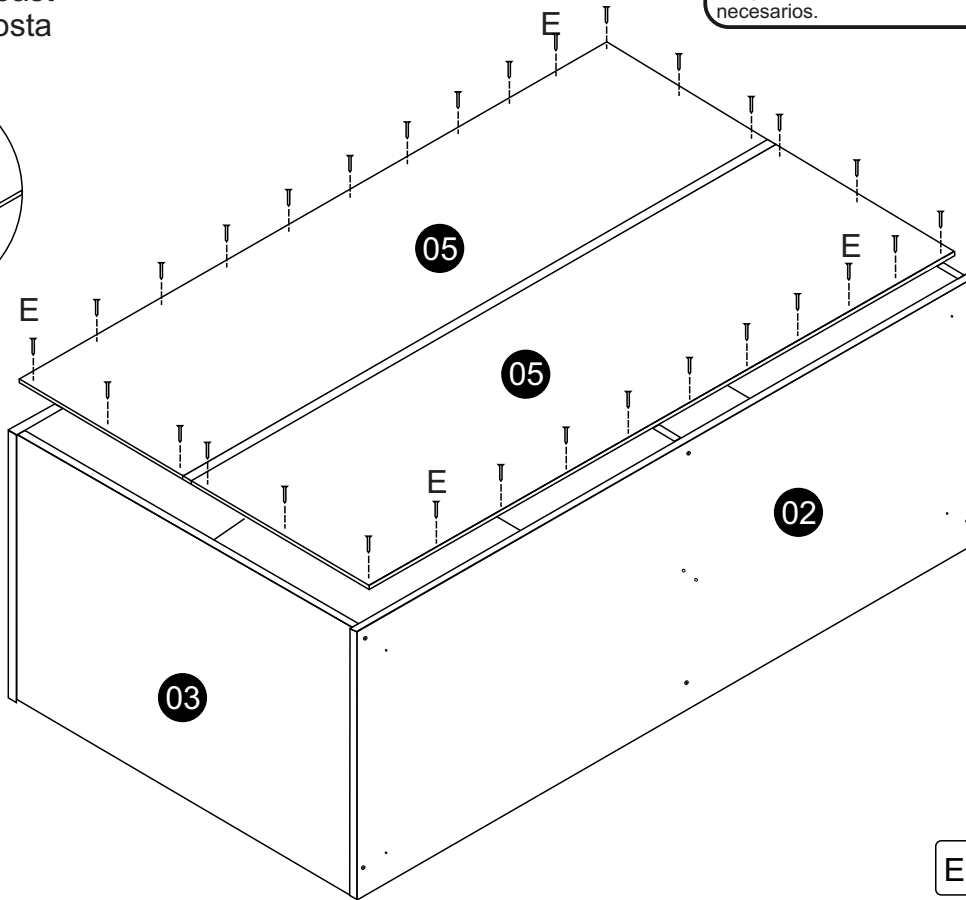
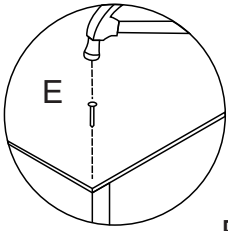

07

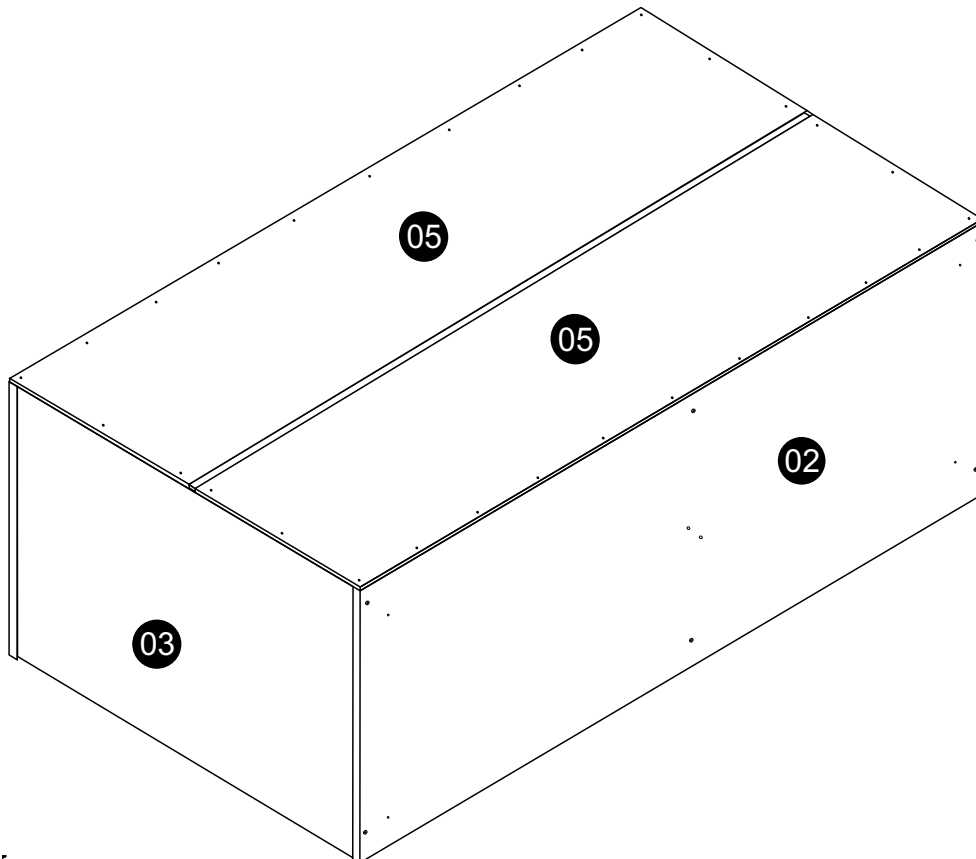

08

Travessas e pés
Board and feet
Tablas y pies

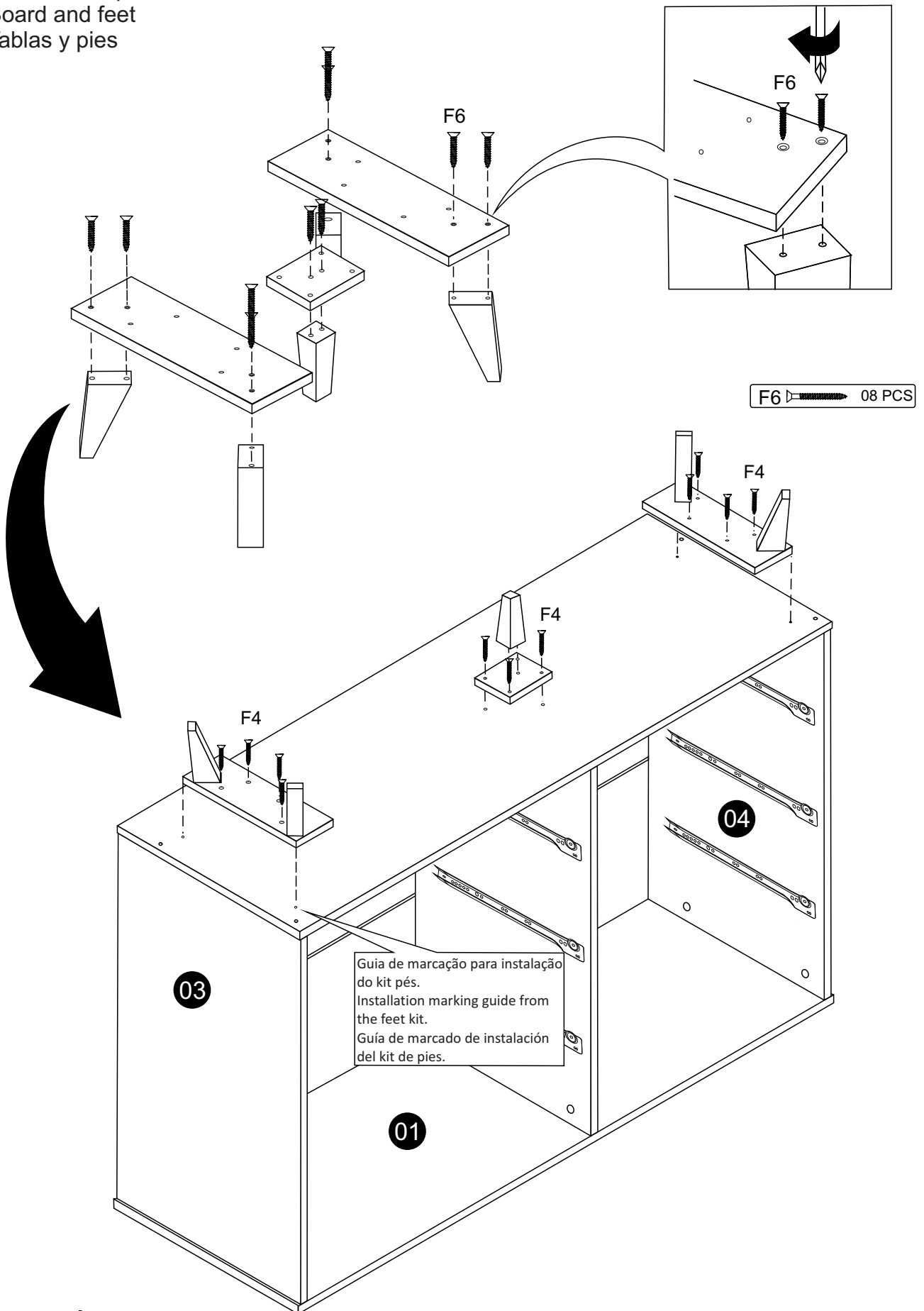

09

Kit Anti tombamento - Seguir o manual do produto
 Kit Anti tipping - Follow the product manual
 Kit Antivuelco - Siga el manual del producto

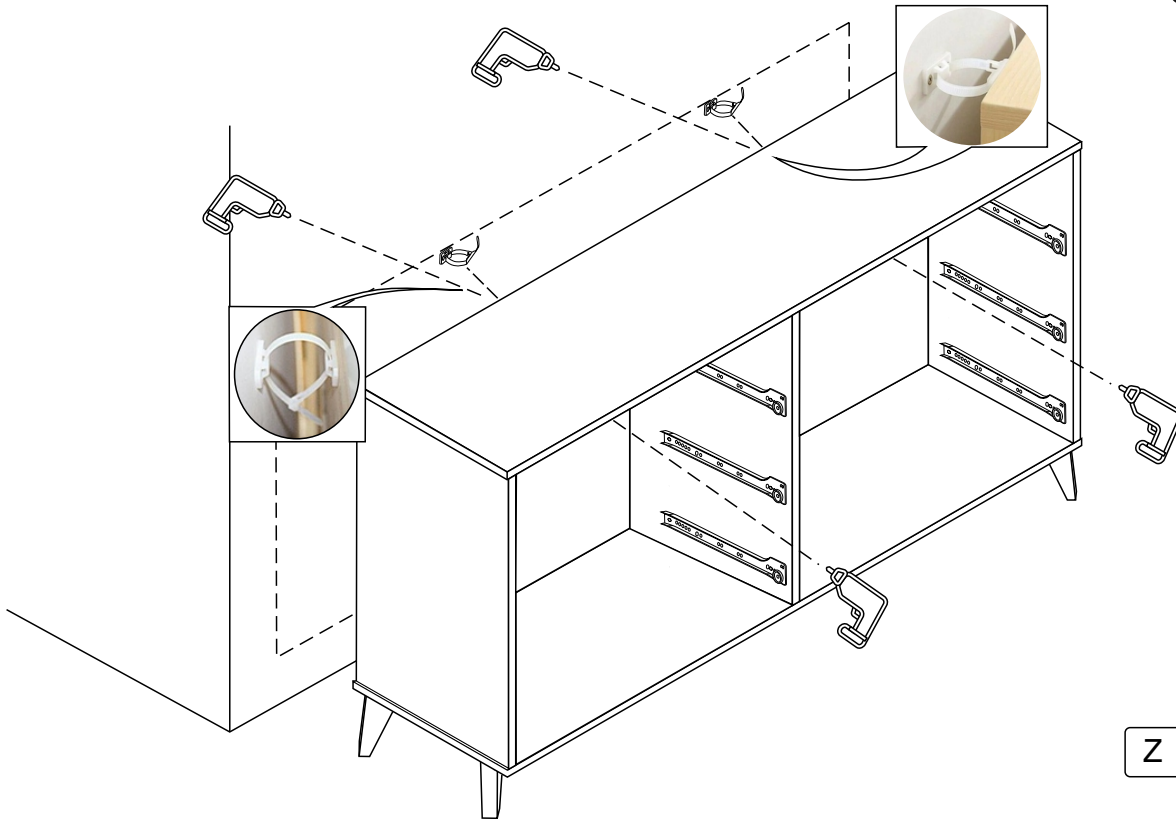

Z  02 PCS

10

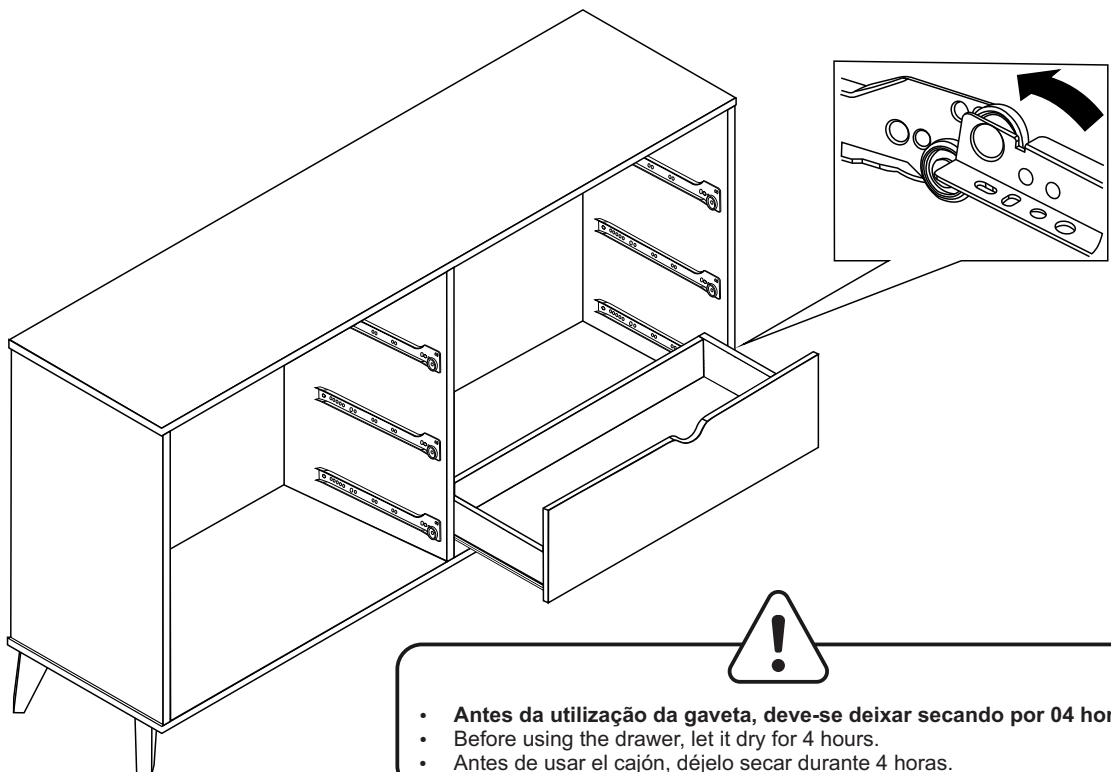



- Antes da utilização da gaveta, deve-se deixar secando por 04 horas.
- Before using the drawer, let it dry for 4 hours.
- Antes de usar el cajón, déjelo secar durante 4 horas.

11

Adesivo de atenção para primeira gaveta
First drawer attention sticker
Adhesivo atención primer cajón

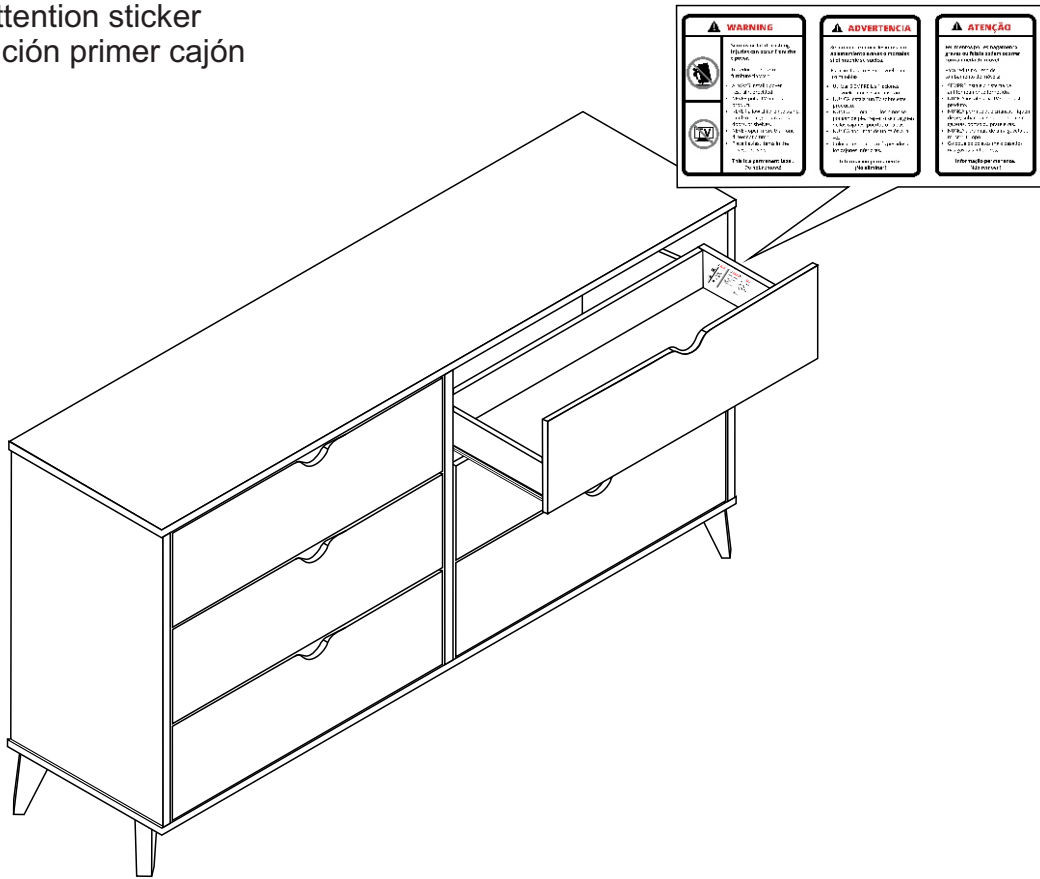

12

Finalizado
Finished
Acabado

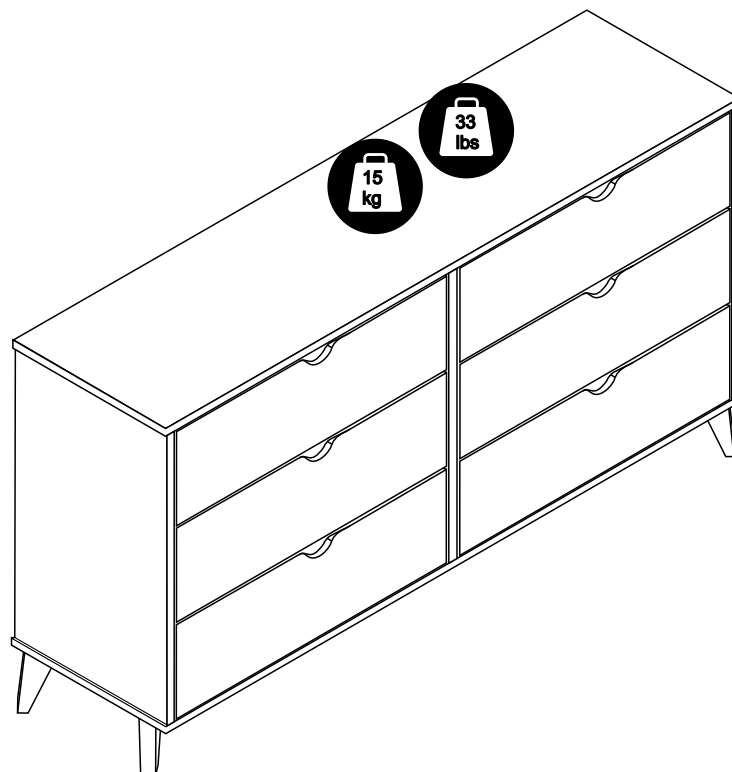



Ferimentos por esmagamentos graves ou fatais podem ocorrer com a queda do móvel.

Para reduzir o risco de tombamento de móveis:

- SEMPRE instale o sistema de antitombamento fornecido.
- NUNCA instale uma TV sobre esse produto.
- NUNCA permita que crianças fiquem em pé, subam ou se pendurem em gavetas, portas ou prateleiras.
- NUNCA abra mais de uma gaveta ao mesmo tempo.
- Coloque os objetos mais pesados nas gavetas inferiores.

Informação permanente.
Não remova!



Serious or fatal crushing injuries can occur from the tipover.

To reduce the risk of furniture tipover:

- ALWAYS install tipover restraint provided.
- NEVER put a TV on this product.
- NEVER allow children to stand, climb or hang on drawers, doors or shelves.
- NEVER open more than one drawer at a time.
- Place heaviest items in the lowest drawers.

This is a permanent label.
Do not remove!



Riesgo de aplastamiento graves o fatales en caso de caídas de los muebles.

Para reducir el riesgo de que los muebles se vuelquen:

- Instale siempre el sistema antivuelco proporcionado.
- NUNCA instale una TELE en este producto.
- NUNCA permita que los niños se paren, trepen o cuelguen de cajones, puertas o estantes.
- NUNCA abra más de un cajón al mismo tiempo.
- Coloque los objetos más pesados en los cajones inferiores.

Información permanente.
¡No retires!