











ACESSÓRIOS

A1	ADESIVO TAPA FUROS		6
B1	BUCHA M6X10		4
C1	CAVILHA DE MADEIRA 6X30		2
C5	CORREDIÇA SLIM 350MM		1
C8	CANTONEIRA PEQUENA 13X13		2
M1	TAMBOR MINIFIX		10
M2	HASTE MINIFIX		10
P1	PARAFUSO 3,5X14		12
P3	PARAFUSO 4X40		9
S1	SAPATA M6X14		4

VISTA EXPLODIDA

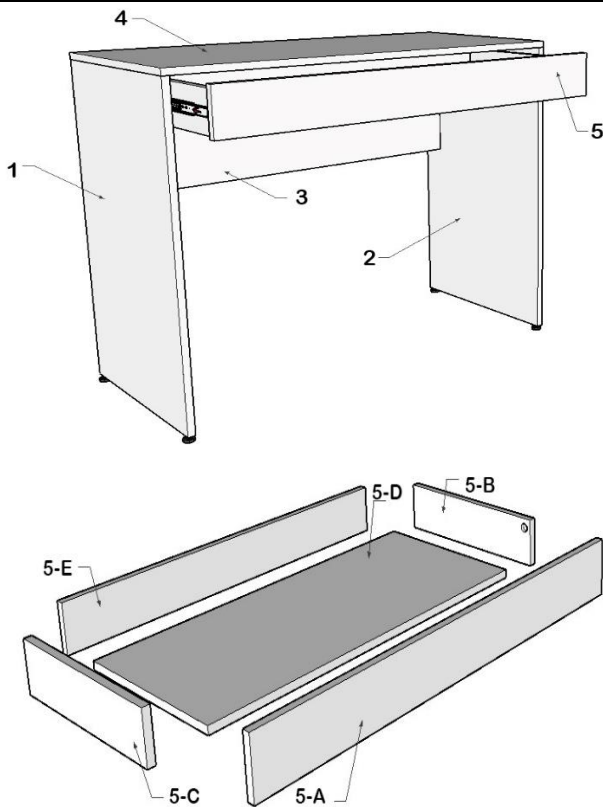

PEÇA	DESCRIÇÃO DA PEÇA	QUANTIDADE
1	PÉ ESQUERDO	1
2	PÉ DIREITO	1
3	SAIA	1
4	TAMPO PRINCIPAL	1
5	GAVETA	1
5-A	FRENTE DA GAVETA	1
5-B	LATERAL DIREITA DA GAVETA	1
5-C	LATERAL ESQUERDA DA GAVETA	1
5-D	BASE DA GAVETA	1
5-E	FUNDO DA GAVETA	1

PASSO 01

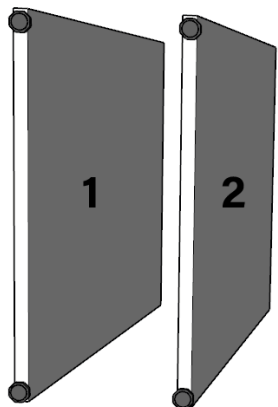

FIXAR AS BUCHAS "B1" NOS PÉS "1, 2".

EM SEGUIDA FIXE AS SAPATAS "S1".

PASSO 02

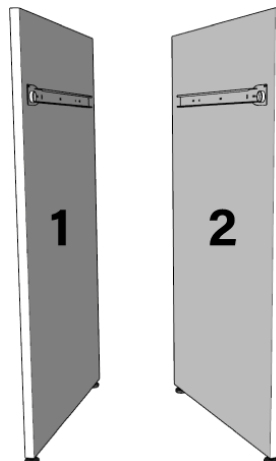

FIXAR A PARTE "1" DA CORREDIÇA "C5" NAS LATERAIS "1, 2" USANDO DOIS PARAFUSOS "P1" EM CADA LATERAL.

PASSO 03

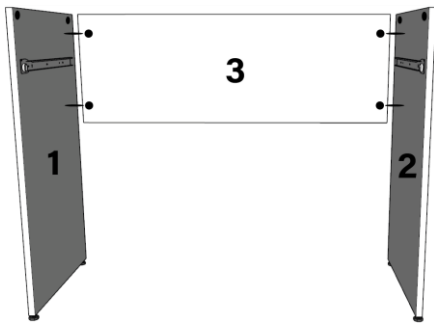

FIXAR A SAIA "3" NOS PÉS "1, 2".

USE A HASTE "M2" NOS PÉS "1, 2" E O TAMBOR "M1" NA SAIA "3".

PASSO 04

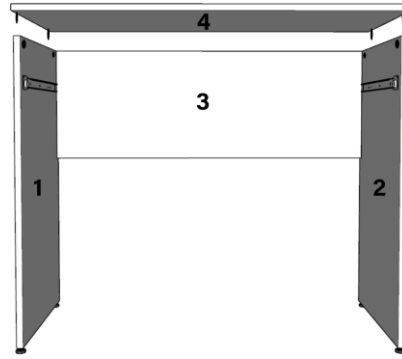

FIXAR O TAMPO "4" NOS PÉS "1, 2".

USE A HASTE "M2" NO TAMPO "4" E O TAMBOR "M1" NOS PÉS "1, 2".

PASSO 05

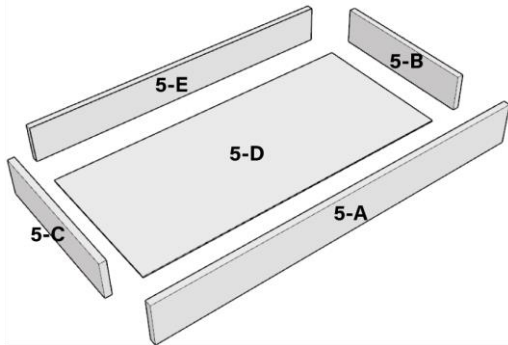

FIXAR AS LATERAIS "5-B, 5-C" NA FRENTE "5-A".

UTILIZE A CAVILHA "C1" NAS LATERAIS "5-B, 5-C".

NA FRENTE "5-A" USE A HASTE "M2".

APÓS, FIXE O TAMBOR "M1" NAS LATERAIS E APERTE-OS.

FIXAR A BASE "5-D" NAS LATERAIS "5-B, 5-C" USANDO DOIS PARAFUSOS "P3" EM CADA LATERAL.

FIXAR O FUNDO "5-E" NAS LATERAIS "5-B, 5-C" USANDO O PARAFUSO "P3".

PASSO 06

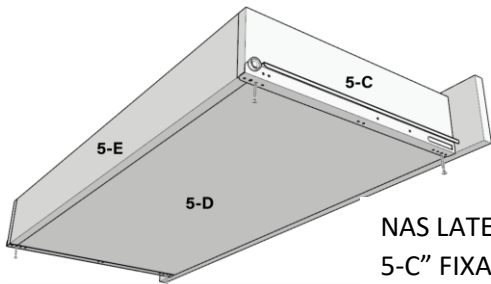

NAS LATERAIS "5-B, 5-C" FIXAR A PARTE 2 DA CORREDIÇA "C5" USANDO DOIS PARAFUSOS "P1".

PASSO 07

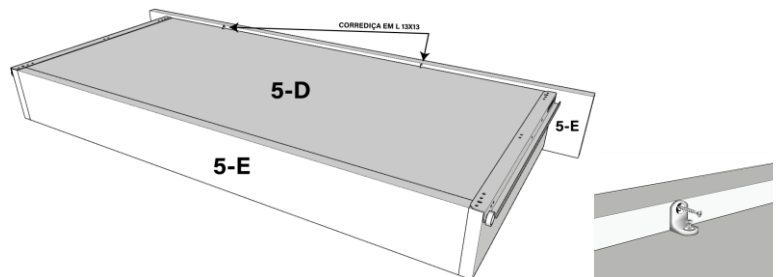

FIXAR AS CANTONEIRAS "C8" USANDO PARAFUSOS "P1".

IMAGEM PRODUTO PRONTO

