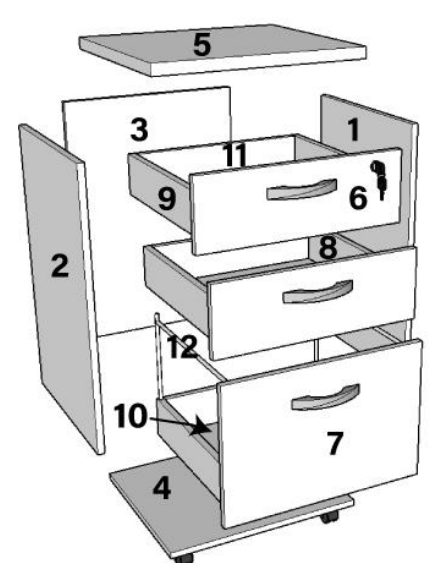

MANUAL DE MONTAGEM GAVETEIRO VOLANTE 2 GAVETAS + 1 GAVETA PARA PASTA

ACESSÓRIOS

A1	ADESIVO TAPA FURO		6
B2	BATENTE L P/ FECHADURA		1
C1	CAVILHA DE MADEIRA 6X30		18
C5	CORREDIÇA SLIM 350MM		2
C6	CORREDIÇA TELESCÓPICA 350MM		1
D1	DISTANCIADOR DE FECHADURA		1
F1	PUXADOR		3
F2	FECHADURA		1
M1	TAMBOR MINIFIX		10
M2	HASTE MINIFIX ROSCA SOBERBA		10
P1	PARAFUSO GERAL 3,5X14		44
P2	PARAFUSO 4,5X25		6
P3	PARAFUSO 4X40		16
R1	RODINHAS RODÍZIO		4
T1	SUPORE PASTA SUSPENSA		2

VISTA EXPLODIDA	PEÇA	DESCRIÇÃO DA PEÇA	QUANTIDADE
	1	LATERAL GAVETEIRO VOLANTE DIREITA	1
	2	LATERAL GAVETEIRO VOLANTE ESQUERDA	1
	3	COSTAS	1
	4	BASE	1
	5	TAMPO	1
	6	FRENTE GAVETEIRO VOLANTE	2
	7	FRENTE GAVETA COM PASTA SUSPENSA	1
	8	LATERAL DE GAVETA DIREITA	3
	9	LATERAL DE GAVETA ESQUERDA	3
	10	EUCAPLAC	3
	11	FUNDO DA GAVETA	3
	12	SUPORE DE PASTA SUSPENSA	2

PASSO 01

PASSO 02

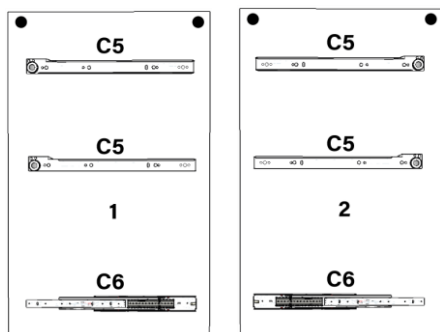

FIXAR CORREDIÇAS "C5" E "C6" NAS LATERAIS "1" E "2" USANDO PARAFUSO "P1".

ATENTE-SE QUE A CORREDIÇA "C6" DEVE FICAR NA PARTE INFERIOR.

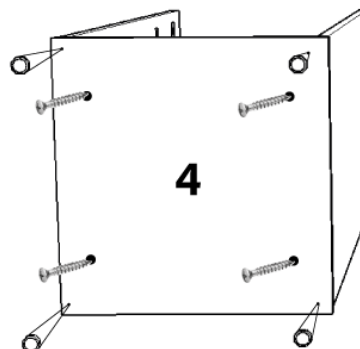

FIXAR 4 PARAFUSOS 4X40 "P3" NA BASE "4" NAS DEVIDAS MARCAÇÕES JÁ EXISTENTES.

PASSO 02

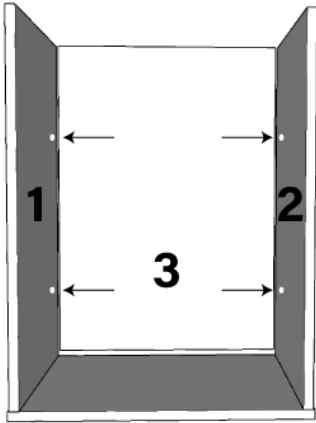

FIXAR COSTA "3" NAS
LATERAIS "1, 2" USANDO
CAVILHA "C1".

PASSO 03

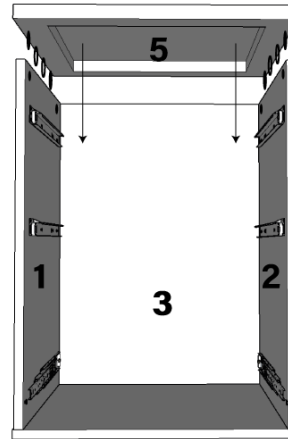

FIXAR TAMPO "5" NAS
LATERAIS "1, 2".

USE CAVILHA "C1" + HASTE
MINIFIX "M2" PARA FIXAR O
TAMPO "5", APÓS, ENCAIXE
O TAMBOR MINIFIX "M1"
NAS LATERAIS "1, 2" E
APERTE-OS.

PASSO 04

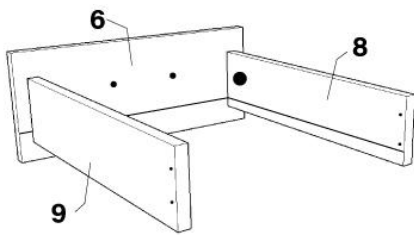

FIXAR LATERAIS "8, 9" NA FRENTE "6".

UTILIZE HASTE "M2" + CAVILHAS "C1" NA
FRENTE DA GAVETA "6" E TAMBORES
MINIFIX "M1" NAS LATERAIS "8, 9".

FIXAR PUXADOR "F1" USANDO
2 PARAFUSOS 4,5X25 "P2".

FIXAR FECHADURA "F2" +
DISTANCIADOR "D1" NA PEÇA
"6" USANDO PARAFUSO 3,5X14
"P1".

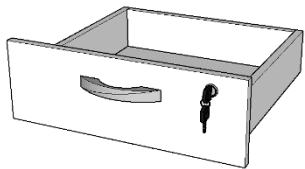

PASSO 05

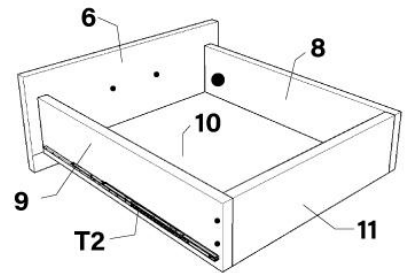

ENCAIXAR EUCAPLAC "10" AO RESTANTE DA GAVETA.
FIXAR FUNDO "11" NAS LATERAIS "8, 9" UTILIZANDO
PARAFUSOS "P3".

FIXAR CORREDIÇAS "C5" NAS LATERAIS "8, 9"
UTILIZANDO PARAFUSOS 3,5X14 "P1".

PASSO 05

FIXAR PEÇAS "8, 9" NA PEÇA "7".

USE HASTE "M2" + CAVILHA "C1" NA FRENTE E
TAMBOR "M1" NAS LATERAIS. APÓS, ENCAIXAR
EUCAPLAC "10".

FIXAR CORREDIÇAS "C6" NA MARCAÇÃO DAS
LATERAIS "8, 9" USANDO PARAFUSO "P1".

FIXAR A PEÇA "11" NAS LATERAIS "8, 9" USANDO
PARAFUSO "P3". E ENTÃO ENCAIXAR OS
SUPORTES "12".

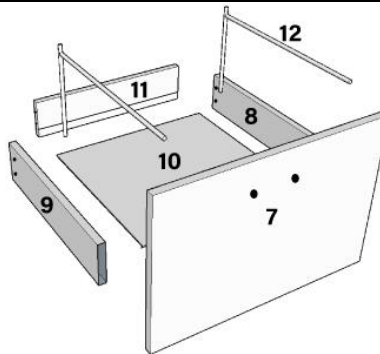

PASSO 06

FIXE AS RODINHAS
RODÍZIO "R1" USANDO
PARAFUSOS "P1".

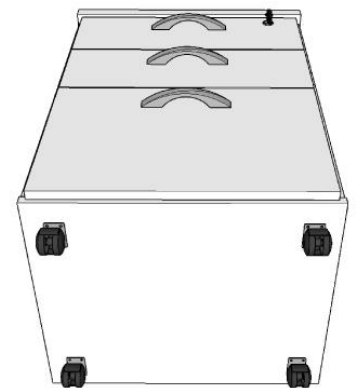

IMAGEM PRODUTO MONTADO

