

BANCADA ILHA COZINHA / ISLAND KITCHEN COUNTERTOP / ENCIMERA DE COCINA CON ISLA
PH-3069

Montagem

Recomenda-se a leitura prévia das instruções de montagem e profissionais especializados para montar.

Assistência

Caso ocorra problema com algum dos componentes, sublinhe-o, identifique o problema e retorne esta relação, via fax ou outro meio de comunicação disponível para o representante.

Assinatura do cliente

Assembly

Before the assembling is recommended to read carefully the assembly instruction by professional assemblers.

Assistance

If happen problems with any component, underline the same, identify the problem and send back this relation immediately, by fax or other way.

Client signature

Montaje

Se recomienda la lectura previa de las instrucciones de montaje y profesionales especializados para montarlos.

Assistencia

Caso sucedan problemas con alguno de los componentes, subraye el componente, identifique el problema, y retorne esta copia via fax u otro medio de comunicación posible.

Assinatura del cliente

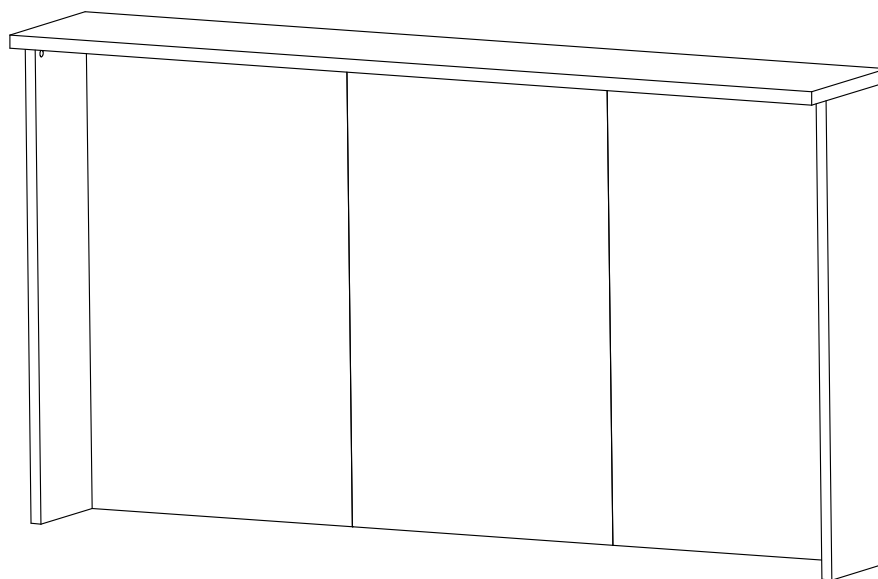

Atenção / Attention / Atención

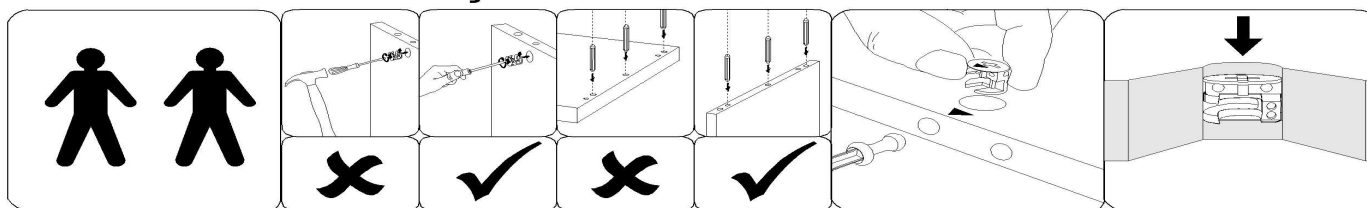

A Heval se reserva o direito de efetuar alterações nos produtos de suas linhas sem aviso prévio, quando entender necessário.

Herval reserves the right to effect modifications in the products, without previous advice, when understand necessary.

Herval se reserva el derecho de hacer las modificaciones que juzgue necesarias en sus productos, sin aviso previo, cuando lo crea necesario.

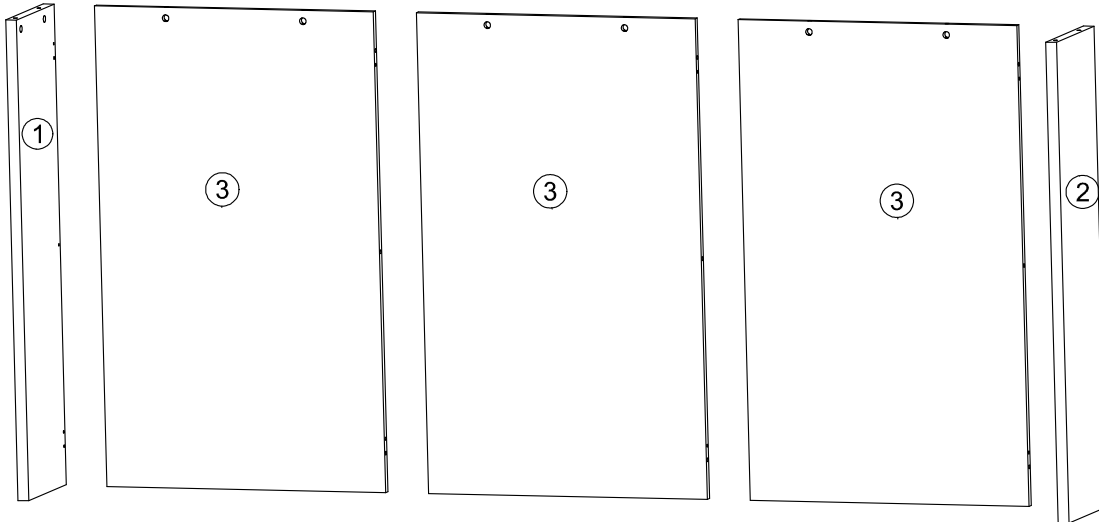
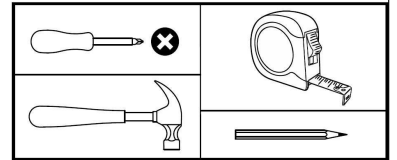

LISTA DE PEÇAS / PARTS LIST / LISTA DE PIEZAS

Volume 1 / Carton 1 / Caja 1

ÍNDICE / INDEX	CÓD. / CODE	PEÇA / PART / PIEZA	MED/MEASURE	QTDE / QUANT / CANT
1	159644E	LATERAL ESQUERDA	1070.0x257.0x25.0	1
2	159643E	LATERAL DIREITA	1070.0x257.0x25.0	1
3	159649E	TRASEIRO	650.0x1070.0x15.0	3
-	K072709	PH3069 BANCADA ILHA COZINHA TEN 200CM	xx	1

Volume 2 / Carton 2 / Caja 2

ÍNDICE / INDEX	CÓD. / CODE	PEÇA / PART / PIEZA	MED/MEASURE	QTDE / QUANT / CANT
4	F3069	F3069 TAMPO-ENGROSSADO 30MM	xx	1

LISTA DE ACESSÓRIOS / FITTINGS LIST / LISTA DE ACCESORIOS

CÓD./ CODE: K072709

REF.	PEÇA	PART	PIEZA	QTDE	CÓDIGO
A	PARAFUSO MINIFIX DU255	Cam Bolt 32xØ6mm	Perno de Leva 32xØ6mm	4	1602006
B	TAMBOR MINIFIX Ø14.9X11MM	Can Nut Ø15 mm	Porca de Leva Ø15 mm	28	1605358
C	CANTONEIRA 18x18 (ZA)	ANGLE 18X18	ANGULO 18X18	12	1604580
D	BUCHA 8mm	Wall Plug 8mm	Enchufe de Pared 8mm	4	1602625
E	SUPORTE FIXAÇÃO AÉREO	AIR SUPPORT FIXING	APOYO FIJACIÓN AIRE	4	-
F	PROTECAO SUPORTE FIXAÇÃO AÉREO	Protection Support Fitting Airspace	Protección Soporte Montaje de Aireo	4	-
G	HASTE SEM ANEL 49MM (09.02.130)	RINGLESS ROD 49MM	RODA SIN ANILLO 49MM	6	1607800
H	TAPA FURO ADESIVO PAPEL 22MM	SLAP HOLE ADHESIVE PAPER 22MM	PAPEL ADHESIVO SLAP HOLE 22MM	28	XXXXXXXX
I	CAVILHA DE MADEIRA 6X40	Dowel Ø6 x 40 mm	Tarugo Ø6 x 40 mm	4	1604742
J	CAVILHA DE MADEIRA 6X60	Dowel Ø6 x 60 mm	Tarugo Ø6 x 60 mm	4	1606637
K	SAPATA NIQUELADA 20mm	NIQUELADA SHOE 20MM	ZAPATO NIQUELADA 20MM	7	-
L	PARAFUSO 4 X 14 CAB. CHATA REBAIXADA PHILIPS	Screw Ø4 x 14 mm	Tornillo Ø4 x 14 mm	36	1602420
M	PARAFUSO 6 X 60 CAB. FLANGEADO	Screw Ø6 x 60 mm	Tornillo Ø6 x 60 mm	4	1606857
N	PARAFUSO 4 X 25 CAB. CHATA PHILIPS	Screw Ø4 x 25 mm	Tornillo Ø4 x 25 mm	4	1607862

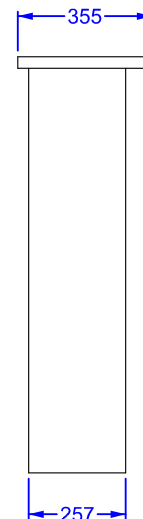
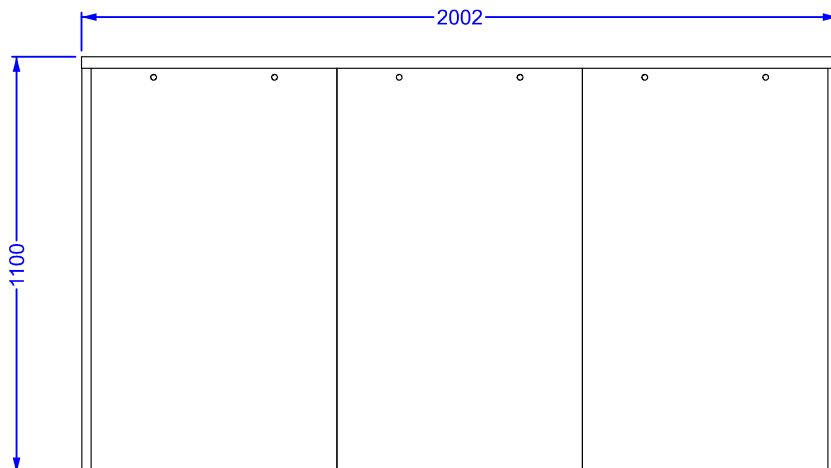



PASSO 1
STEP 1
PASO 1

PEÇAS NECESSÁRIAS
PARTS REQUIRED
PIEZAS NECESARIAS

INDICE	QUANT.
3	3

FERRAGEM NECESSÁRIA
HARDWARE REQUIRED
HERRAMIENTA NECESSARIA

INDICE	IMAGEM	QTDE
I		4
J		4
K		3

FERRAMENTAS NECESSÁRIAS
TOOL REQUIRED
HERRAMIENTA NECESSARIA

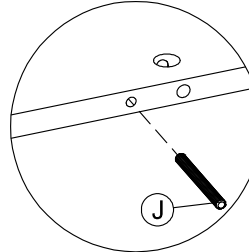
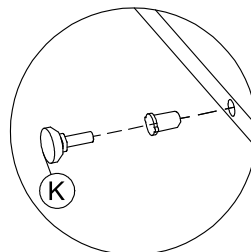
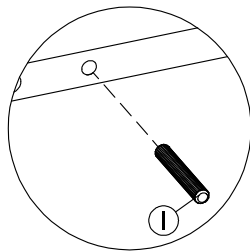
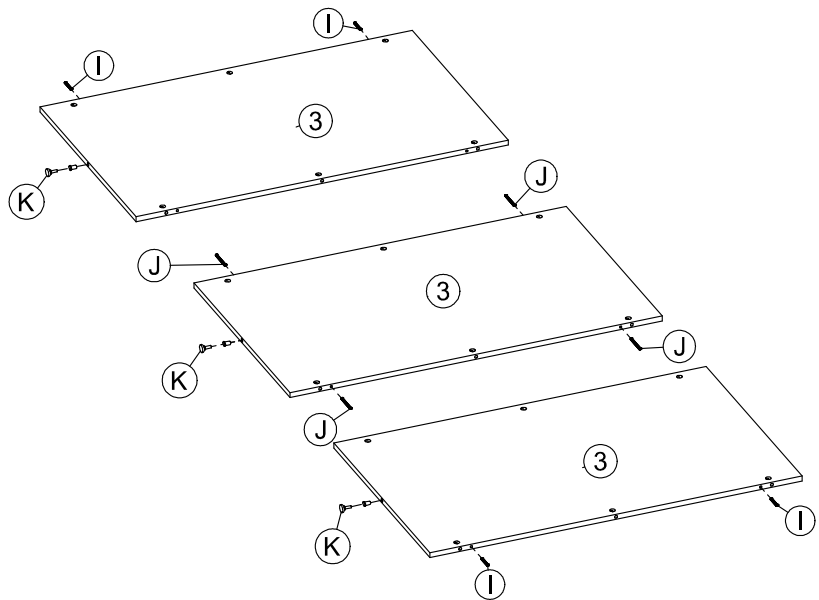
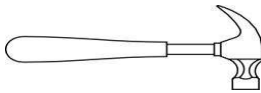



PASSO 2
STEP 2
PASO 2

PEÇAS NECESSÁRIAS
PARTS REQUIRED
PIEZAS NECESARIAS

INDICE	QUANT.
2	1
4	1

FERRAGEM NECESSÁRIA
HARDWARE REQUIRED
HERRAMIENTA NECESSARIA

INDICE	IMAGEM	QTDE
A		16
K		4

FERRAMENTAS NECESSÁRIAS
TOOL REQUIRED
HERRAMIENTA NECESSARIA

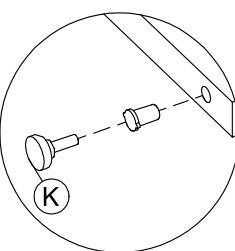
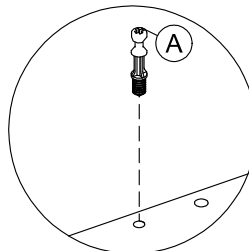
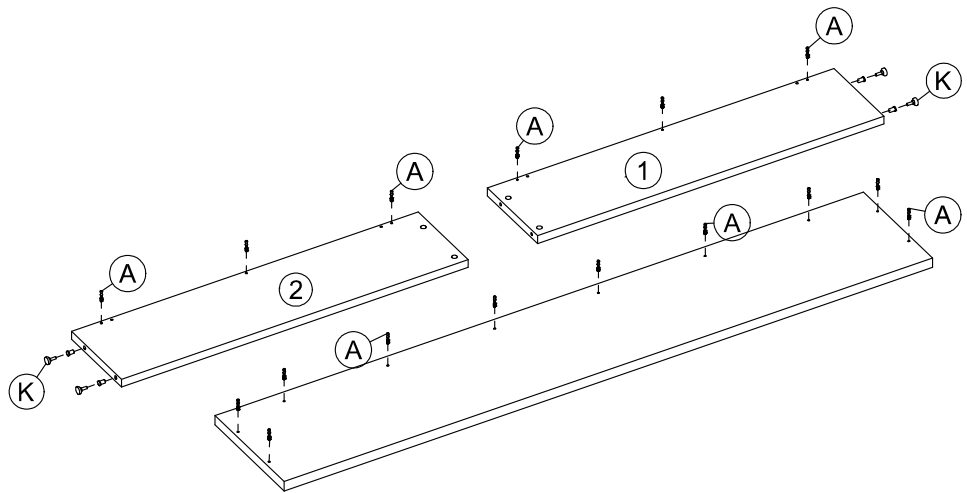
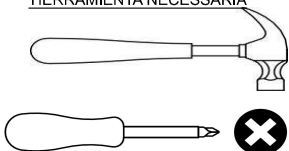

**PASSO 3
STEP 3
PASO 3**

PEÇAS NECESSÁRIAS
PARTS REQUIRED
PIEZAS NECESARIAS

INDICE	QUANT.
2	1
3	1

FERRAGEM NECESSÁRIA
HARDWARE REQUIRED
HERRAMIENTA NECESARIA

INDICE	IMAGEM	QTDE
B		3

FERRAMENTAS NECESSÁRIAS
TOOL REQUIRED
HERRAMIENTA NECESARIA

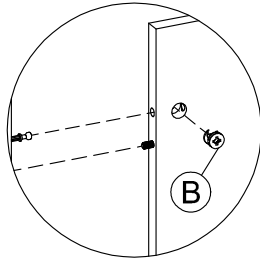
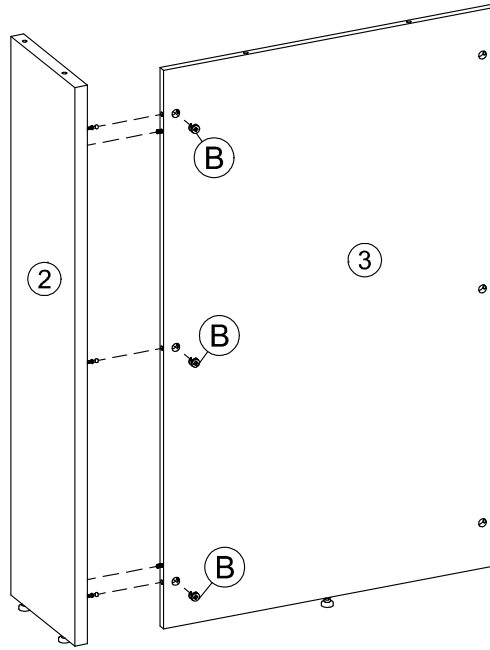
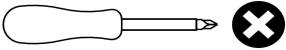

**PASSO 4
STEP 4
PASO 4**

PEÇAS NECESSÁRIAS
PARTS REQUIRED
PIEZAS NECESARIAS

INDICE	QUANT.
1	1
3	1

FERRAGEM NECESSÁRIA
HARDWARE REQUIRED
HERRAMIENTA NECESARIA

INDICE	IMAGEM	QTDE
B		3

FERRAMENTAS NECESSÁRIAS
TOOL REQUIRED
HERRAMIENTA NECESARIA

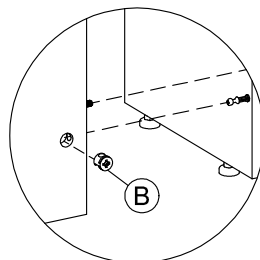
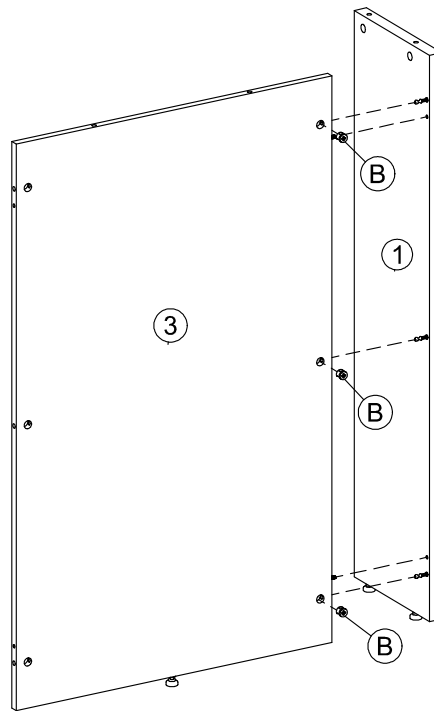
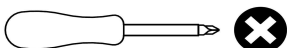

**PASSO 5
STEP 5
PASO 5**

PEÇAS NECESSÁRIAS
PARTS REQUIRED
PIEZAS NECESARIAS

INDICE	QUANT.
3	3

FERRAGEM NECESSÁRIA
HARDWARE REQUIRED
HERRAMIENTA NECESARIA

INDICE	IMAGEM	QTDE
B		12
G		6

FERRAMENTAS NECESSÁRIAS
TOOL REQUIRED
HERRAMIENTA NECESARIA

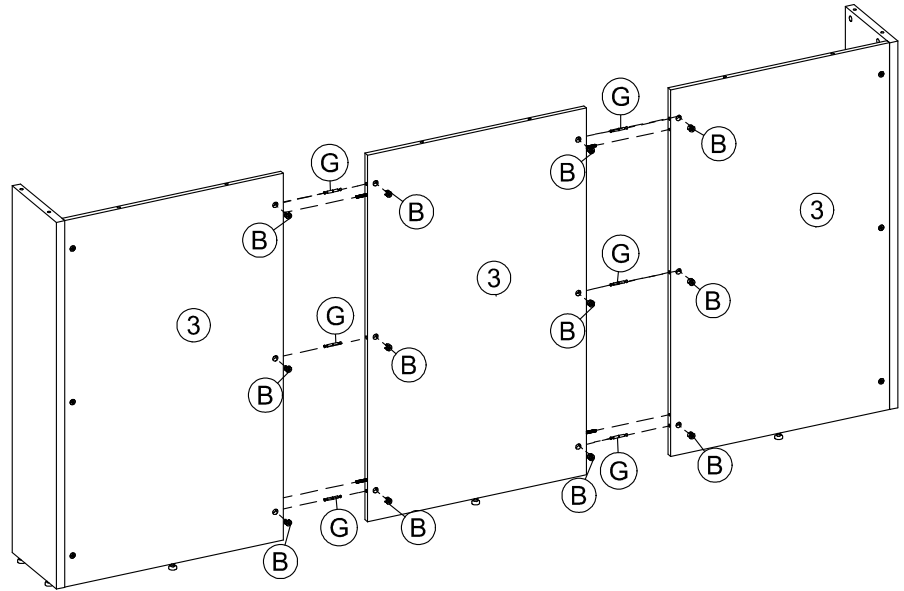
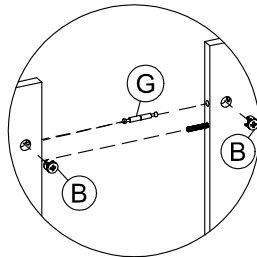
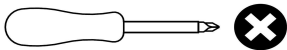

**PASSO 6
STEP 6
PASO 6**

PEÇAS NECESSÁRIAS
PARTS REQUIRED
PIEZAS NECESARIAS

INDICE	QUANT.
4	1

FERRAGEM NECESSÁRIA
HARDWARE REQUIRED
HERRAMIENTA NECESARIA

INDICE	IMAGEM	QTDE
B		10

FERRAMENTAS NECESSÁRIAS
TOOL REQUIRED
HERRAMIENTA NECESARIA

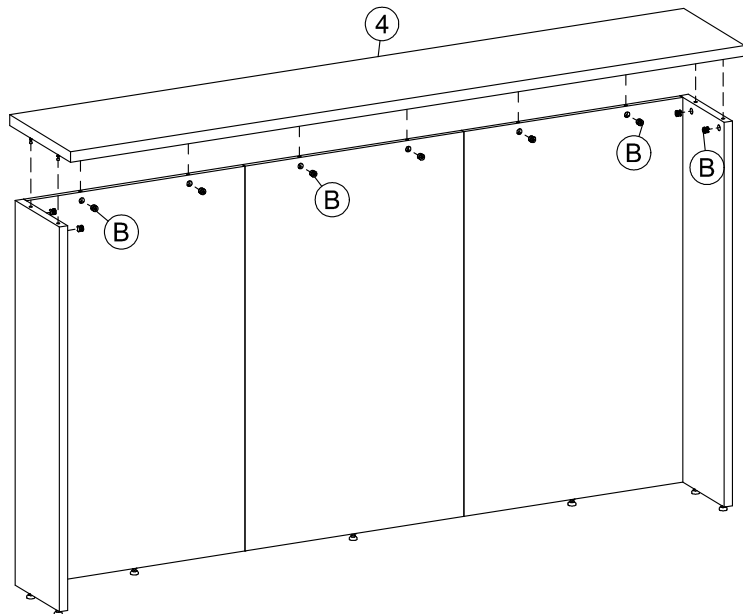
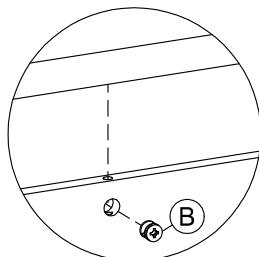
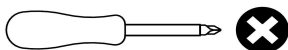

**PASSO 7
STEP 7
PASO 7**

PEÇAS NECESSÁRIAS
PARTS REQUIRED
PIEZAS NECESARIAS

FERRAGEM NECESSÁRIA
HARDWARE REQUIRED
HERRAMIENTA NECESARIA

INDICE	IMAGEM	QTDE
H		18

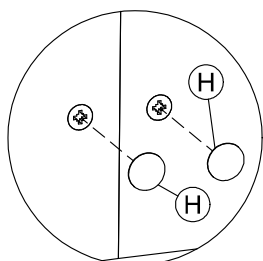
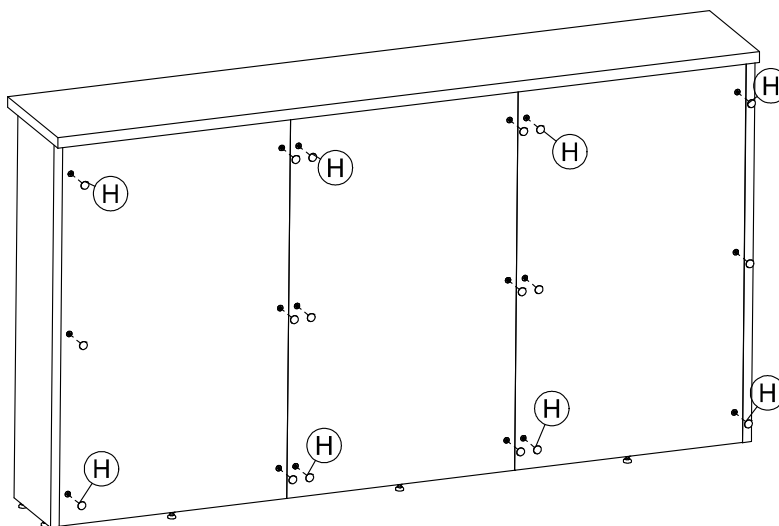
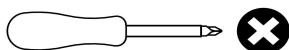

FERRAMENTAS NECESSÁRIAS
TOOL REQUIRED
HERRAMIENTA NECESARIA



**PASSO 8
STEP 8
PASO 8**

PEÇAS NECESSÁRIAS
PARTS REQUIRED
PIEZAS NECESARIAS

FERRAGEM NECESSÁRIA
HARDWARE REQUIRED
HERRAMIENTA NECESARIA

INDICE	IMAGEM	QTDE
C		12
L		24

FERRAMENTAS NECESSÁRIAS
TOOL REQUIRED
HERRAMIENTA NECESARIA

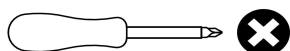

**ATENÇÃO!!!!
O MÓVEL PODE SER UTILIZADO DE DIFERENTES FORMAS.
SIGA AS INSTRUÇÕES DOS PASSOS SEGUINTE PARA SUA SEGURANÇA**



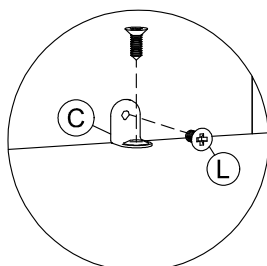
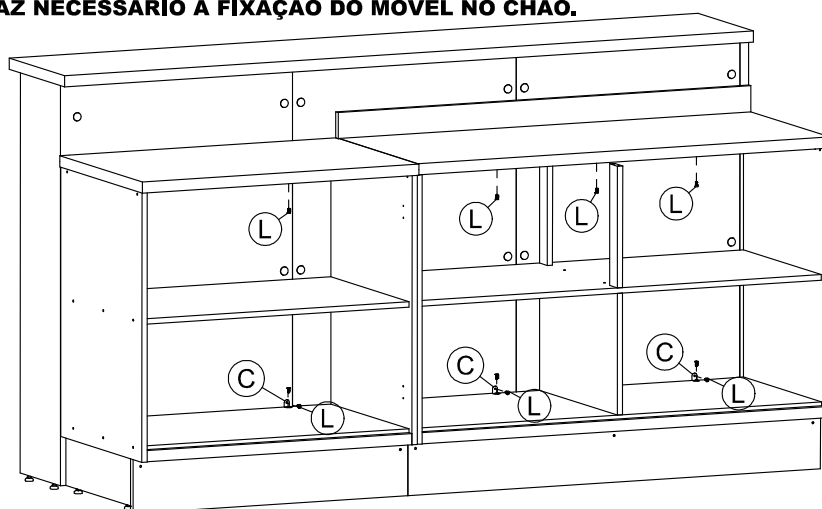

**QUANDO UTILIZAR O MÓVEL NO FUNDO DO BALCÃO,
NÃO SE FAZ NECESSÁRIO A FIXAÇÃO DO MÓVEL NO CHÃO.**



**PASSO 9
STEP 9
PASO 9**

PEÇAS NECESSÁRIAS
PARTS REQUIRED
PIEZAS NECESARIAS

FERRAGEM NECESSÁRIA
HARDWARE REQUIRED
HERRAMIENTA NECESARIA

INDICE	IMAGEM	QTDE
E		4
F		4
L		12
M		4

FERRAMENTAS NECESSÁRIAS
TOOL REQUIRED
HERRAMIENTA NECESARIA

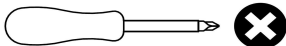



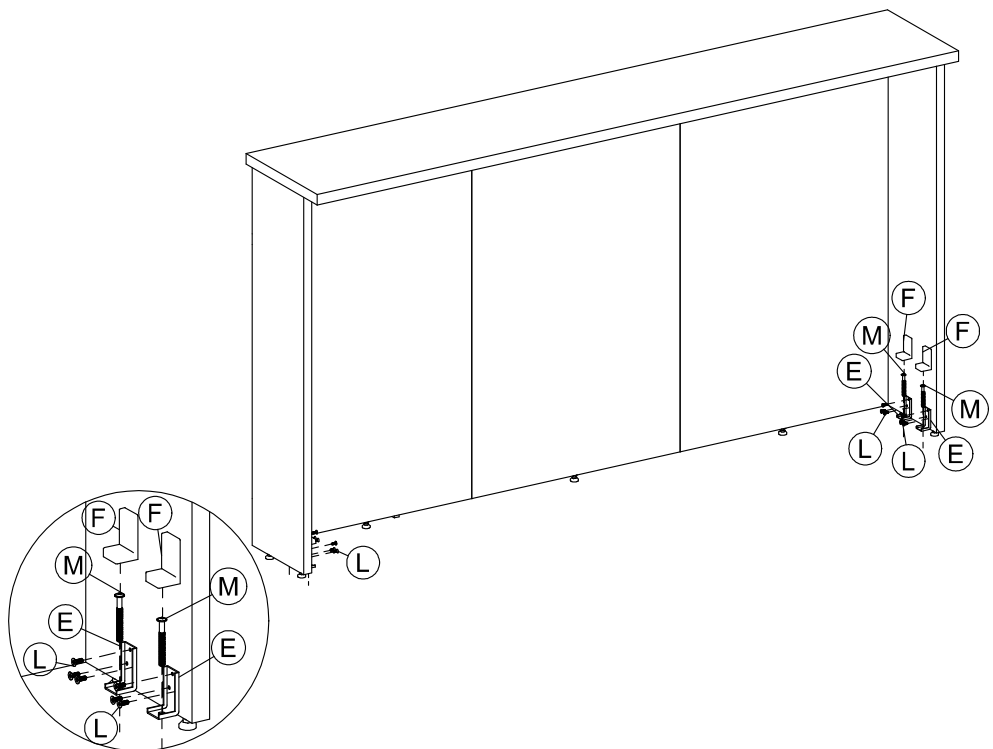

**QUANDO UTILIZAR O MÓVEL COMO UM PRODUTO INDEPEDENTE,
SE FAZ NECESSÁRIO A FIXAÇÃO DO MÓVEL NO CHÃO.**



**PASSO 10
STEP 10
PASO 10**

PEÇAS NECESSÁRIAS
PARTS REQUIRED
PIEZAS NECESARIAS

FERRAGEM NECESSÁRIA
HARDWARE REQUIRED
HERRAMIENTA NECESARIA

INDICE	IMAGEM	QTDE
E		4
F		4
L		12
M		4
N		4

FERRAMENTAS NECESSÁRIAS
TOOL REQUIRED
HERRAMIENTA NECESARIA

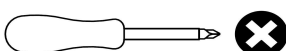

**QUANDO UTILIZAR O MÓVEL NA LATERAL DO BALCÃO,
SE FAZ NECESSÁRIO A FIXAÇÃO DO MÓVEL NO CHÃO E
NA LATERAL DO BALCÃO.**

