

ME-4185

Instruções de Montagem Assembly Instructions Instrucciones de Armado

Acesse Vídeos de Montagens
Access Mounting Videos
Acceder a los Vídeos de Montaje
www.tecnomobili.ind.br

tecnomobili

Estrada RSC 453, Km s/n° | Garibaldi | RS
CEP: 95720-000 | Fone / Fax: 54.3464.2050
sac@moveisvideira.com.br

Notas Especiais:

01 -Examine completamente todas as peças do móvel antes de começar o trabalho.

02 -Recomenda-se montar o móvel conforme este Manual de Montagem.

03 -É de responsabilidade do montador seguir as instruções do Manual de Montagem, que são fundamentais para garantir a estrutura do móvel.

04 -Para limpeza, utilizar somente pano úmido e sabão neutro.

Special notes:

01 -Check all parts of the unit thoroughly before starting work.

02 -It is recommended to assemble the furniture according to this Installation Manual.

03 -It is the responsibility of the assembler to follow the instructions in the Assembly Manual, which are essential to ensure the structure of the furniture.

04 -For cleaning use only damp cloth and neutral soap.

Notas especiales:

01 -Examine completamente todas las piezas del mueble antes de iniciar el trabajo.

02 -Se recomienda montar el mueble conforme el Manual de Ensamblaje.

03 -Es de responsabilidad del montador seguir las instrucciones del Manual de Ensamblaje, que son fundamentales para garantizar la estructura del mueble.

04 -Para limpieza solamente usar trapo húmedo y jabón neutro.

Guarante certificate:





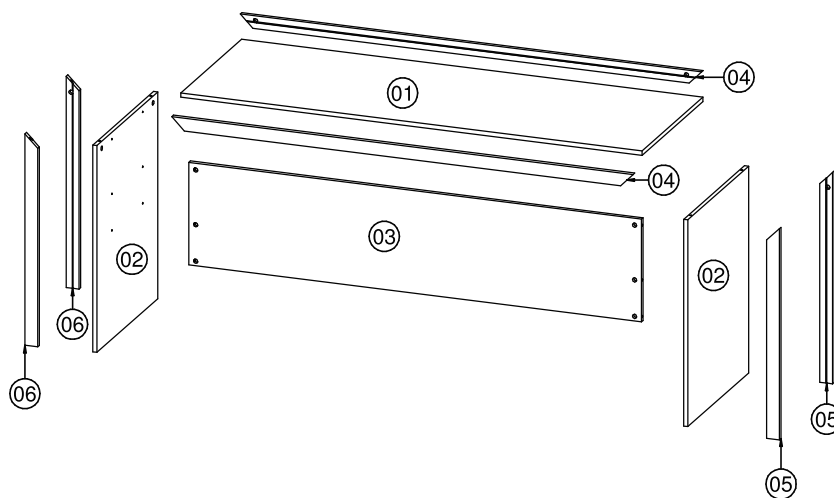

The guarantee of products manufactured by Móveis Videira LTDA covers any defects / manufacturing defects, within the period established by the Consumer Protection Code, in its Article 26, II, which provides for a legal guarantee of ninety (90) days.

Lista de Peças / List of pieces / Lista de piezas

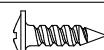
CÓD	DESCRIÇÃO	DESCRIPTION	DESCRIPCIÓN	QTD	M. PRIMA	DIMENSÕES
01	Tampo	Top	Tapa	1	MDP 15mm	1800 x 570 x 15mm
02	Lateral	Side	Lateral	2	MDP 15mm	725 x 570 x 15mm
03	Costa	Back	Revés	1	MDP 15mm	1769 x 360 x 15mm
04	Travessa Frontal	FrontTraverse	Traviesa Frontal	2	MDP 15mm	1800 x 45 x 15mm
05	Travessa Direita	RightTraverse	Traviesa Derecha	2	MDP 15mm	741 x 45 x 15mm
06	Travessa Esquerda	LeftTraverse	Traviesa Izquierda	2	MDP 15mm	741 x 45 x 15mm

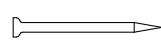

REF DESCRIÇÃO QTD

A	 34 x 7mm Parafuso Minifix	10
B	 3,5 x 14mm CF	40
C	 15 x 12mm Tambor Minifix	10
D	 7 x 5 x 14mm Malhete	08
E	 22 x 17 x 12mm Suporte Angular	20
F	 14 x 4mm Sapata Deslizadora	04
G	 22 x 3mm Prego 10 x 10	04
H	 Tapa Furo	10

Ferramentas | Tools | Herramientas

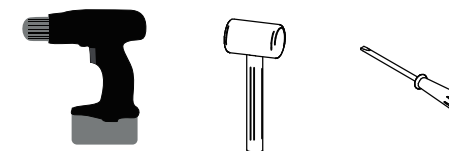

30 min.

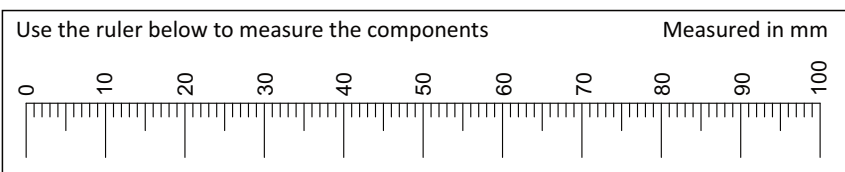

Review: 00
Date: 22/08/2023

