

# ME-4185

## Instruções de Montagem Assembly Instructions Instrucciones de Armado

Acesse Vídeos de Montagens  
Access Mounting Videos  
Acceder a los Vídeos de Montaje  
[www.tecnomobili.ind.br](http://www.tecnomobili.ind.br)

**tecnomobili**

Estrada RSC 453, Km s/n° | Garibaldi | RS  
CEP: 95720-000 | Fone / Fax: 54.3464.2050  
[sac@moveisvideira.com.br](mailto:sac@moveisvideira.com.br)

### Notas Especiais:

**01** -Examine completamente todas as peças do móvel antes de começar o trabalho.

**02** -Recomenda-se montar o móvel conforme este Manual de Montagem.

**03** -É de responsabilidade do montador seguir as instruções do Manual de Montagem, que são fundamentais para garantir a estrutura do móvel.

**04** -Para limpeza, utilizar somente pano úmido e sabão neutro.

### Special notes:

**01** -Check all parts of the unit thoroughly before starting work.

**02** -It is recommended to assemble the furniture according to this Installation Manual.

**03** -It is the responsibility of the assembler to follow the instructions in the Assembly Manual, which are essential to ensure the structure of the furniture.

**04** -For cleaning use only damp cloth and neutral soap.

### Notas especiales:

**01** -Examine completamente todas las piezas del mueble antes de iniciar el trabajo.

**02** -Se recomienda montar el mueble conforme el Manual de Ensamblaje.

**03** -Es de responsabilidad del montador seguir las instrucciones del Manual de Ensamblaje, que son fundamentales para garantizar la estructura del mueble.

**04** -Para limpieza solamente usar trapo húmedo y jabón neutro.

### Guarante certificate:





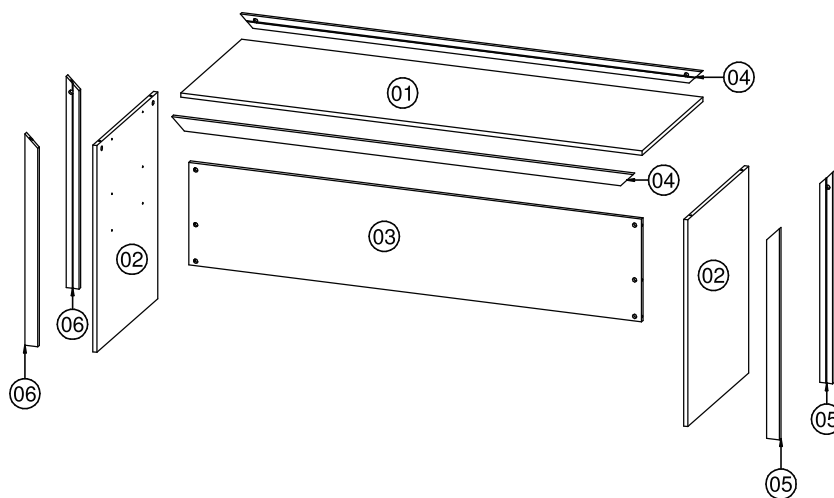

The guarantee of products manufactured by Móveis Videira LTDA covers any defects / manufacturing defects, within the period established by the Consumer Protection Code, in its Article 26, II, which provides for a legal guarantee of ninety (90) days.

### Lista de Peças / List of pieces / Lista de piezas

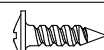
CÓD	DESCRIÇÃO	DESCRIPTION	DESCRIPCIÓN	QTD	M. PRIMA	DIMENSÕES
01	Tampo	Top	Tapa	1	MDP 15mm	1800 x 570 x 15mm
02	Lateral	Side	Lateral	2	MDP 15mm	725 x 570 x 15mm
03	Costa	Back	Revés	1	MDP 15mm	1769 x 360 x 15mm
04	Travessa Frontal	FrontTraverse	Traviesa Frontal	2	MDP 15mm	1800 x 45 x 15mm
05	Travessa Direita	RightTraverse	Traviesa Derecha	2	MDP 15mm	741 x 45 x 15mm
06	Travessa Esquerda	LeftTraverse	Traviesa Izquierda	2	MDP 15mm	741 x 45 x 15mm

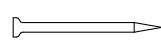

### REF DESCRIÇÃO QTD

A	 34 x 7mm Parafuso Minifix	10
B	 3,5 x 14mm CF	40
C	 15 x 12mm Tambor Minifix	10
D	 7 x 5 x 14mm Malhete	08
E	 22 x 17 x 12mm Suporte Angular	20
F	 14 x 4mm Sapata Deslizadora	04
G	 22 x 3mm Prego 10 x 10	04
H	 Tapa Furo	10

### Ferramentas | Tools | Herramientas

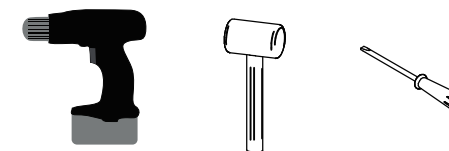

30 min.

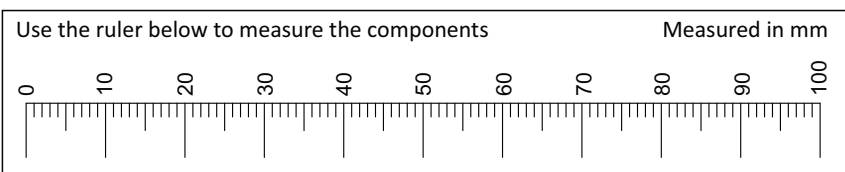

Review: 00  
Date: 22/08/2023



# Agora que você já comprou o seu móvel, ele merece ser montado do jeito certo.

Erros de montagem causam mais de **60%** dos danos em móveis.

## Por que contratar?

Tranquilidade do **início ao fim** da montagem



### PROFISSIONAIS QUALIFICADOS

Especialistas certificados na **MadeiraMadeira Serviços**.



### FERRAMENTAS PROFISSIONAIS

que **protegem** seus móveis.



### AGENDAMENTO EM 24 HORAS

escolha a data e o turno **ideais para** você.



### GARANTIA DE 3 MESES

de cobertura **completa**.

**Mais de 1 MILHÃO DE MONTAGENS**  
★ com avaliação 4.7 ★

#### Mariana S., São Paulo

"Chegaram no horário e montaram tudo rapidamente. Serviço incrível!"



#### Carlos R., Belo Horizonte

"Tentei montar sozinho e foi um desastre. Com a **MadeiraMadeira Serviços** ficou perfeito."



#### Ana P., Rio de Janeiro

"Agendamento ágil e **montagem pontual e perfeita**. Recomendo demais!"



Agende agora pelo  
**QR Code**

Madeira**Madeira** Serviços · Atendimento em todo o Brasil



Escaneie o QRCode