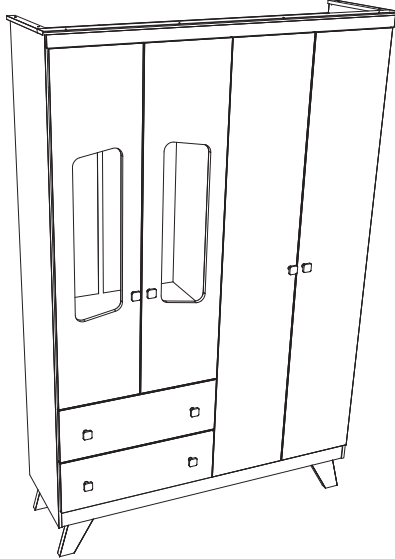
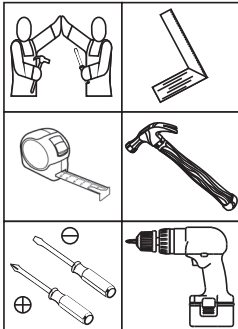

HENNInd. e Com. de Móveis Henn
Mondai - SC - Brasil

☎ +55 49 3674.3500

📧 @moveishenn
www.henn.com.br**INSTRUÇÕES DE
MONTAGEM**INSTRUCCIONES DE MONTAJE
ASSEMBLY INSTRUCTIONS**Quarto de bebê Completo Retro Theo****IE85-190 Branco/Jequitibá HP****Requisitos para montagem
Requisitos para la montaje
Assembly Requirements**

Imagens meramente ilustrativas,
não acompanha o produto.
Imágenes ilustrativas, no incluidas
con el producto.
Illustrative images, not included
with the product.

AVISO

Para limpeza de seu móvel, use uma flanela seca ou umedecida, e não utilize produtos químicos que possam danificar seu produto.

SISTEMA DE MONTAGEM

O sistema de montagem dos produtos, funciona de acordo com a ordem crescente dos números indicados no desenho. Ex: 01, 02, 03, 04... até a conclusão da montagem.

ASSISTÊNCIA TÉCNICA

Para solicitação de Assistência Técnica você consumidor deverá entrar em contato com o Lojista o qual você realizou a compra deste produto e solicitar a assistência técnica das peças avariadas. A garantia abrange todas as peças, partes e componentes que eventualmente venham apresentar defeito de fabricação no prazo de 03 (três) meses, contando a partir da entrega do produto ao consumidor, mediante nota fiscal de compra. Se houver qualquer alteração na estrutura do produto ou ocorrer defeito por negligência do montador/consumidor em relação a instrução de montagem e manuseio, não será fornecido assistência técnica gratuita.

ADVERTENCIA

Para limpieza de su móvil, use una flanela seca o húmeda, y no utilice productos químicos que puedan dañar su producto.

SISTEMA DE MONTAJE

El sistema de montaje de los productos funciona de acuerdo con el orden creciente de los números indicados en el dibujo. Ej.: 01, 02, 03, 04... hasta la conclusión del montaje.

ASISTENCIA TÉCNICA

Para solicitar Asistencia Técnica, el consumidor debe comunicarse con el Comercio que usted realizó la compra de este producto y solicita asistencia técnica para las partes dañadas. La garantía cubre todas las partes, piezas y componentes que eventualmente puedan presentar defecto de fabricación en el plazo de 03 (tres) meses, contados a partir de la entrega del producto al consumidor, mediante factura de compra. Si se produce algún cambio en la estructura del producto o se produce un defecto por negligencia del montador/consumidor en relación con las instrucciones de montaje y manipulación, no se prestará asistencia técnica gratuita.

NOTICE

To clean your furniture, use a dry or wet cloth, and do not use chemicals that may damage your product.

ASSEMBLY SYSTEM

The products' assembly system works according to the increasing order of the indicated numbers. For example: 01, 02, 03, 04 ... to the end of the assembly.

TECHNICAL ASSISTANCE

To request Technical Assistance, the consumer must contact the retailer from whom you purchased this product and request technical assistance for the damaged parts. The warranty covers all parts, parts and components that may eventually present a manufacturing defect within a period of 03 (three) months, counting from the delivery of the product to the consumer, by means of a purchase invoice. If there is any change in the structure of the product or defect occurs due to negligence of the assembler/consumer in relation to the assembly and handling instruction, free technical assistance will not be provided.

ACESSÓRIOS | ACCESORIOS | ACCESSORIES

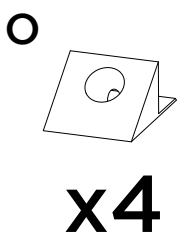
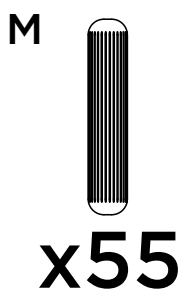
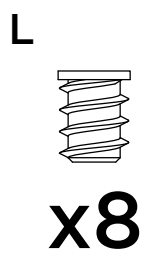
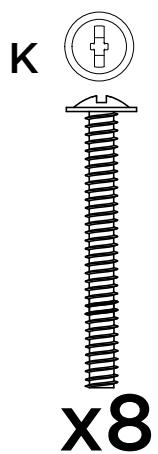
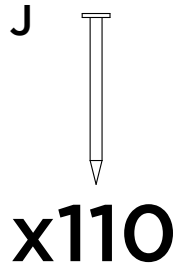
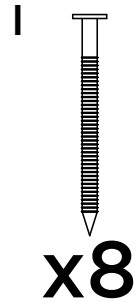
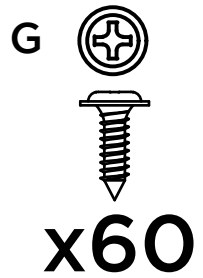
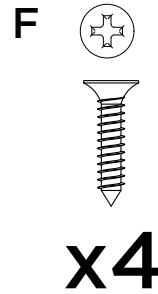
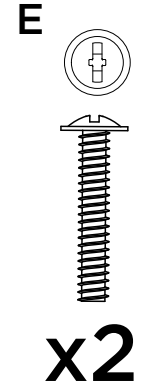
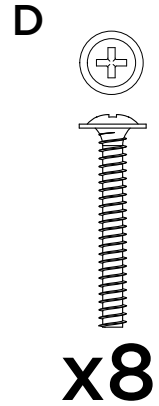
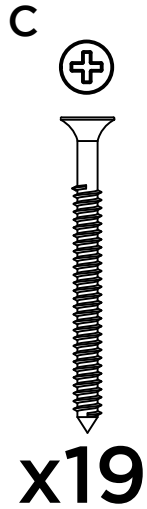
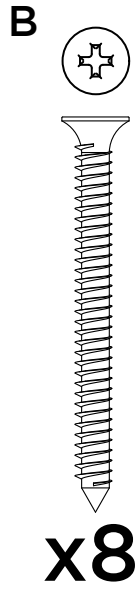
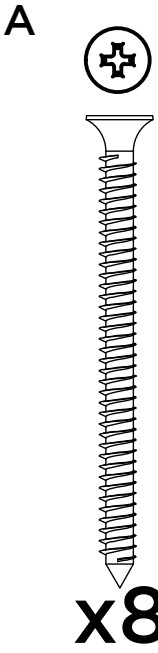

Parafusos em escala
Tornillos escalados
Scaled screws **1:1**

ACESSÓRIOS | ACCESORIOS | ACCESSORIES

P



x2

Q

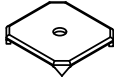

x16

R



x16

S



x8

T

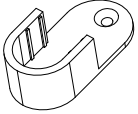

x2

U

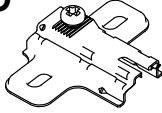

x12

V

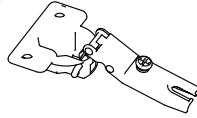

x12

W

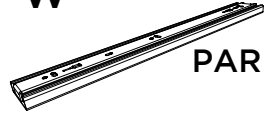

PAR

x2

X



x1

Y

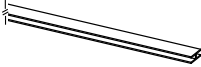

x2

Z

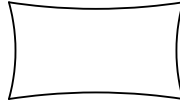

x1

AA

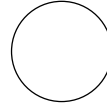

x26

AB

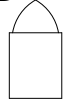

x3

AC



x1

AD

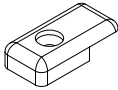

x12

AE



x1

AF

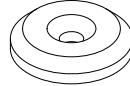

x4

AG

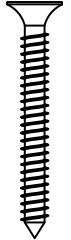

x8

AH

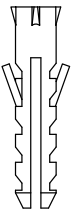

x1

AI

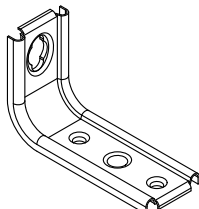

x1

AJ

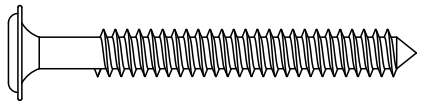

x1

Parafusos em escala
Tornillos escalados
Scaled screws

LISTA DE PEÇAS | LISTA DE PIEZAS | LIST OF PIECES ITM/I125-

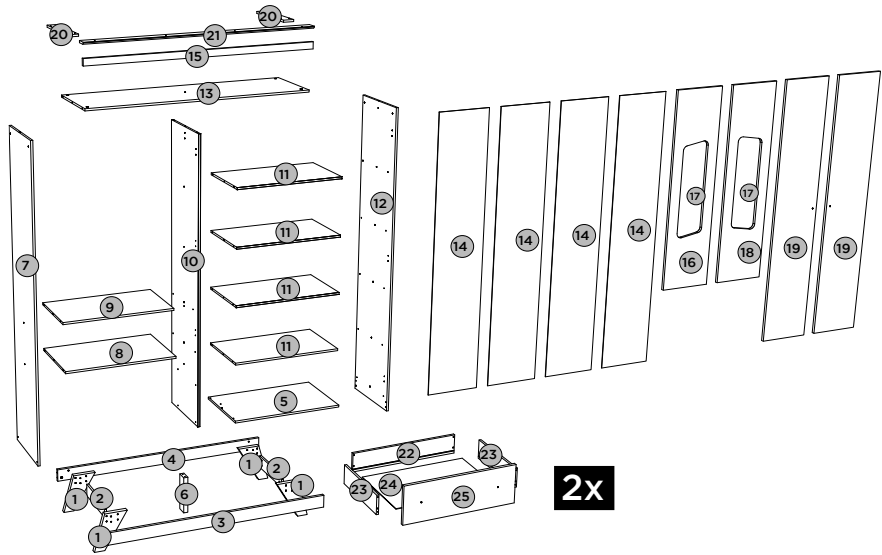

Item	Caixa Caja Box	Qty Ctd Qty	Descrição Descripción Description	Dimensões (mm) Dimensiones (mm) Dimensions (mm)		
				Comprimento Largo Length	Largura Ancho Width	Espessura Grosor Thickness
1	1/2	4	PÉ PIE FOOT	223	191	25
2	1/2	2	TRAVESSA DO RODAPÉ TRAVESAÑO DE PIE DE PÁGINA FOOTER CROSSPIECE	294	73	12
3	1/2	1	RODAPÉ FRONTAL PIE DE PÁGINA FRONTAL FRONT FOOTER	1260	73	15
4	2/2	1	RODAPÉ TRASEIRO PIE DE PÁGINA POSTERIOR REAR FOOTER	1260	73	15
5	1/2	1	BASE BASE BASE	636	380	12
6	1/2	1	PÉ CENTRAL PIE CENTRAL CENTER FOOT	223	60	25
7	1/2	1	LATERAL ESQUERDA LADO IZQUIERDO LEFT SIDE	1835	380	12
8	1/2	1	TAMPO DAS GAVETAS PARTE SUPERIOR DEL CAJÓN DRAWER TOP	624	380	12
9=11	1/2	1	PRATELEIRA ESTANTE SHELF	624	350	12
10	1/2	1	DIVISÃO DIVISIÓN DIVISION	1703	380	12
11=9	1/2	4	PRATELEIRA ESTANTE SHELF	624	350	12
12	1/2	1	LATERAL DIREITA LADO DERECHO RIGHT SIDE	1835	380	12
13	1/2	1	TAMPO CUBRIR COVER	1260	380	12
14	1/2	4	FUNDO FONDO BOTTOM	1727	319	3
15	1/2	1	CHAPÉU SOMBRERO HAT	1282	40	15
16	2/2	1	PORTA ESQUERDA PUERTA IZQUIERDA LEFT DOOR	1269	315	15
17	2/2	2	VIDRO VIDRIO GLASS	650	215	3
18	2/2	1	PORTA DIREITA PUERTA DERECHA RIGHT DOOR	1269	315	15
19	2/2	2	PORTA MAIOR GRAN PUERTA GREAT DOOR	1717	315	15
20	1/2	2	MOLDURA LATERAL MARCO LATERAL SIDE FRAME	344	30	12
21	1/2	1	MOLDURA FRONTAL MARCO FRONTAL FRONT FRAME	1308	60	12
22	1/2	2	RIPA DE TRÁS PORTÁTIL TRASERO BACK LAPTOP	604	110	12
23	1/2	4	LADO DE GAVETA LADO DEL CAJÓN DRAWER SIDE	350	110	12
24	1/2	2	FUNDO DE GAVETA FONDO DE CAJÓN DRAWER BOTTOM	591	361	3
25	2/2	2	FRENTE DE GAVETA FRENTE DE CAJÓN DRAWER FRONT	634	220	15







PASSO 1

ITM/I125-

PEÇAS REQUERIDAS

1	PÉ	x4
2	TRAVESSA DO RODAPÉ	x2
3	RODAPÉ FRONTAL	x1
4	RODAPÉ TRASEIRO	x1
6	PÉ CENTRAL	x1

ACESSÓRIOS REQUERIDOS

I		04
L		08
M		05
R		12
AE		01
AF		04

FERRAMENTAS NECESSÁRIAS

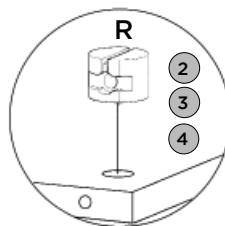
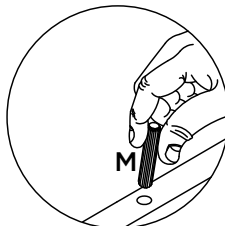
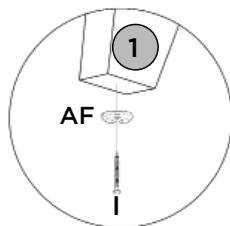
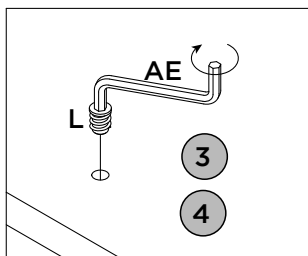
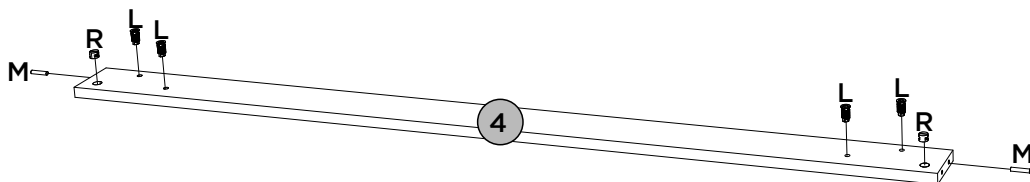
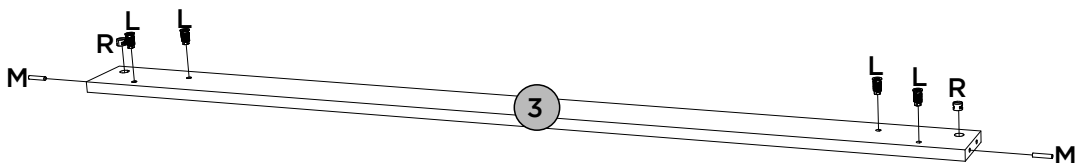
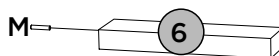
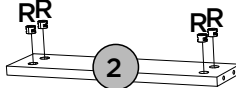
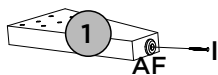
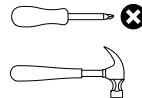

PEÇAS REQUERIDAS

5	BASE	x1
8	TAMPO DAS GAVETAS	x1
9=11	PRATELEIRA	x5

ACESSÓRIOS REQUERIDOS

M		26
---	---	----

FERRAMENTAS NECESSÁRIAS

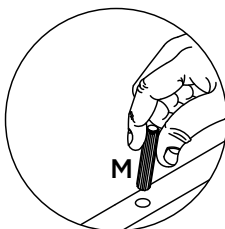
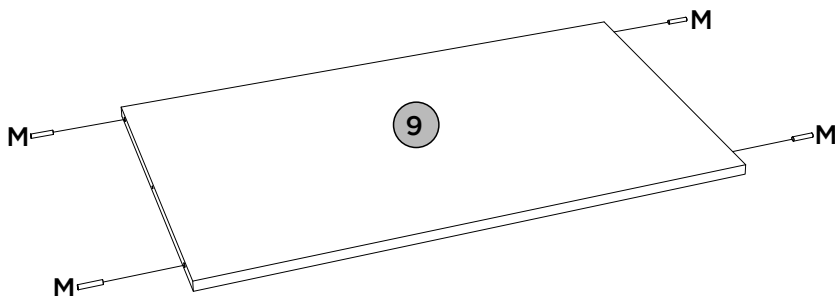
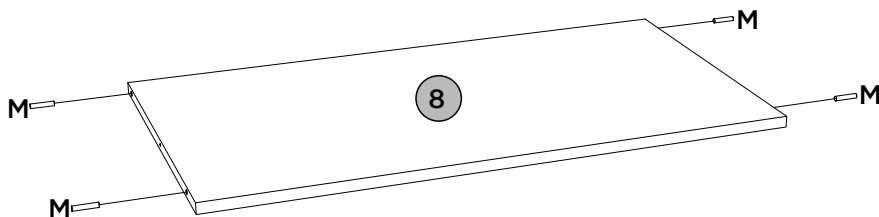
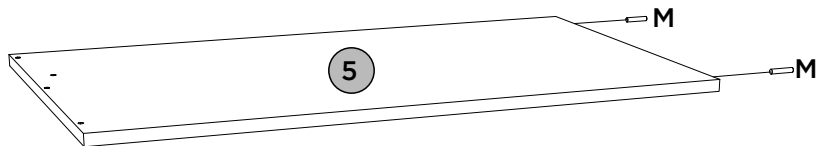
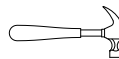

PEÇAS REQUERIDAS

7	LATERAL ESQUERDA	x1
10	DIVISÃO	x1

ACESSÓRIOS REQUERIDOS

G		14
H		16
M		05
T		02
U		07
W		02

FERRAMENTAS NECESSÁRIAS

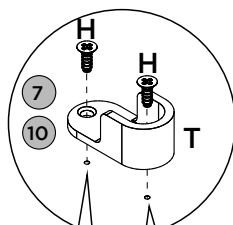
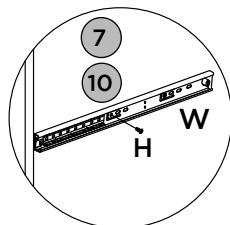
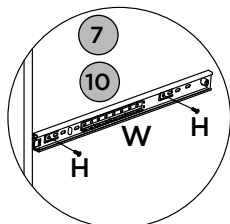
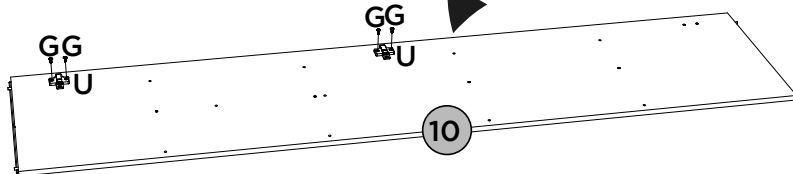
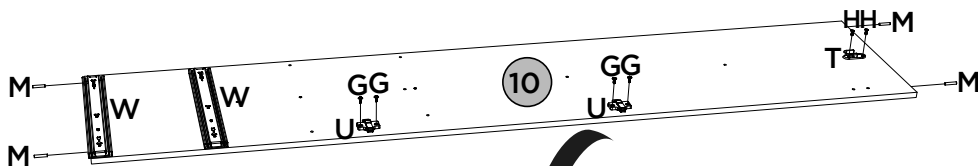
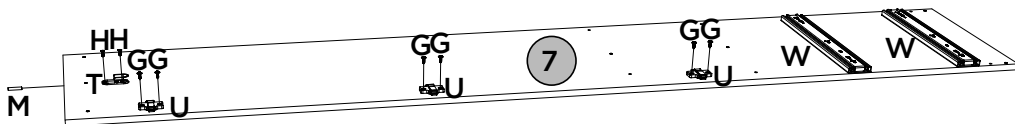
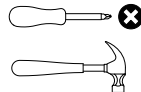

**Observe:
Furos
pré-marcados**

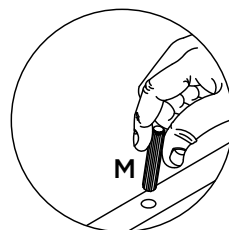
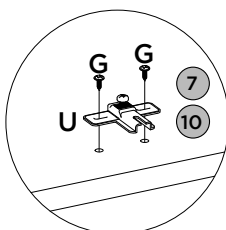





PASSO 4

ITM/I125-

PEÇAS REQUERIDAS

12	LATERAL DIREITA	x1
13	TAMPO	x1

ACESSÓRIOS REQUERIDOS

G		06
M		03
R		04
U		03

FERRAMENTAS NECESSÁRIAS

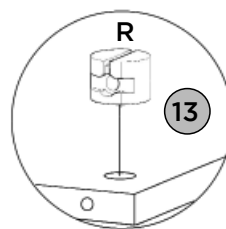
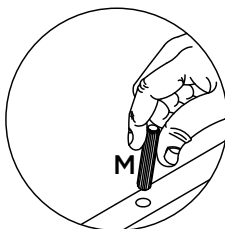
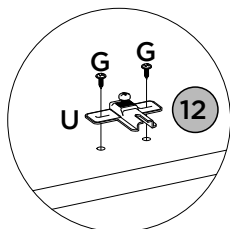
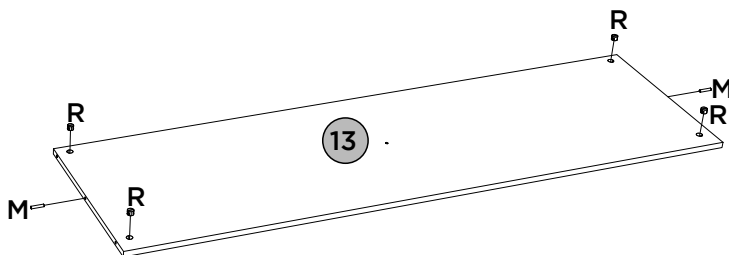
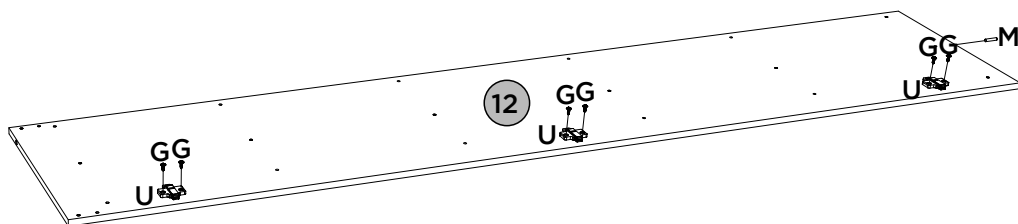
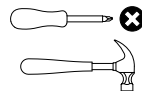

PASSO 5

ITM/1125-

PEÇAS REQUERIDAS

1	PÉ	x4
2	TRAVESSA DO RODAPÉ	x2

ACESSÓRIOS REQUERIDOS



FERRAMENTAS NECESSÁRIAS

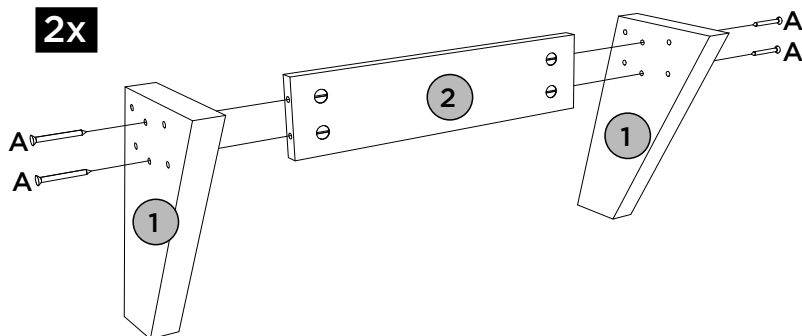
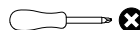

PASSO 6

PEÇAS REQUERIDAS

3	RODAPÉ FRONTAL	x1
4	RODAPÉ TRASEIRO	x1

ACESSÓRIOS REQUERIDOS





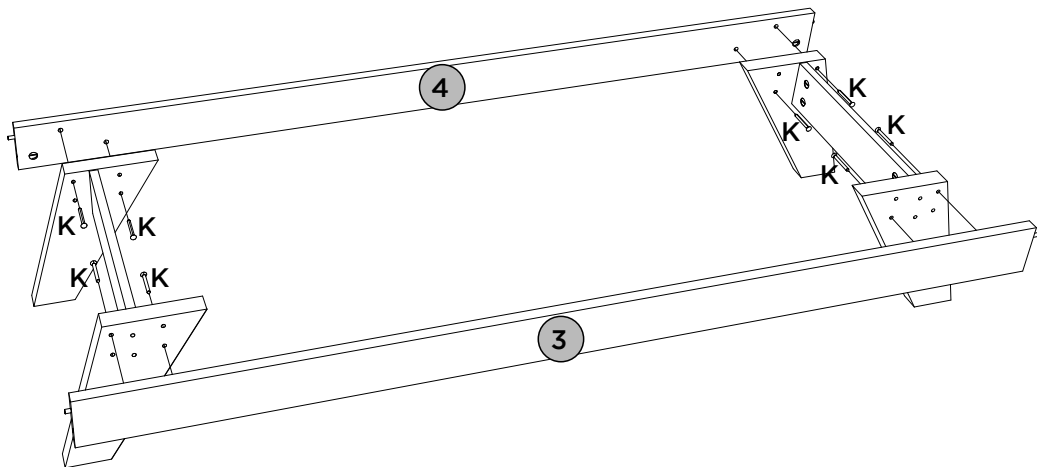
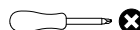

FERRAMENTAS NECESSÁRIAS



PEÇAS REQUERIDAS

5	BASE	x1
6	PÉ CENTRAL	x1
7	LATERAL ESQUERDA	x1

ACESSÓRIOS REQUERIDOS

B		02
C		01
G		04
N		02

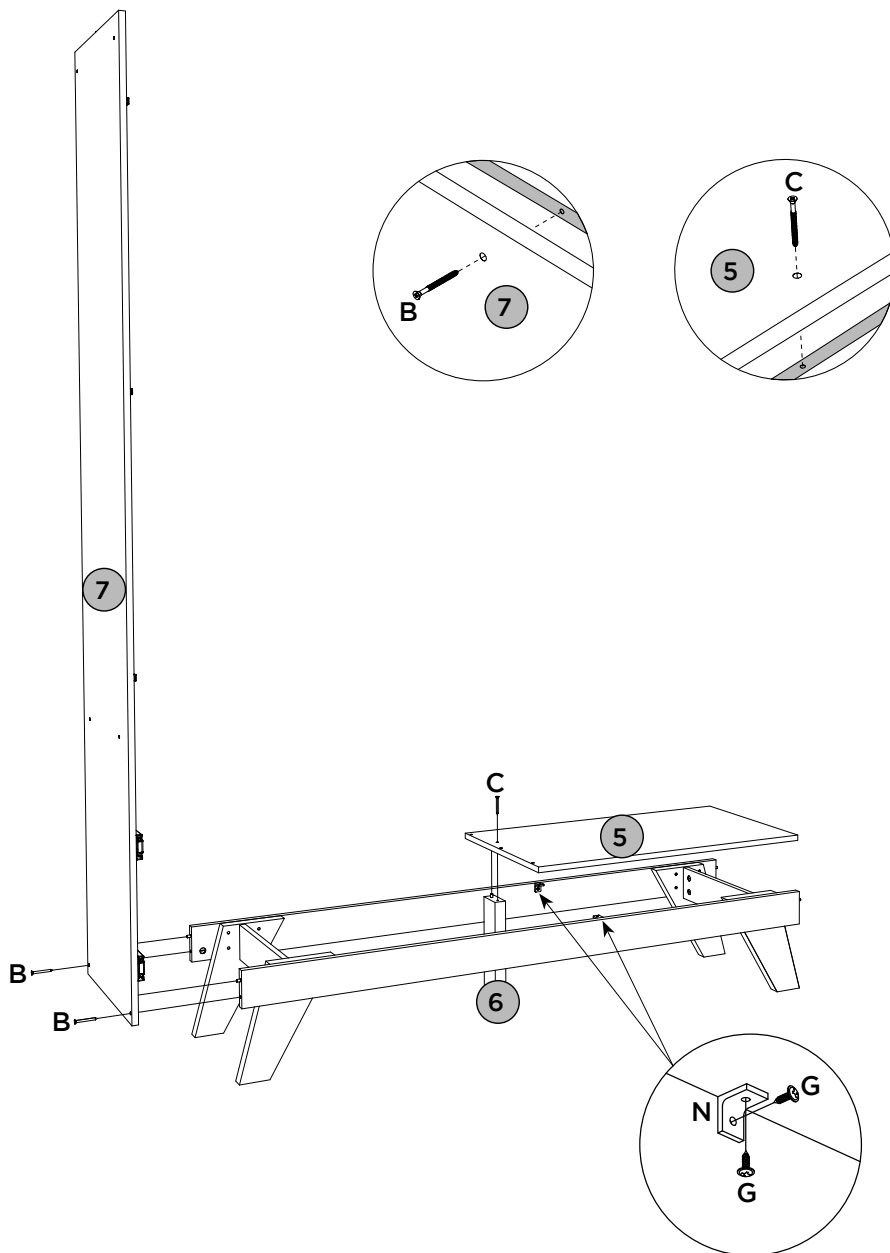
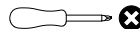
FERRAMENTAS NECESSÁRIAS

PEÇAS REQUERIDAS

8	TAMPO DAS GAVETAS	x1
9=11	PRATELEIRA	x1
10	DIVISÃO	x1

ACESSÓRIOS REQUERIDOS

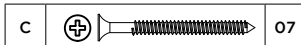



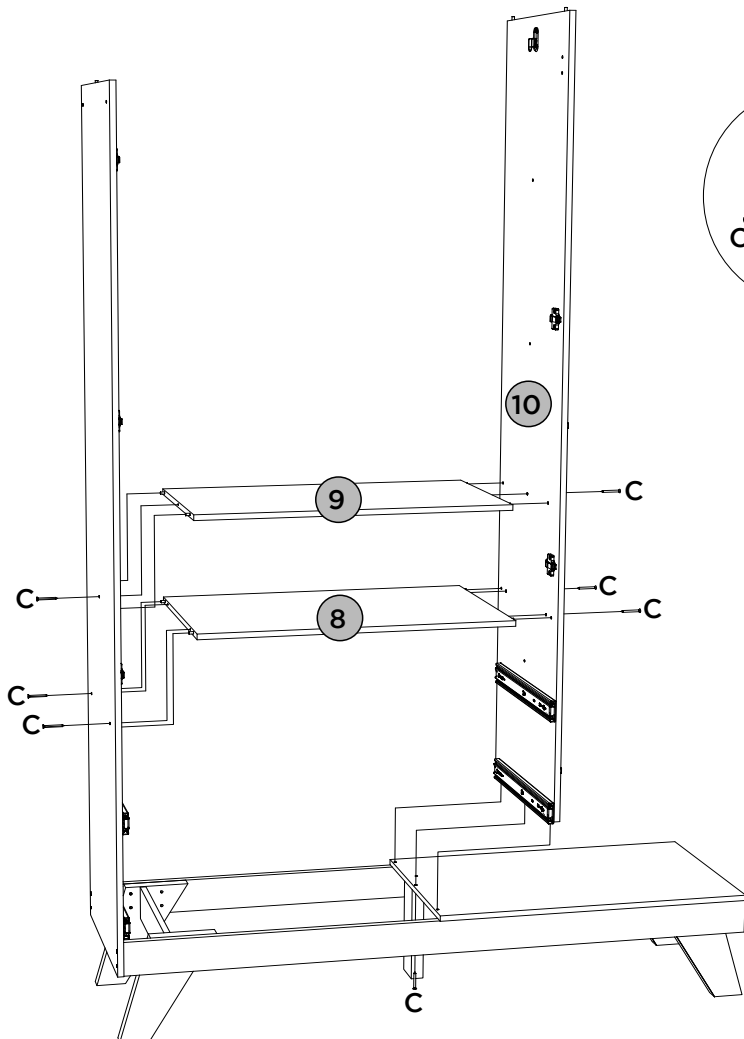
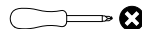

FERRAMENTAS NECESSÁRIAS



PEÇAS REQUERIDAS

11=9	PRATELERIA	x4
12	LATERAL DIREITA	x1
13	TAMPO	x1

ACESSÓRIOS REQUERIDOS

B			06
C			11

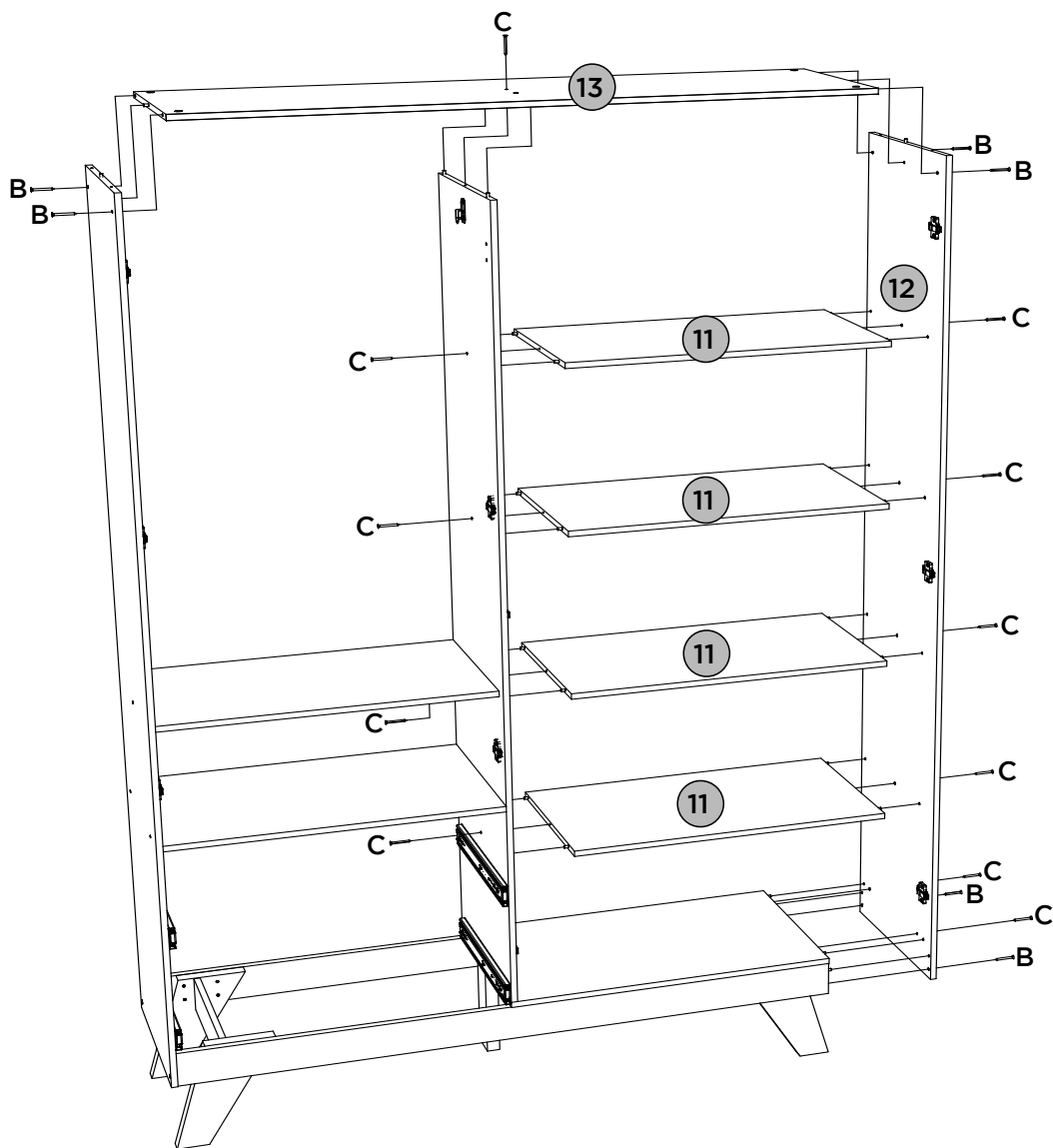
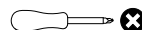

FERRAMENTAS NECESSÁRIAS



PEÇAS REQUERIDAS

14	FUNDO	x4
15	CHAPÉU	x1

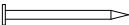
ACESSÓRIOS REQUERIDOS

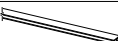
G		10
J		110
N		05
Q		16
Y		02

FERRAMENTAS NECESSÁRIAS

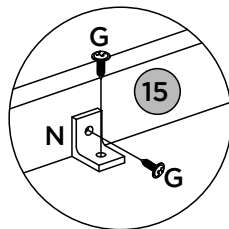
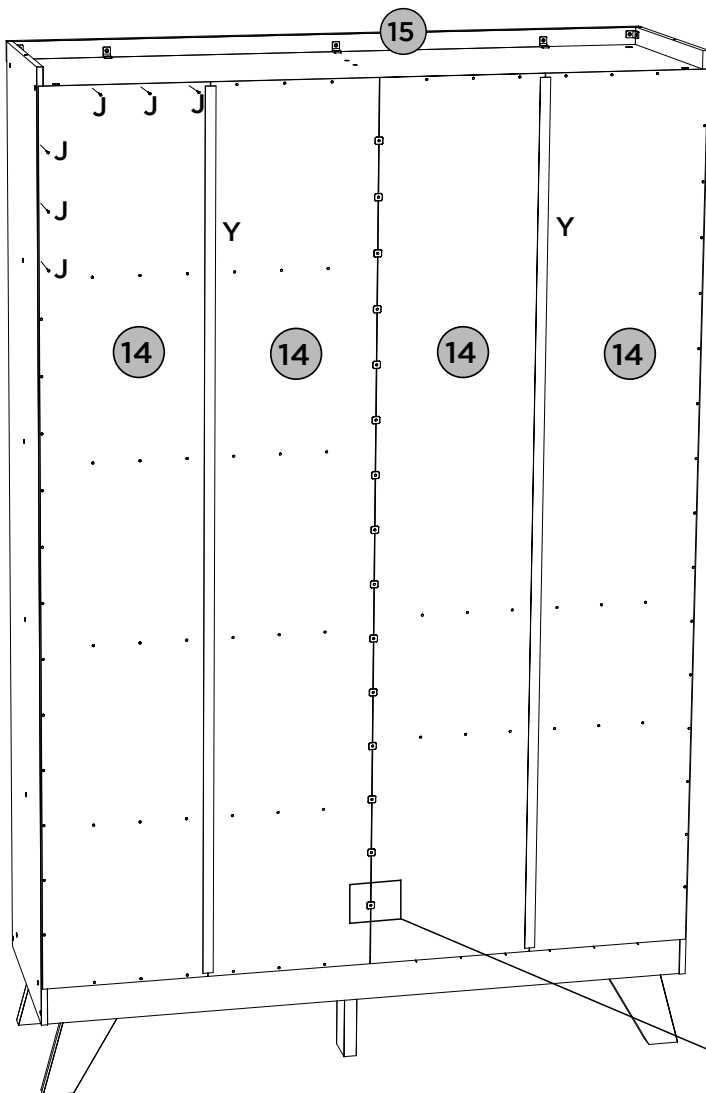
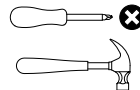

Fixar os pregos a uma distância de 120mm de um para outro.

Fijar las uñas a un distancia de 120mm uno a otro.

Fix the nails at a distance of 120mm from one to the other

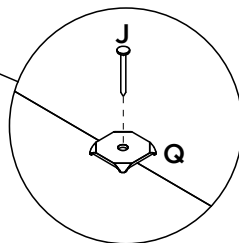

PEÇAS REQUERIDAS

16	PORTA ESQUERDA	x1
17	VIDRO	x2
18	PORTA DIREITA	x1
19	PORTA MAIOR	x2

ACESSÓRIOS REQUERIDOS

D		04
G		24
H		12
S		04
V		12
AD		12

FERRAMENTAS NECESSÁRIAS

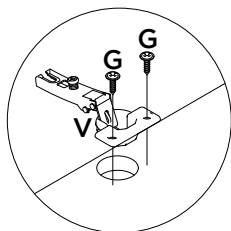
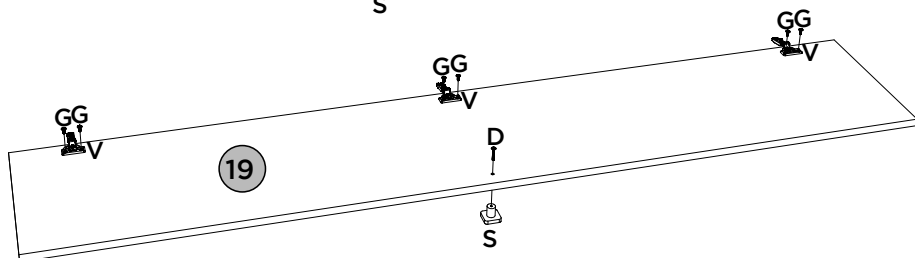
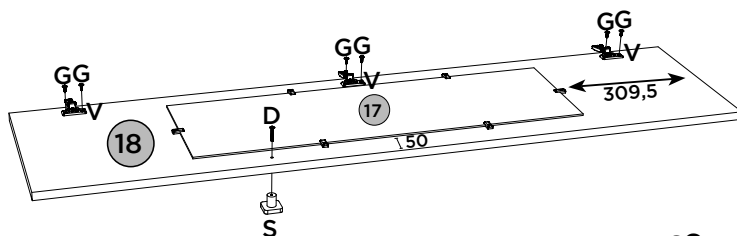
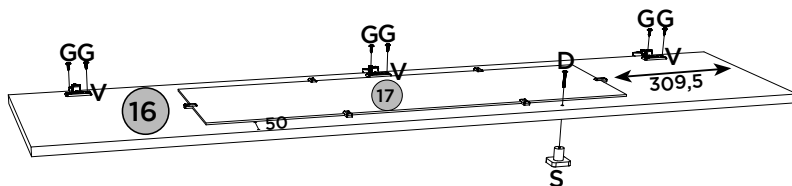
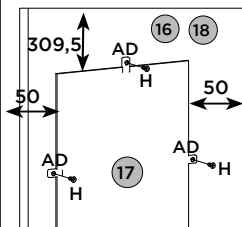
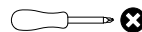

Vídeo: Instalar e regular Dobradiças





Vídeo: Instale y ajuste las bisagras

Vídeo: Install and adjust hinges

PEÇAS REQUERIDAS

16	PORTA ESQUERDA	x1
18	PORTA DIREITA	x1
19	PORTA MAIOR	x2
20	MOLDURA LATERAL	x2
21	MOLDURA FRONTAL	x1

ACESSÓRIOS REQUERIDOS

AG		08
E		02
P		02
U		02
X		01

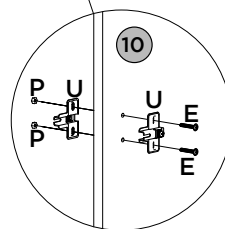
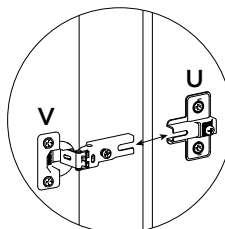
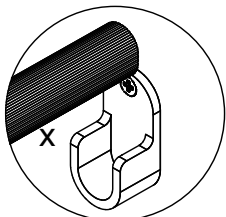
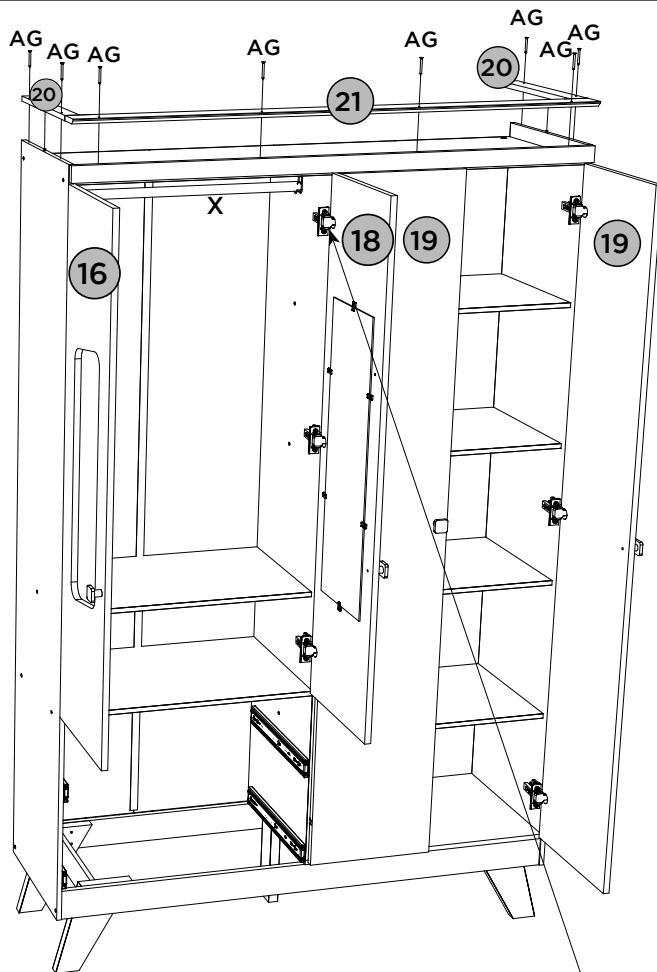
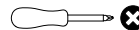
FERRAMENTAS NECESSÁRIAS





PASSO 13

ITM/I125-

PEÇAS REQUERIDAS

23	LADO DE GAVETA	x4
25	FRENTE DE GAVETA	x2

ACESSÓRIOS REQUERIDOS

D		04
M		16
S		04
Z		

FERRAMENTAS NECESSÁRIAS

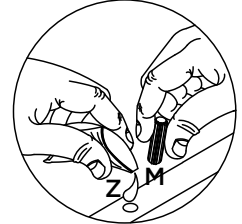
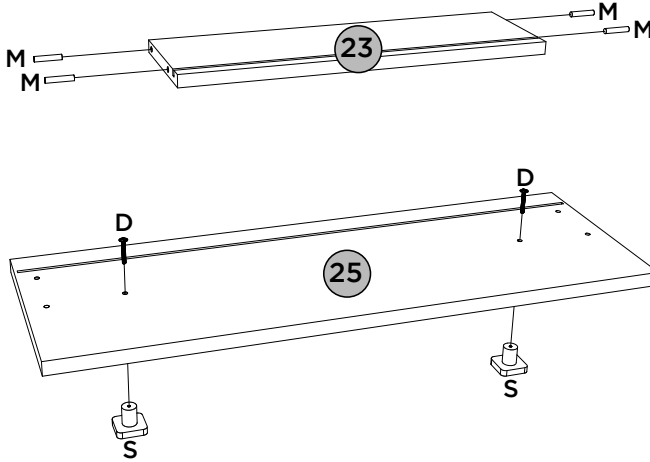
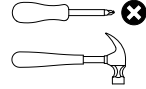

PASSO 14

PEÇAS REQUERIDAS

22	RIPA DE TRÁS	x2
23	LADO DE GAVETA	x4

ACESSÓRIOS REQUERIDOS

Z		
---	---	--

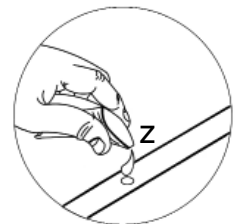
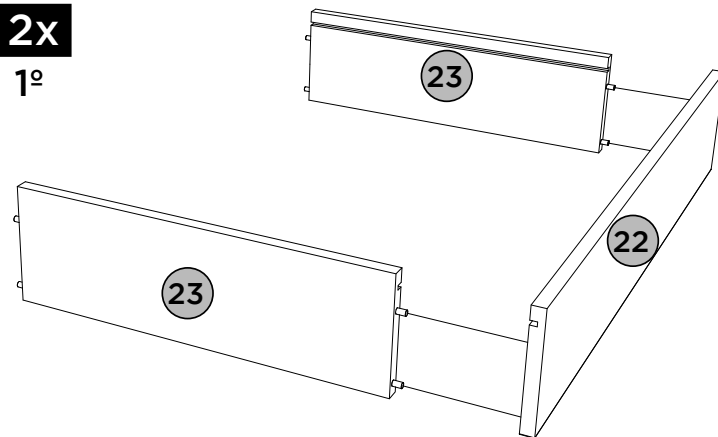



2x
1º

PEÇAS REQUERIDAS

24	FUNDO DE GAVETA	x2
25	FRENTE DE GAVETA	x2

ACESSÓRIOS REQUERIDOS

I		04
Z		

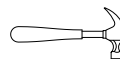
FERRAMENTAS NECESSÁRIAS

2x

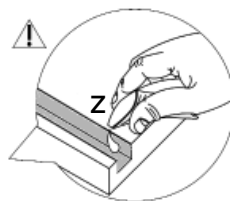
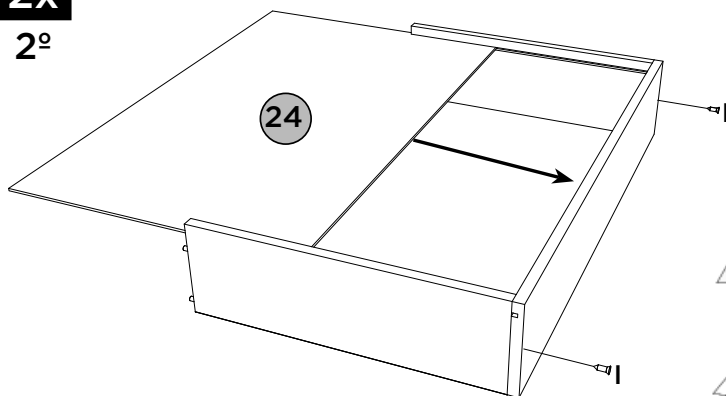



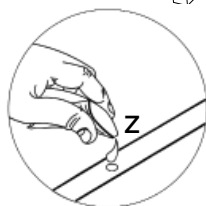
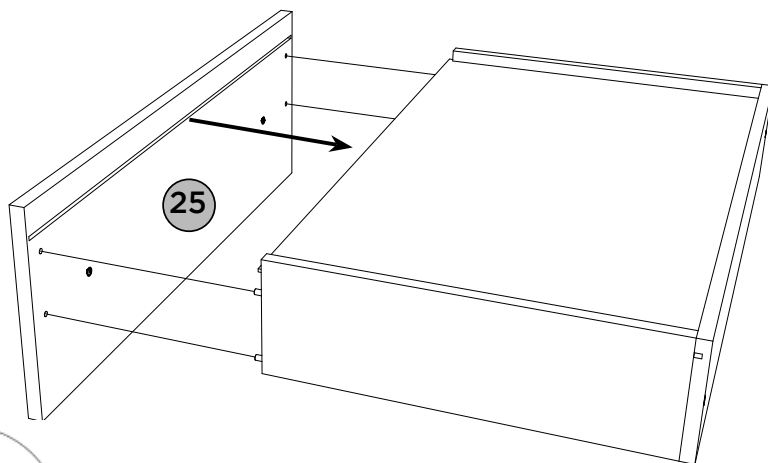

2º

2x

3º



ACESSÓRIOS REQUERIDOS

F			04
H			20
N			04
O			04
W			02

FERRAMENTAS NECESSÁRIAS

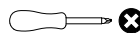

2x

4º

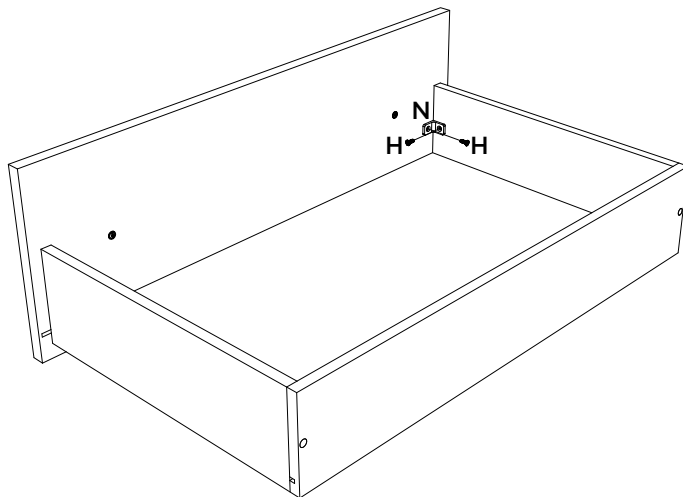





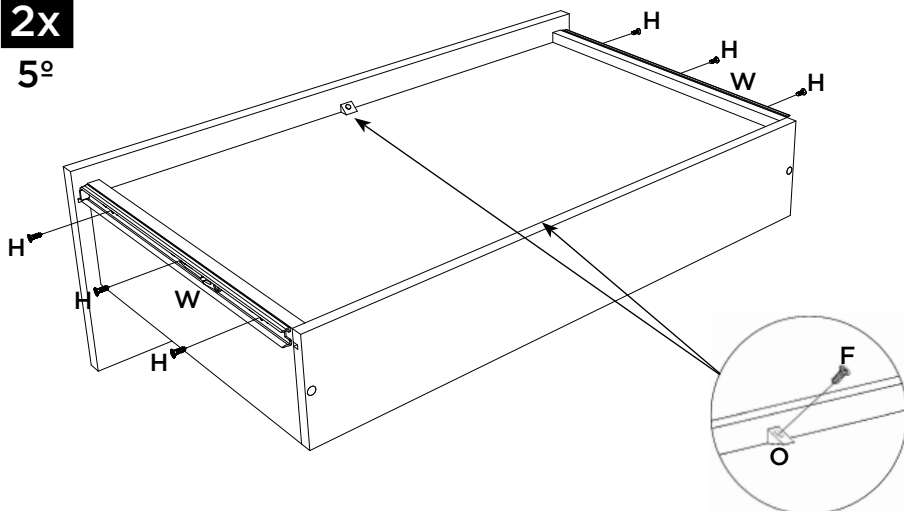

2x

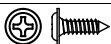
5º



ACESSÓRIOS REQUERIDOS
FERRAMENTAS NECESSÁRIAS

G		02			
AA		26	AH		01
AB		03	AI		01
AC		01	AJ		01

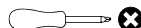

Imprescindível a fixação do produto na parede, a não colocação destas ferragens para fixação (G, AH, AI e AJ), poderá permitir que o produto vire, causando acidente.

Es imprescindible la fijación del producto en la pared, la no colocación de estos herrajes para fijación (G, AH, AI y AJ), podrá permitir que el El producto se vuelva, causando accidente.

Indispensable to fix the product on the wall, not the placement of these attachment fittings (G, AH, AI and AJ) may allow the product to turn, causing an accident.

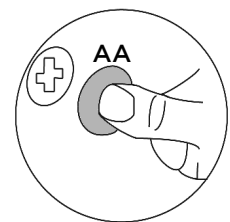
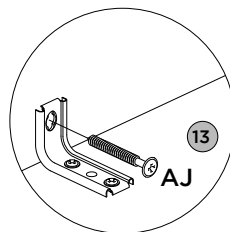
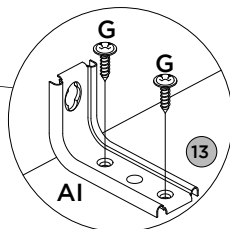
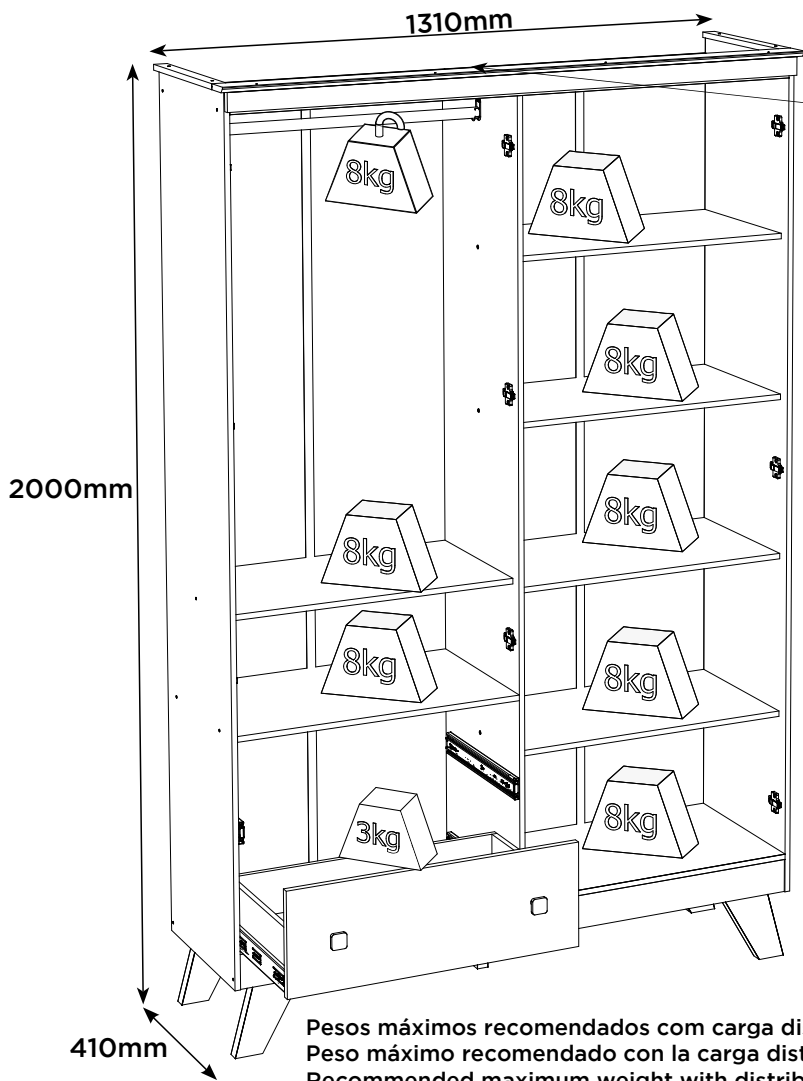

PERFECT CORRECTION
CORRECCIÓN PERFECTA

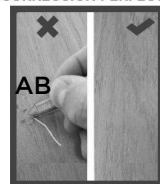

Pesos máximos recomendados com carga distribuída
Peso máximo recomendado con la carga distribuida
Recommended maximum weight with distributed load.

Produto Concluído
Producto terminado
Finished Product

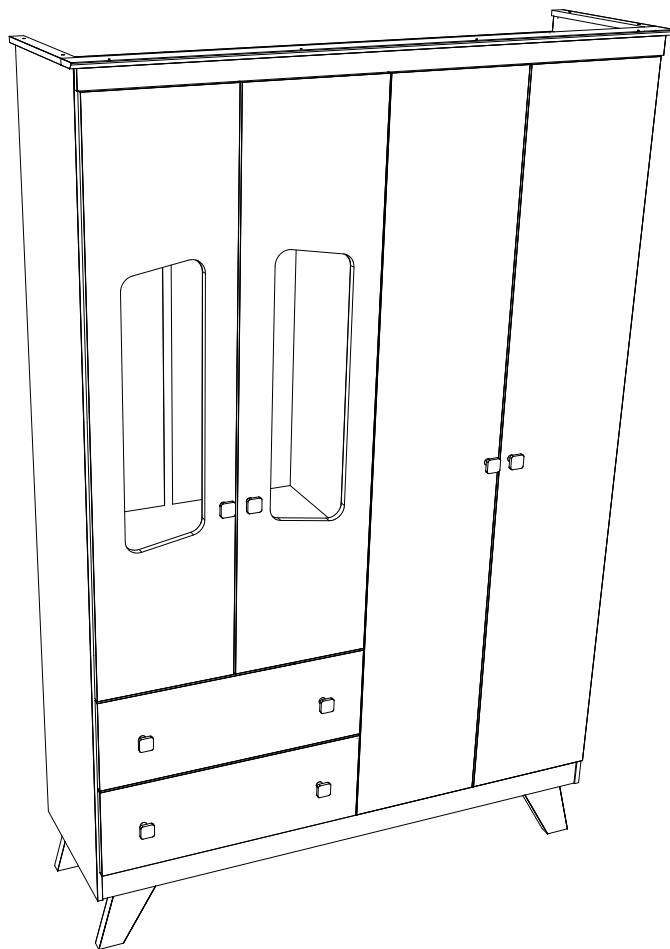

HENNInd. e Com. de Móveis Henn
Mondai - SC - Brasil

☎ +55 49 3674.3500

📷 @moveishenn
www.henn.com.br**INSTRUÇÕES DE
MONTAGEM**INSTRUCCIONES DE MONTAJE
ASSEMBLY INSTRUCTIONS**Berço Mini Cama Confete**
Cuna Mini Cama Confete | Crib Confete

123-190 Branco/Jequitibá HP

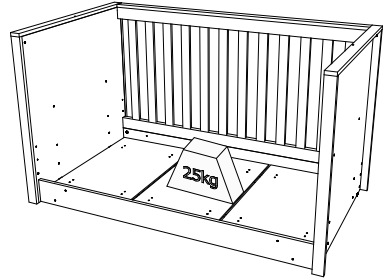
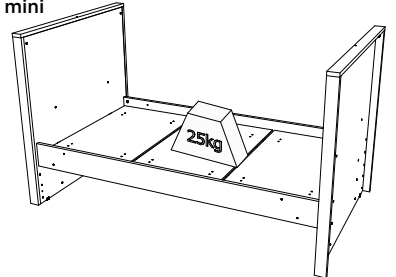
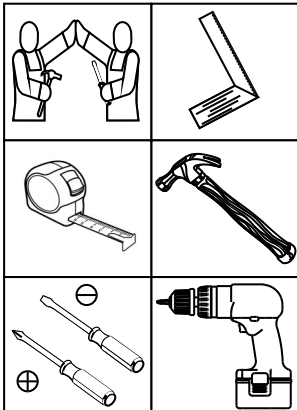
Opção Berço
Opción de cuna
Crib OptionOpção Montessoriano
Opción Montessori
Montessoriano OptionOpção Mini Cama
Opción de cama mini
Mini Bed OptionPesos máximos recomendados com carga distribuída
Peso máximo recomendado con la carga distribuida
Recommended maximum weight with distributed load.**Requisitos para montagem**
Requisitos para la montaje
Assembly RequirementsImagens meramente ilustrativas,
não acompanha o produto.
Imágenes ilustrativas, no incluidas
con el producto.
Illustrative images, not included
with the product.**AVISO**

Para limpeza de seu móvel, use uma flanela seca ou umedecida, e não utilize produtos químicos que possam danificar seu produto.

SISTEMA DE MONTAGEM

O sistema de montagem dos produtos, funciona de acordo com a ordem crescente dos números indicados no desenho. Ex: 01, 02, 03, 04... até a conclusão da montagem.

ASSISTÊNCIA TÉCNICA

Para solicitação de Assistência Técnica você consumidor deverá entrar em contato com o Lojista a qual você realizou a compra deste produto e solicitar a assistência técnica das peças avariadas. A garantia abrange todas as peças, partes e componentes que eventualmente venham apresentar defeito de fabricação no prazo de 03 (três) meses, contando a partir da entrega do produto ao consumidor, mediante nota fiscal de compra. Se houver qualquer alteração na estrutura do produto ou ocorrer defeito por negligência do montador/consumidor em relação a instrução de montagem e manuseio, não será fornecido assistência técnica gratuita.

ADVERTENCIA

Para limpieza de su móvil, use una flanela seca o húmeda, y no utilice productos químicos que puedan dañar su producto.

SISTEMA DE MONTAJE

El sistema de montaje de los productos funciona de acuerdo con el orden creciente de los números indicados en el dibujo. Ej.: 01, 02, 03, 04... hasta la conclusión del montaje.

ASSISTENCIA TÉCNICA

Para solicitar Asistencia Técnica, el consumidor debe comunicarse con el Comercio que usted realizó la compra de este producto y solicita asistencia técnica para las partes dañadas. La garantía cubre todas las partes, piezas y componentes que eventualmente puedan presentar defecto de fabricación en el plazo de 03 (tres) meses, contados a partir de la entrega del producto al consumidor, mediante factura de compra. Si se produce algún cambio en la estructura del producto o se produce un defecto por negligencia del montador/consumidor en relación con las instrucciones de montaje y manipulación, no se prestará asistencia técnica gratuita.

NOTICE

To clean your furniture, use a dry or wet cloth, and do not use chemicals that may damage your product.

ASSEMBLY SYSTEM

The products' assembly system works according to the increasing order of the indicated numbers. For example: 01, 02, 03, 04... to the end of the assembly.

TECHNICAL ASSISTANCE

To request Technical Assistance, the consumer must contact the retailer from whom you purchased this product and request technical assistance for the damaged parts. The warranty covers all parts, parts and components that may eventually present a manufacturing defect within a period of 03 (three) months, counting from the delivery of the product to the consumer, by means of a purchase invoice. If there is any change in the structure of the product or defect occurs due to negligence of the assembler/consumer in relation to the assembly and handling instruction, free technical assistance will not be provided.

IMPORTANTE LER COM ATENÇÃO E GUARDAR PARA EVENTUAIS CONSULTAS

I) **Advertências:** Não posicionar ou utilizar o produto perto de chama aberta e outras fontes de calor, tais como aquecedores elétricos, aquecedores a gás ou outras fontes, pois o material é inflamável.

II) Não utilize o berço se alguma parte estiver quebrada, rasgada ou faltando. Utilizar somente peças de reposição recomendadas pelo fabricante.

III) Não deixe nenhum objeto dentro ou próximo ao berço que possa servir de ponto de apoio ou ofereça risco de sufocação, engasgamento ou estrangulamento, como, por exemplo, cordas, cordões de persianas/cortina, protetores, almofadas, brinquedos, fios e cabos de aparelhos elétricos.

IV) Nunca utilizar mais de um colchão no berço.

V) Crianças pequenas não podem brincar, sem vigilância, nas proximidades de um berço.

VI) **Atenção:** quando a criança for capaz de escalar o berço, ele não pode mais ser utilizado por essa criança, pois este berço foi construído para uso por crianças com capacidade motora para sentar-se, ajoelhar-se e/ou levantar-se sozinhas, porém que ainda não sejam capazes de escalar o berço.

VII) Para berços com mais de uma função, não sujeita à regulamentação: Este produto atende à regulamentação para berços infantis, não sendo as suas demais funções sujeitas à regulamentação.

VIII) Este berço não pode ser alterado, seja em sua estrutura ou em seus adornos, pois riscos à segurança da criança podem ser gerados.

IX) O comprimento e a largura do colchão utilizado com o berço devem atender as especificações deste Manual.

I) **Orientações:** A Sociedade Brasileira de Pediatria orienta colocar o bebê para dormir de barriga para cima, pois diminui em 70% o risco de morte súbita. Recomendamos conversar com o pediatra de seu filho para maiores informações.

II) Só utilize o berço quando estiver totalmente montado conforme as orientações do Manual de Instruções e após certificar que seus sistemas de travamento estão devidamente acionados.

III) O Berço deve ser colocado sobre um piso horizontal.

IV) Para berços com altura da base ajustável: A posição mais baixa é a mais segura e a base deve ser sempre utilizada nessa posição tão logo o bebê tenha idade suficiente para sentar-se.

V) Quando existirem dispositivos de apoio destacáveis para apoiar a base do berço acima da sua posição mais baixa: Antes que o berço seja utilizado na sua posição mais baixa, devem ser removidos os dispositivos usados para apoiar a base em posições mais altas.

VI) As conexões de montagem devem ser sempre apertadas adequadamente e verificadas regularmente, ao longo do uso do berço, e reapertadas conforme necessário.

VII) Caso alguma parte do berço quebre ou apresente defeito, deve-se procurar assistência técnica especializada e não serem realizados consertos caseiros.

VIII) Orientações para a espessura do colchão, que podem ser dadas pelas seguintes formas:

a) O comprimento e a largura do colchão utilizado com o berço devem ser tais que nunca seja possível a formação de espaço maior que 30mm entre as laterais ou extremidades e o colchão.

b) A espessura do colchão deve ser tal que a altura interna (da superfície do colchão até a borda superior da armação do berço) seja de pelo menos 480mm na posição mais baixa da base do berço e pelo menos 180mm na posição mais elevada da base do berço.

c) Quando for utilizada uma marcação no berço para indicar a espessura máxima do colchão: A marcação no berço indica a espessura máxima do colchão a ser utilizado com o berço.

IX) **Recomendação sobre o tamanho mínimo de colchão a ser utilizado com o berço.**

Para o Berço Mini Cama Confete, recomenda-se o uso de colchão de 1,30 m \pm 0,5 cm de comprimento, 70 cm \pm 0,5 cm de largura e 12 cm \pm 0,5 cm de altura, com densidade mínima de

IMPORTANTE LEER CON ATENCIÓN Y GUARDAR PARA EVENTUALES CONSULTAS

I) **Advertencias:** No colocar o utilizar el producto cerca de llama abierta y otras fuentes de calor, tales como calentadores eléctricos, calentadores de gas u otras fuentes, ya que el material es inflamable.

II) No utilice la cuna si alguna parte está rota, rasgada o faltada. Utilice sólo piezas de repuesto recomendadas por el fabricante.

III) No deje ningún objeto dentro o cerca de la cuna que pueda servir de punto de apoyo o ofrezca riesgo de sofocación, engaño o estrangulamiento, como por ejemplo cuerdas, cordones de persianas / cortinas, protectores, cojines, juguetes, hilos y cables de aparatos eléctricos.

IV) Nunca utilizar más de un colchón en la cuna.

V) Los niños pequeños no pueden jugar, sin vigilancia, en las proximidades de una cuna.

VI) Atención: cuando el niño es capaz de escalar la cuna, ya no puede ser utilizado por ese niño, pues esta cuna fue construida para uso por niños con capacidad motora para sentarse, arrodillarse y / o levantarse pero que todavía no son capaces de escalar la cuna.

VII) Para cunas con más de una función, no sujeta a la reglamentación: Este producto atiende a la reglamentación para cunas infantiles, no siendo sus demás funciones sujetas a la reglamentación.

VIII) Esta cuna no puede ser alterada, sea en su estructura o en sus adornos, pues riesgos a la seguridad del niño pueden ser generados.

IX) La longitud y la anchura del colchón utilizado con la cuna deben cumplir las especificaciones de este manual.

I) **Orientaciones:** La Sociedad Brasileña de Pediatría orienta a colocar al bebé para dormir de barriga hacia arriba, pues disminuye en un 70% el riesgo de muerte súbita. Recomendamos conversar con el pediatra de su hijo para mayor información.

II) Sólo utilice la cuna cuando esté totalmente montado de acuerdo con las instrucciones del Manual de instrucciones y después de asegurarse de que sus sistemas de bloqueo están debidamente accionados.

III) La cuna debe colocarse sobre un piso horizontal.

IV) Para cunas con altura de base ajustable: La posición más baja es la más segura y la base debe ser siempre utilizada en esa posición tan pronto como el bebé tenga la edad suficiente para sentarse.

V) Cuando existan dispositivos de apoyo desmontables para apoyar la base de la cuna por encima de su posición más baja: Antes de que la cuna se utilice en su posición más baja, se deben quitar los dispositivos utilizados para apoyar la base en posiciones más altas.

VI) Las conexiones de montaje siempre deben ajustarse adecuadamente y verificadas regularmente, a lo largo del uso de la cuna, y reapertadas según sea necesario. VII) Si alguna parte de la cuna se rompe o presenta defecto, se debe buscar asistencia técnica especializada y no realizar reparaciones caseras.

VIII) Orientaciones para el espesor del colchón, que pueden darse de las siguientes formas:

a) La longitud y la anchura del colchón utilizado con la cuna deben ser tales que nunca sea posible la formación de espacio mayor a 30 mm entre los laterales o los extremos y el colchón.

b) El espesor del colchón debe ser tal que la altura interna (de la superficie del colchón hasta el borde superior del armazón de la cuna) sea de al menos 480 mm en la posición más baja de la base de la cuna y al menos 180 mm en la posición más elevada de la base de la cuna.

c) cuando se utilice un marcado en la cuna para indicar el espesor máximo del colchón: El marcado en la cuna indica el grosor máximo del colchón que se utilizará con la cuna.

IX) Recomendación sobre el tamaño mínimo de colchón que se utilizará con la cuna. Para la Cuna Mini Cama Confete, se recomienda el uso de un colchón de 1,30 m \pm 0,5 cm longitud, 70 cm \pm 0,5 cm de ancho y 12 cm \pm 0,5 cm de alto, con una densidad mínima de 18 kg / m³ \pm 2,0 kg / m³ (D18).

WARNING READ WITH ATTENTION AND SAVE FOR EVENTUAL CONSULTATIONS

- I) **Warnings:** Do not position or use the product near open flame and other sources of heat such as electric heaters, gas heaters or other sources as the material is flammable.
- II) Do not use the crib if any part is broken, torn or missing. Use only replacement parts recommended by the manufacturer.
- III) Do not leave any object in or near the crib that may serve as a foothold or risk of suffocation, choking or strangulation, such as ropes, blinds / curtain cords, protectors, cushions, toys, wires and cables of electrical appliances.
- IV) Never use more than one mattress in the crib.
- V) Small children may not play, unattended, in the vicinity of a crib.
- VI) **Caution:** when the child is able to climb the crib, it can no longer be used by this child, as this crib was built for use by children with motor ability to sit, kneel and / or get up alone but not yet able to climb the crib.
- VII) For cribs with more than one function, not subject to regulation: This product complies with regulations for baby cribs, and its other functions are not subject to regulation.
- VIII) This crib can not be altered, either in its structure or in its adornments, because risks to the child's safety can be generated.
- IX) The length and width of the mattress used with the crib must comply with the specifications of this Manual.
- I) **Guidelines:** The Brazilian Society of Pediatrics advises to place the baby to sleep on his belly up, as it reduces the risk of sudden death by 70%. We recommend talking to your child's pediatrician for more information.
- II) Only use the crib when fully assembled in accordance with the instructions in the Instruction Manual and after making sure that your locking systems are properly engaged.
- III) The crib must be placed on a horizontal floor.
- IV) For cribs with adjustable base height: The lowest position is the safest and the base should always be used in this position as soon as the baby is old enough to sit.
- V) When there are detachable supporting devices to support the crib base above its lowest position: Before the crib is used in its lowest position, the devices used to support the crib in the highest positions should be removed.
- VI) The mounting connections must always be tightened properly and checked regularly, throughout the use of the crib, and retightened as necessary.
- VII) If any part of the crib breaks or is defective, you should look for expert technical assistance and no home repairs.
- VIII) Guidelines for the thickness of the mattress, which may be given in the following ways:
- a) The length and width of the mattress used with the crib shall be such that it is never possible to form a space greater than 30 mm between the sides or ends and the mattress.
- b) The thickness of the mattress shall be such that the inner height (from the mattress surface to the upper edge of the cradle frame) is at least 480 mm in the lowest position of the cradle base and at least 180 mm in the highest position of the cradle of the crib.
- c) When a marking is used on the crib to indicate the maximum thickness of the mattress: The marking on the crib indicates the maximum thickness of the mattress to be used with the crib.
- IX) Recommendation on the minimum size of mattress to be used with the crib. For Crib Mini Bed Confete, the use of a 1,30 m \pm 0.5 cm mattress is recommended length, 70 cm \pm 0,5 cm wide and 12 cm \pm 0,5 cm high, with a minimum density of 18 kg / m³ \pm 2,0 kg / m³ (D18).

**O REGISTRO NO INMETRO E O
SELO DE IDENTIFICAÇÃO DA
CONFORMIDADE REFEREM-SE
SOMENTE AO BERÇO**

**EL REGISTRO EN EL INMETRO Y
EL SELLO DE IDENTIFICACIÓN
DE LA CONFORMIDAD SE
REFERE SOLAMENTE AL BERZO**







**THE INMETRO REGISTRATION
AND THE CONFORMITY IDEN-
TIFICATION SEAL REFER ONLY
TO THE CRIB**

PASSO 1

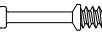
PEÇAS NECESSÁRIAS

1 - PÉ	x4
2 - TRAVESSA ESTRUTURAL	x2
8 - MOLDURA SUPERIOR	x2
10 - MOLDURA SUPERIOR MAIOR	x2
11 - TRAVESSA PARA BERÇO	x2

FERRAGENS NECESSÁRIAS

G		x04
H		x04
J		x08
K		x06
L		x04
M		x04
N		x04
P		x01

FERRAMENTAS

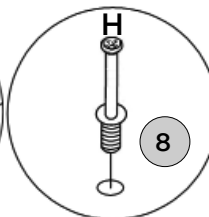
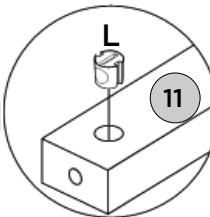
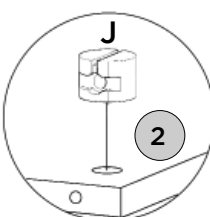
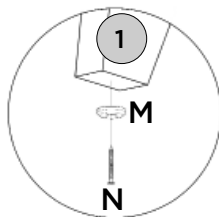
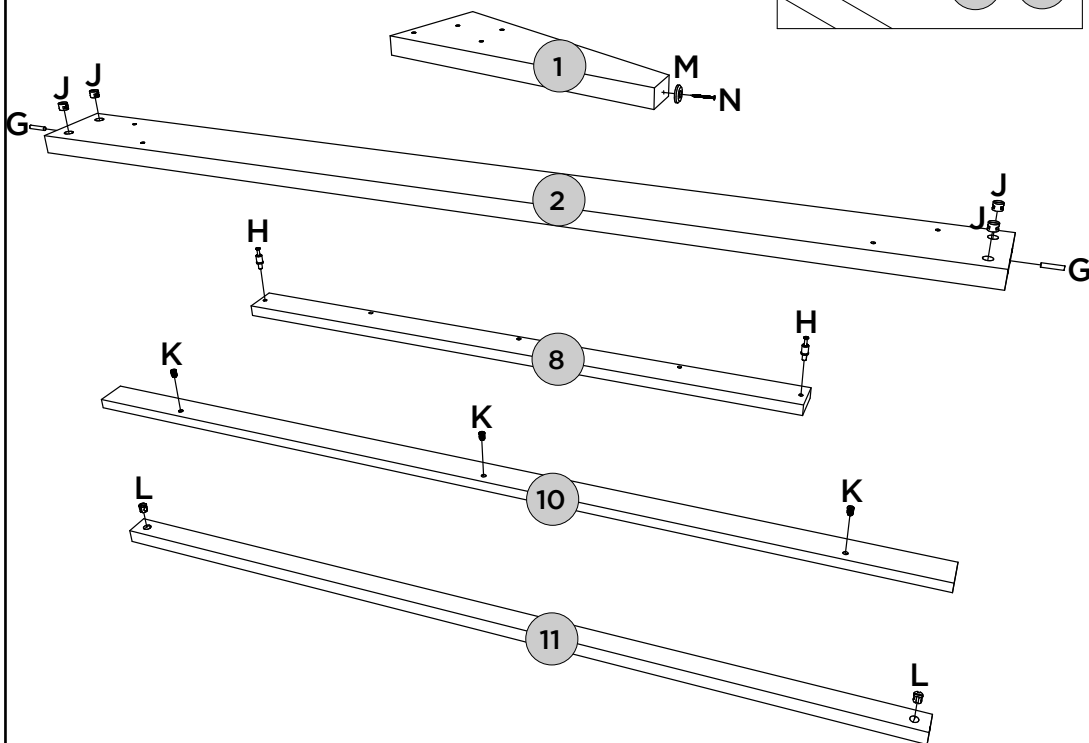
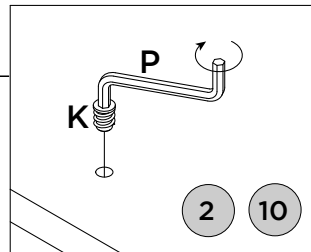
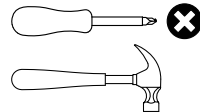

PASSO 2**PEÇAS NECESSÁRIAS**

3 - LATERAL	x1
4 - LATERAL COM ETIQUETA	x1

FERRAGENS NECESSÁRIAS

G		x12
Q		

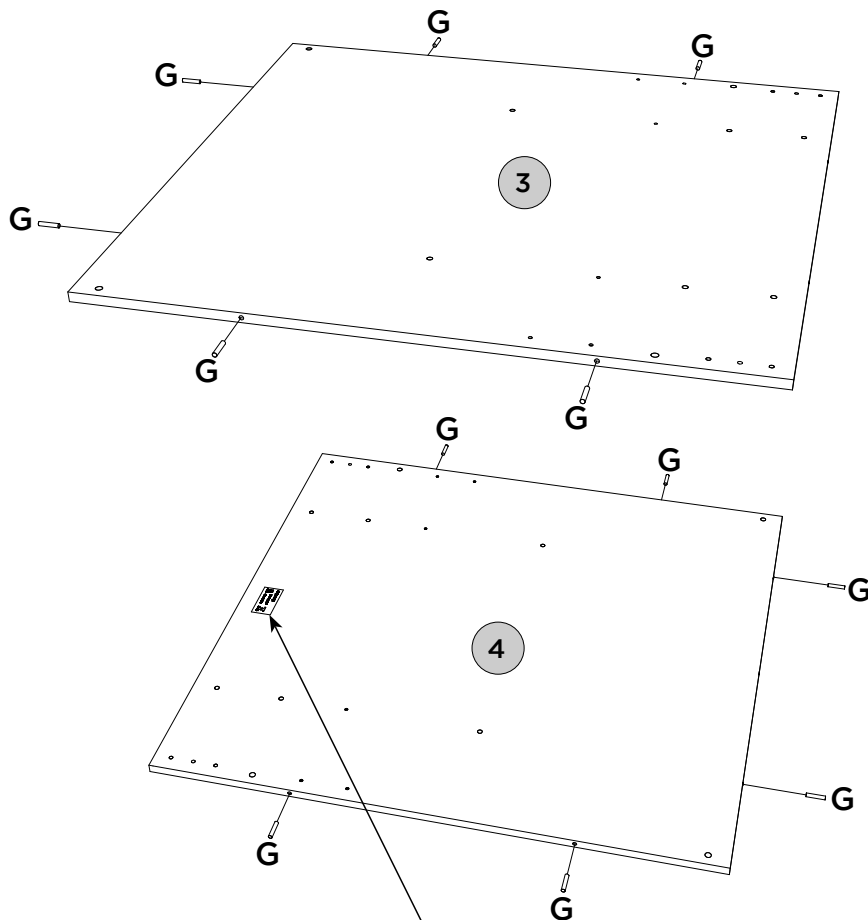
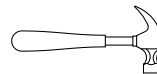
FERRAMENTAS

Selo de identificação da conformidade.

Sello de identificación de la conformidad.



Conformity identification seal.



PASSO 3**PEÇAS NECESSÁRIAS**

1 - PÉ	x4
2 - TRAVESSA ESTRUTURAL	x2

FERRAGENS NECESSÁRIAS

C		x04
D		x08
E		x08

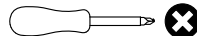
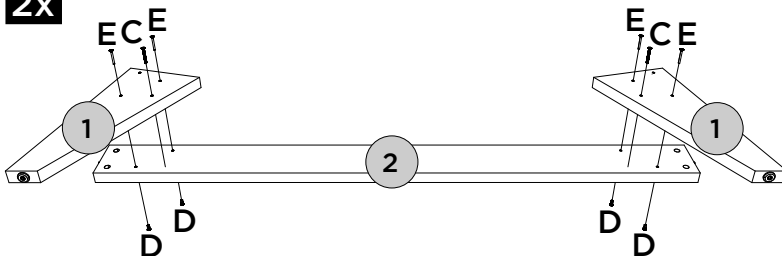
FERRAMENTAS**2x**

As peças (1 e 2) não podem ser removidos para fins de transporte, armazenamentos e/ou alteração de função.



Las piezas (1 y 2) no se pueden quitar con fines de transporte, almacenamiento y/o cambio de función.

Parts (1 and 2) cannot be removed for transport, storage and/or function change purposes.

PASSO 4**PEÇAS NECESSÁRIAS**

3 - LATERAL	x1
4 - LATERAL COM ETIQUETA	x1
5 - MOLDURA INFERIOR	x2
6 - MOLDURA LATERAL ESQ.	x2
7 - MOLDURA LATERAL DIR.	x2
8 - MOLDURA SUPERIOR	x2

FERRAGENS NECESSÁRIAS

I		x04
Q		
T		x08

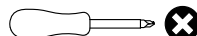
FERRAMENTAS

Depois de fazer a montagem destas peças, as mesmas não podem ser removidas para fins de transporte, armazenamentos e/ou alteração de função.

Después de ensamblar estas piezas, no se pueden quitar para el transporte, almacenamiento y/o cambio de rol.

After assembling these parts, they cannot be removed for transport, storage and/or role change.

Furações alinhadas e voltadas para a face interna da lateral

Agujeros alineados y orientados hacia la cara interior del lateral

Holes aligned and facing the inner face of the side

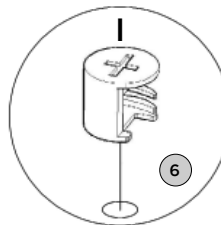
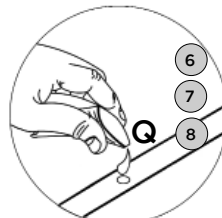
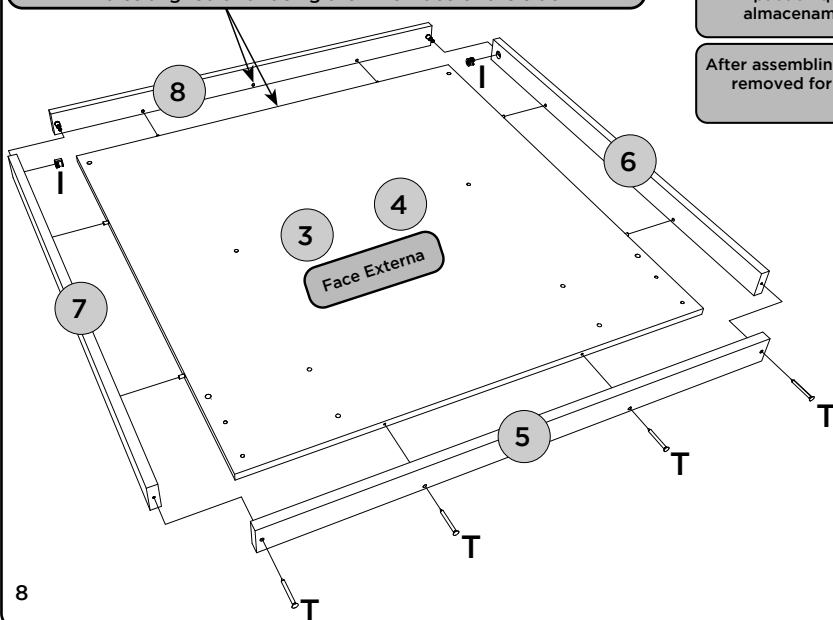

PASSO 5**PEÇAS NECESSÁRIAS**

9 - GRADE x2

10 - MOLDURA SUPERIOR MAIOR x2

FERRAGENS NECESSÁRIASA  x06**FERRAMENTAS**

OU

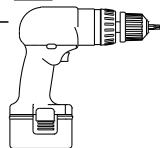
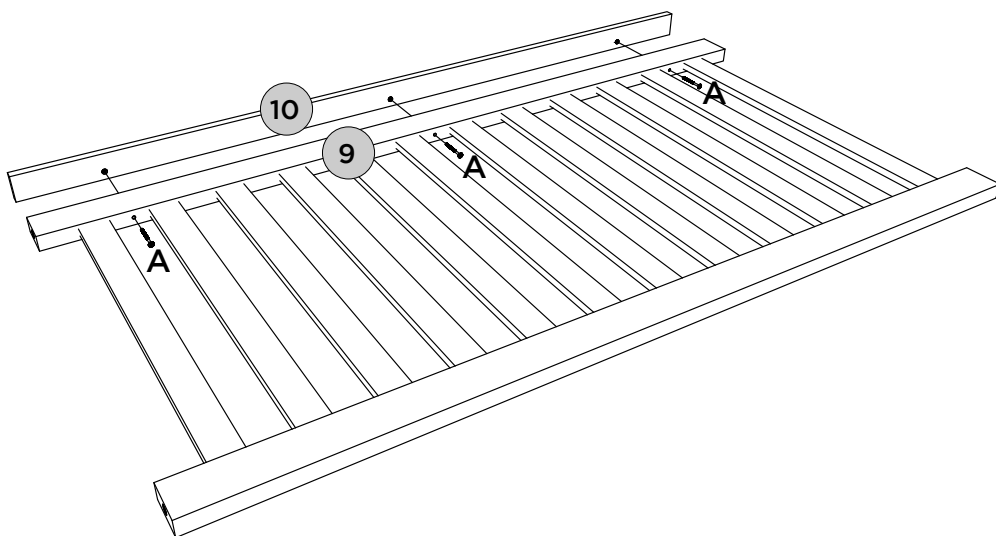
**2x**

PASSO 6**PEÇAS NECESSÁRIAS**

1 - PÉ	x4
2 - TRAVESSA ESTRUTURAL	x2
3 - LATERAL	x1

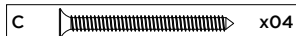
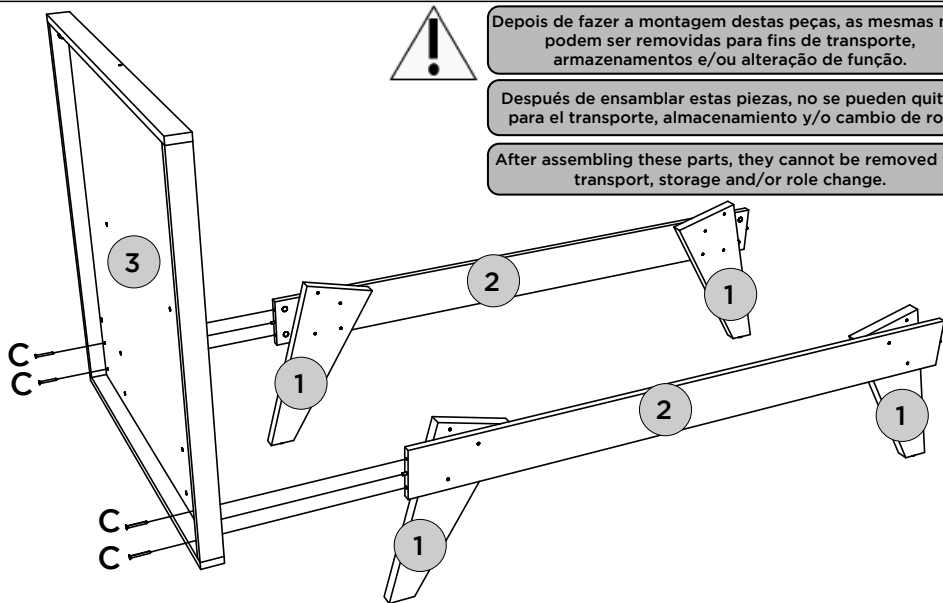
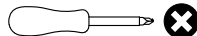
FERRAGENS NECESSÁRIAS**FERRAMENTAS**

Depois de fazer a montagem destas peças, as mesmas não podem ser removidas para fins de transporte, armazenamentos e/ou alteração de função.

Después de ensamblar estas piezas, no se pueden quitar para el transporte, almacenamiento y/o cambio de rol.

After assembling these parts, they cannot be removed for transport, storage and/or role change.

PASSO 7**PEÇAS NECESSÁRIAS**

9 - GRADE	x1
-----------	----

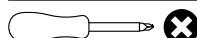
FERRAGENS NECESSÁRIAS**FERRAMENTAS**

OU

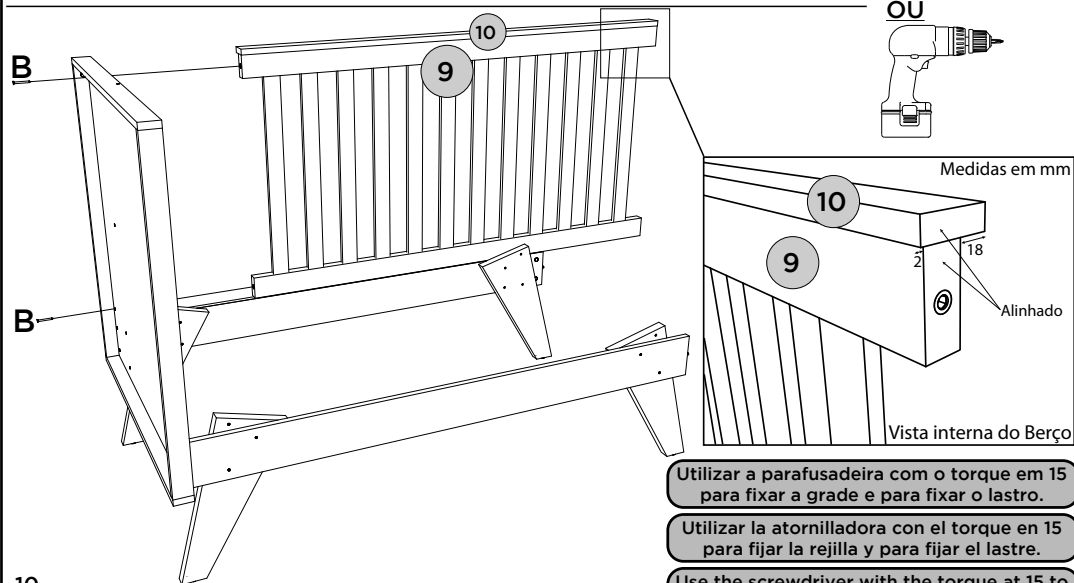
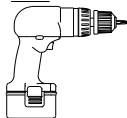

Medidas em mm

Alinhado

Vista interna do Berço

Utilizar a parafusadeira com o torque em 15 para fixar a grade e para fixar o lastro.

Utilizar la atornilladora con el torque en 15 para fijar la rejilla y para fijar el lastre.

Use the screwdriver with the torque at 15 to attach the rail and base frame.



Opções para montar o Lastro

Opções para montar o Lastro

Opções para montar o Lastro

Vista Interna da Lateral

Vista Interna Lateral

Side Internal View

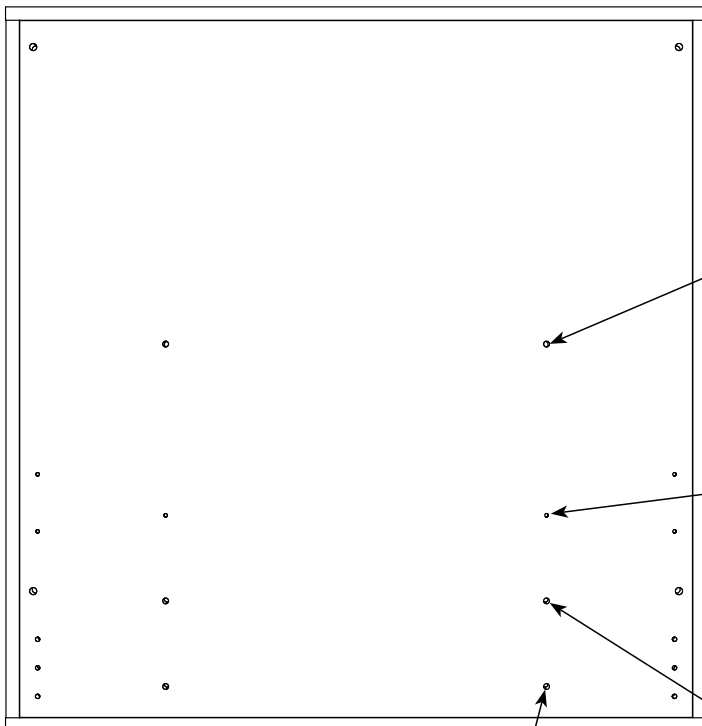

Furação para Berço -
Opção mais alta do lastro

Perforación de cuna -
Opción de lastre superior

Cradle Drilling -
Higher Ballast Option

Furação para Opção
Mini Cama

Mini cama Opción de
perforación

Mini Bed Option Drilling

Furação para Berço -
Opção mais baixa do lastro

Perforación de cuna -
Opción de lastre inferior

Cradle Drilling -
Lower Ballast Option

Furação para Opção
Montessoriana

Perforación para Opción
Montessori

Drilling for Option
Montessori

PASSO 9**PEÇAS NECESSÁRIAS**

11 - TRAVESSA PARA BERÇO x2

FERRAGENS NECESSÁRIASB  x02C  x02**FERRAMENTAS**

OU

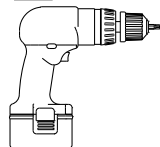

Utilizar a parafusadeira com o torque em 15 para fixar a grade e para fixar o lastro.

Utilizar la atornilladora con el torque en 15 para fijar la rejilla y para fijar el lastre.

Use the screwdriver with the torque at 15 to attach the rail and base frame.

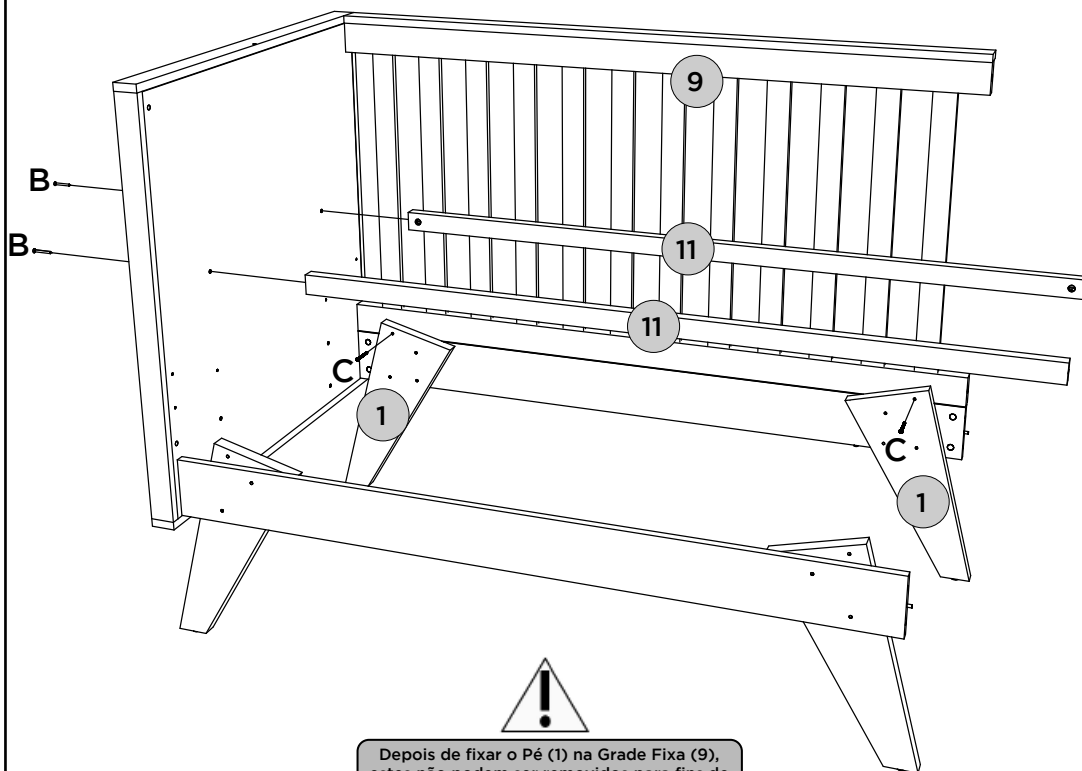

Depois de fixar o Pé (1) na Grade Fixa (9), estes não podem ser removidos para fins de transporte, armazenamentos e/ou alteração de função.

Después de acoplar el Pie (1) a la Rejilla Fija (9), no se pueden retirar para transporte, almacenamiento y/o cambio de función.

After attaching the Foot (1) to the Fixed Grid (9), they cannot be removed for transport, storage and/or change of function.

PASSO 10**PEÇAS NECESSÁRIAS**

4 - LATERAL COM ETIQUETA x1

FERRAGENS NECESSÁRIASB  x04C  x04**FERRAMENTAS**

OU

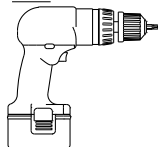

Utilizar a parafusadeira com o torque em 15 para fixar a grade e para fixar o lastro.

Utilizar la atornilladora con el torque en 15 para fijar la rejilla y para fijar el lastre.

Use the screwdriver with the torque at 15 to attach the rail and base frame.

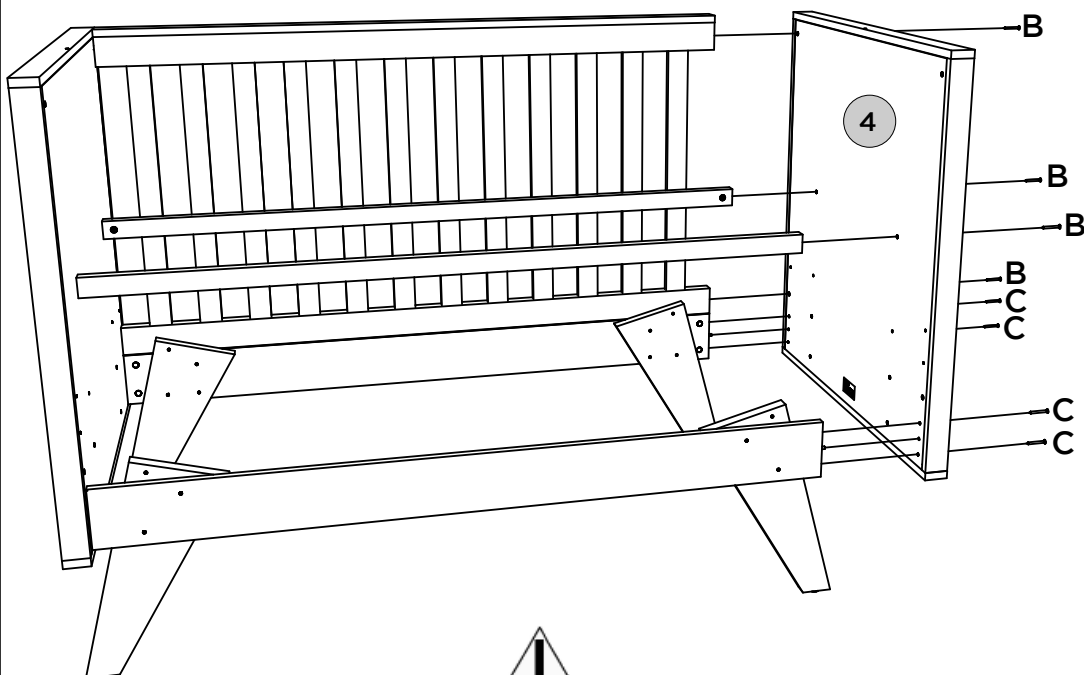

Depois de fixar com os parafusos (C), as peças que estão unidas não podem ser removidas para fins de transporte, armazenamentos e/ou alteração de função.

Después de fijar con los tornillos (C), las partes que van unidas no se pueden desmontar para transporte, almacenaje y/o cambio de función.

After fixing with the screws (C), the parts that are joined together cannot be removed for transport, storage and/or change of function.

PASSO 11

PEÇAS NECESSÁRIAS

12 - LASTRO MAIOR 6MM COM CARIMBO x1

13 - LASTRO MAIOR 6MM x2

FERRAGENS NECESSÁRIAS

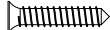
F  x12

FERRAMENTAS

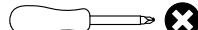

OU

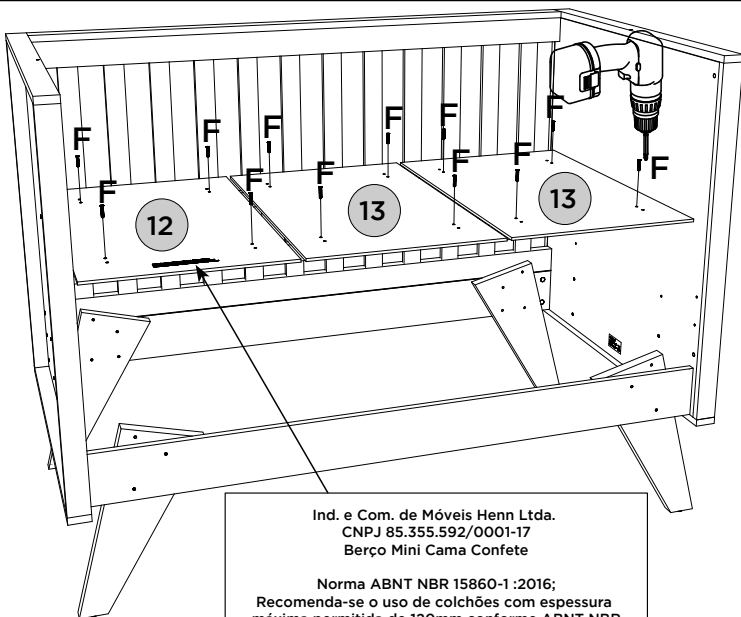
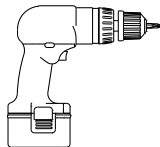

Ind. e Com. de Móveis Henn Ltda.
CNPJ 85.355.592/0001-17
Berço Mini Cama Confeite

Norma ABNT NBR 15860-1:2016;
Recomenda-se o uso de colchões com espessura
máxima permitida de 120mm conforme ABNT NBR
13579-1.

PEDIDO: (numero) LOTE: (numero) DATA: (dia/mês/ano)

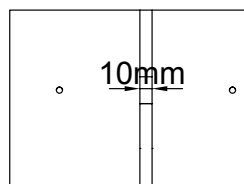

A distância entre os
lastros deve ser 10mm.

La distancia entre los
lastres debe ser 10mm.

The distance between
ballast should be 10mm.

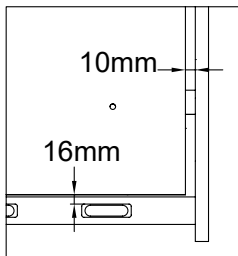

Para a opção mais alta a distância
entre os lastros da extremidade com as
laterais deverá ser de 10mm.

Para la opción más alta, la distancia
entre los balastos en el extremo y los
lados debe ser de 10 mm.

For the highest option, the distance
between the ballasts at the end and the
sides should be 10mm.

As extremidades dos lastros (12) e (13)
devem ficar 16mm da grade fixa (9).

Lastres extremos (12) y (13) deben
quedar 16mm de la rejilla fija (9).

The end base frames (12) and (13) must
be 16mm from the fixed rail (9).



Os Lastros (12 e 13) não podem ser
removidos da travessa (11) para
fins de transporte, armazenamen-
tos e/ou alteração de função.

Los muelles (12 y 13) no se pueden
quitar del tramo (11) con el fin
de transporte, almacenamiento y /
o cambio de función.

The ballasts (12 and 13) can not be
removed from the beam (11) for
purposes of transportation, storage
and / or change of function.

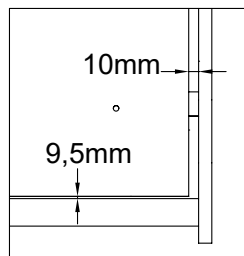

Para a opção mais baixa a distância entre
os lastros da extremidade com as laterais
deverá ser de 10mm.

Para la opción más baja, la distancia
entre los balastos de los extremos y los
laterales debe ser de 10 mm.

For the lowest option, the distance
between the end ballasts and the sides
must be 10mm.

As extremidades dos lastros (12) e (13) devem
ficar 9,5mm da grade fixa (9).

Lastres extremos (12) y (13) deben quedar
9,5mm de la rejilla fija (9).

The end base frames (12) and (13) must be
9,5mm from the fixed rail (9).

PASSO 12

PEÇAS NECESSÁRIAS

9 - GRADE	x1
14 - SUPORTE MOSQUITEIRO	x1

FERRAGENS NECESSÁRIAS

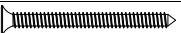
B		x04
C		x02

FERRAMENTAS

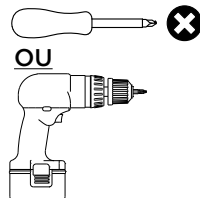

OU

Utilizar a parafusadeira com o torque em 15 para fixar a grade e para fixar o lastro.

Utilizar la atornilladora con el torque en 15 para fijar la rejilla y para fijar el lastro.

Use the screwdriver with the torque at 15 to attach the rail and base frame.



Depois de fixar o Pé (1) na Grade Fixa (9), estes não podem ser removidos para fins de transporte, armazenamentos e/ou alteração de função.

Después de acoplar el Pie (1) a la Rejilla Fija (9), no se pueden retirar para transporte, almacenamiento y/o cambio de función.

After attaching the Foot (1) to the Fixed Grid (9), they cannot be removed for transport, storage and/or change of function.

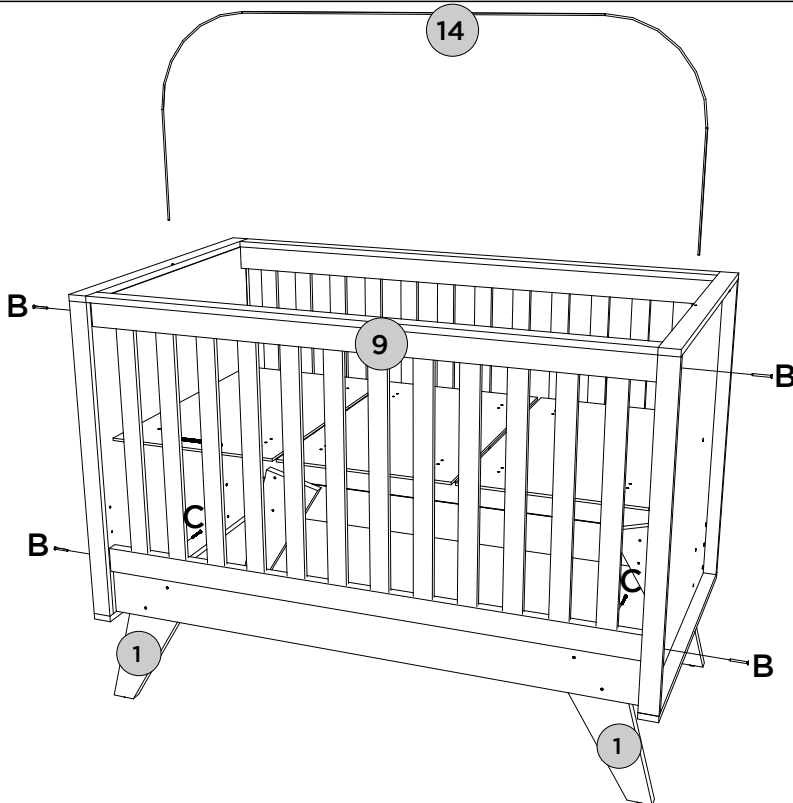

Montagem berço concluída

Montaje cuna completa

Completed crib assembling

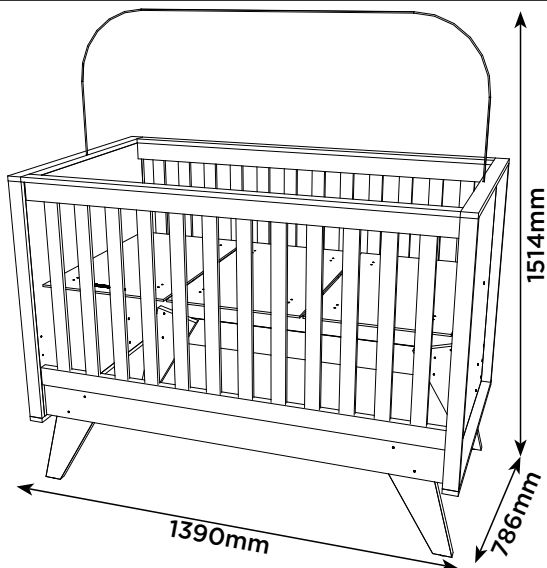

Para a montagem do Montessoriano, tirar as peças marcadas com "X" e o restante das peças deverão ser utilizadas.

Para el montaje del Montessoriano, sacar las piezas marcadas con "X" y el resto de las piezas deberán ser utilizadas.

To assemble the Montessoriano, remove the parts marked with "X" and the rest of the pieces should be used.

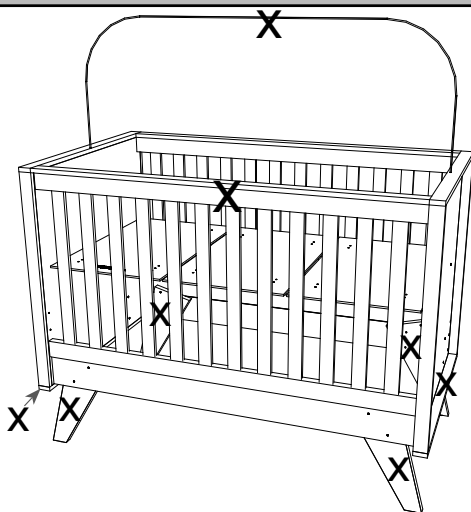

PASSO 13

PEÇAS NECESSÁRIAS

2 - TRAVESSA ESTRUTURAL	x2
3 - LATERAL	x1
4 - LATERAL COM ETIQUETA	x1
6 - MOLDURA LATERAL ESQ.	x2
7 - MOLDURA LATERAL DIR.	x2
8 - MOLDURA SUPERIOR	x2
9 - GRADE	x1
10 - MOLDURA SUPERIOR MAIOR	x1
11 - TRAVESSA PARA BERÇO	x2
12 - LASTRO MAIOR 6MM COM CARIMBO x1	
13 - LASTRO MAIOR 6MM	x2

FERRAGENS NECESSÁRIAS

B		x08
C		x08
N		x04
O		x04
R		x04
S		x54

FERRAMENTAS

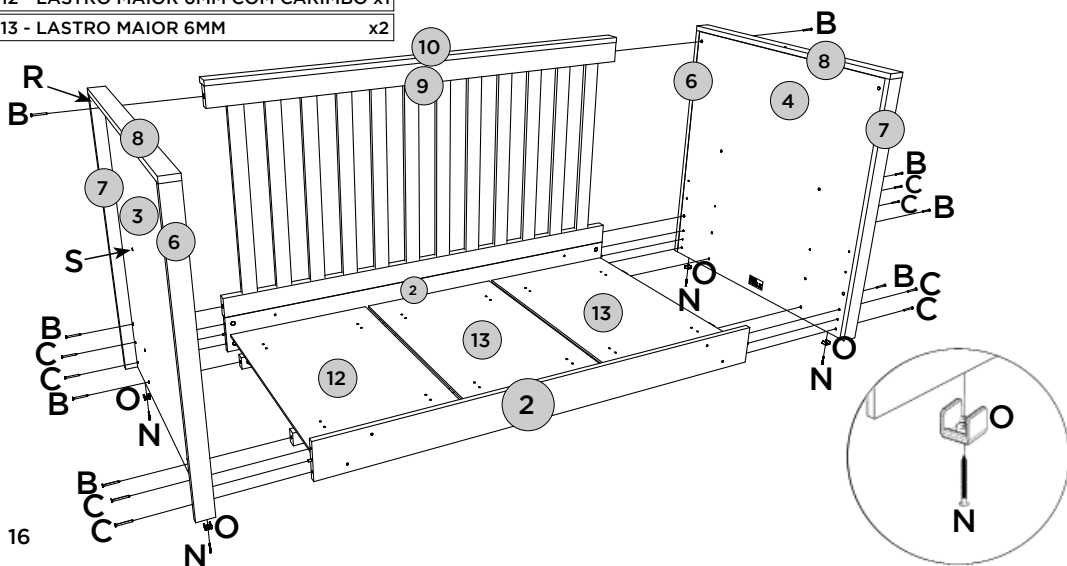
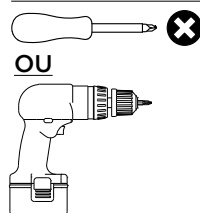

Montessoriano concluído

Montessoriano concluido

Montessoriano completed

Na Opção Montessoriano pode ser utilizado os Adesivos Tapa parafusos (R e S), aonde há furos aparentes.

En la Opción Montessori puedes utilizar el Adhesivos Tapa tornillos (R y S), donde hay agujeros visibles.

In the Montessori Option you can use the Adhesives Cover screws (R and S), where there are visible holes.

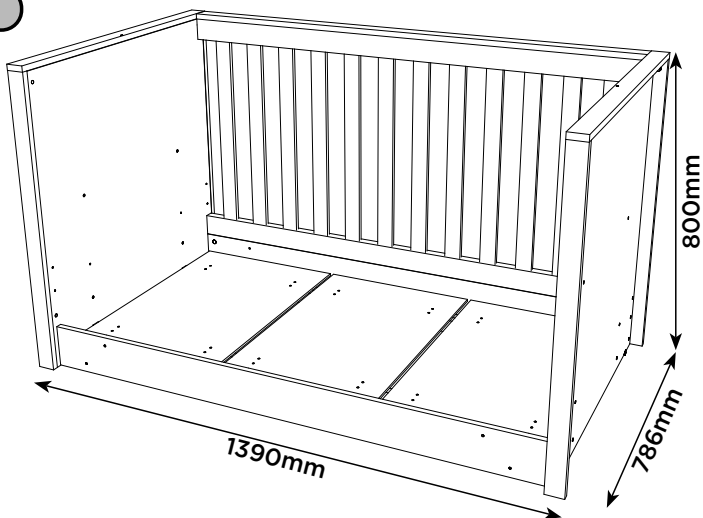

Advertência: Após montada o Mini Cama não se pode montar mais na versão Berço.

Advertencia: Una vez montada la Mini Cama, ya no se podrá montar en la versión Cuna.

Warning: Once the Mini Bed has been assembled, it can no longer be assembled in the Cradle version.

Para a montagem da mini cama, tirar as peças marcadas com "X" e o restante das peças deverão ser utilizadas para a montagem da mini cama.

Para el montaje de la mini cama, sacar las piezas marcadas con "X" y el resto de las piezas deberán ser utilizadas para el montaje de la mini cama.

To assemble the mini bed, remove the parts marked with "X" and the remaining parts should be used to assemble the mini bed.

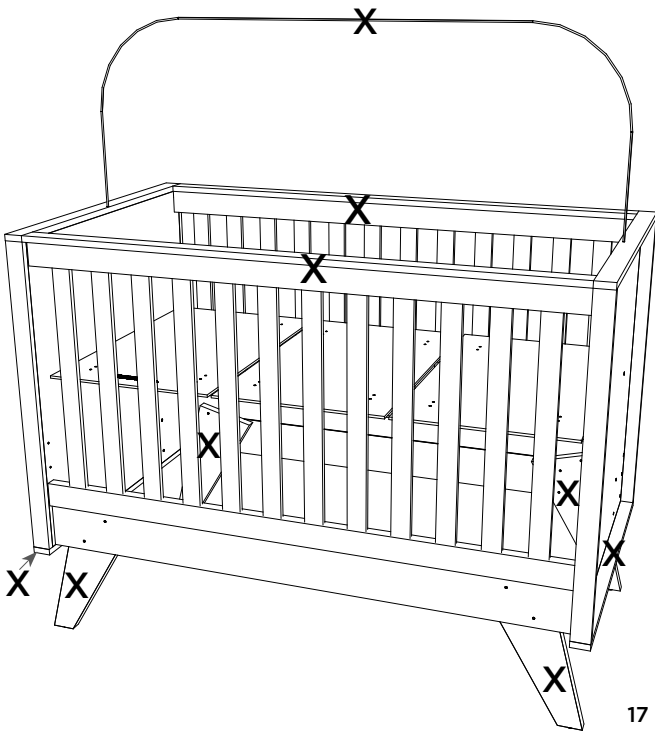







PASSO 14

PEÇAS NECESSÁRIAS

2 - TRAVESSA ESTRUTURAL	x2
3 - LATERAL	x1
4 - LATERAL COM ETIQUETA	x1
6 - MOLDURA LATERAL ESQ.	x2
7 - MOLDURA LATERAL DIR.	x2
8 - MOLDURA SUPERIOR	x2
11 - TRAVESSA PARA BERÇO	x2
12 - LASTRO MAIOR 6MM COM CARIMBO x1	
13 - LASTRO MAIOR 6MM	x2

FERRAGENS NECESSÁRIAS

B		x04
C		x08
N		x04
O		x04
R		x04
S		x78

FERRAMENTAS

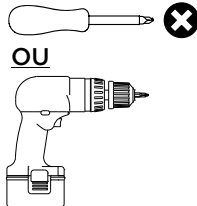

Fazer furação passante com broca de 6,5mm

Perforar a través com broca de 6,5mm

Drill through with 6,5mm drill bit

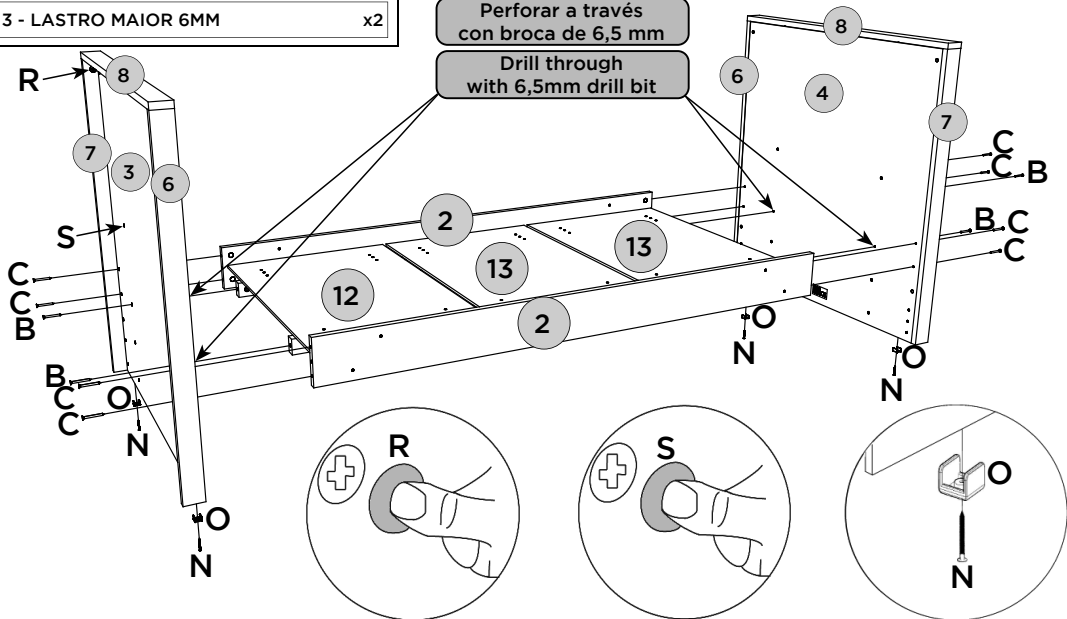

Mini Cama concluído

Mini cama completa

Mini Bed Complete

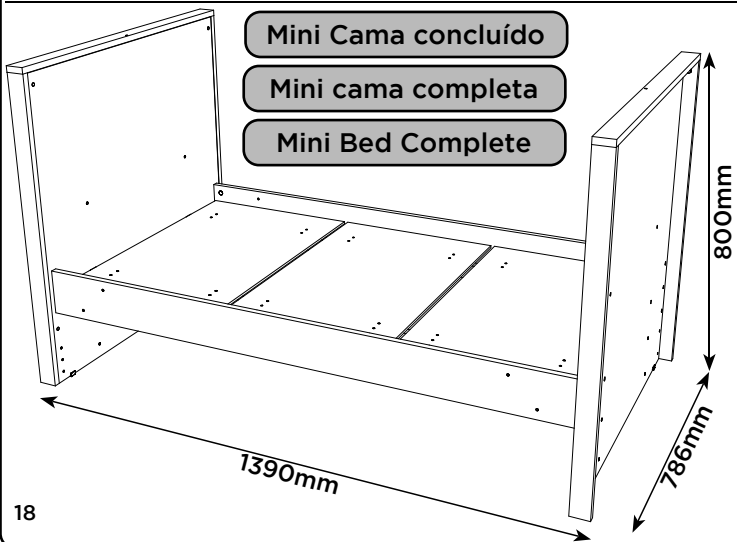











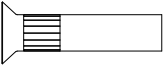
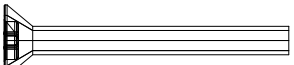
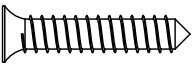

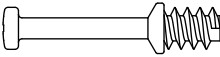
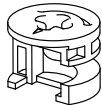

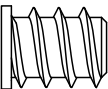
Na Opção Mini Cama pode ser utilizado os Adesivos Tapa parafusos (R e S), aonde há furos aparentes.

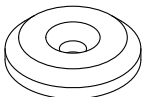
En la Opción de Mini Cama, se pueden usar los Adhesivos para Cubiertas de Tornillos (R y S), donde hay agujeros aparentes.

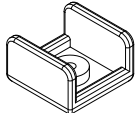
In the Mini Bed Option, the Screw Cover Adhesives (R and S) can be used, where there are apparent holes.

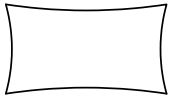
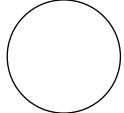
Ferragens | Herrajes | Hardware

A 06x  Parafuso M4x70mm CHT Tornillo M4x70mm CHT Screw M4x70mm CHT	B 12x  Parafuso 1/4x50mm PAN. Tornillo 1/4x50mm PAN. Screw 1/4x50mm PAN.	C 16x  Parafuso 4,0x45mm CHT. Tornillo 4,0x45mm CHT. Screw 4,0x45mm CHT.
D 08x  Parafuso União Fêmea 22mm Tornillo Unión Hembra 22mm Female Union Screw 22mm	E 08x  Parafuso 35mm CHT Philips Rosca M4 Tornillo 35mm CHT Philips Rosca M4 Screw 35mm CHT Philips Thread M4	F 12x  Parafuso 4,5x25mm CHT. Tornillo 4,5x25mm CHT. Screw 4,5x25mm CHT.
G 16x  Cavilha 5x25mm Tarugo 5x25mm Dowel 5x25mm	H 04x  Parafuso minifix Tornillo minifix Minifix bolt	I 04x  Tambor minifix Tambor minifix Minifix nut
J 08x  Porca cilíndrica Tuerca cilíndrica Cylindrical nut	K 06x  Bucha Americana M4x10mm Bucha Americana M4x10mm Bushing American M4x10mm	L 04x  Porca Zamac 12x12 Tuerca Zamac 12x12 Zamac nut 12x12
M 04x  Sapata Deslizadora Zapata Deslizadora shoe Deslizadora	N 08x  Prego 12x12mm Anelado Clavo 12x12mm Anillado Ringed Nails 12x12mm	O 04x  Sapata "U" 12x15mm Zapata "U" 12x15mm "U" shoe 12x15mm
P 01x  Chave Allen Llave Allen Allen key	Q 01x  Sachê de cola Bolsa de pegamento Glue bag	R 04x  Adesivo tapa parafuso 17mm Adhesivo tapón de tornillo 17mm Bolt cover adhesive 17mm
S 78x  Adesivo tapa parafuso 10mm Adhesivo tapón de tornillo 10mm Bolt cover adhesive 10mm	T 08x  Parafuso 3,5x40mm CHT. Tornillo 3,5x40mm CHT. Screw 3,5x40mm CHT.	

**IMPORTANTE**

Os itens (O, R e S) serão usadas apenas na Opção Montessoriano e Mini Cama

IMPORTANTE

Los artículos (O, R y S) solo se utilizarán en la Opção Montessori y Mini Bed

IMPORTANT

Items (O, R and S) will only be used in Montessori Option and Mini Bed

Lista de Peças | Lista de piezas | List of parts

Item	Caixa Caja Box	Qtd Ctd Qty	Descrição Descripción Description	Medidas (mm) Dimensions (mm) Size (measurements) (mm)
01	1/1	04	Pé Pie Foot	405x165x25
02	1/1	02	Travessa estrutural Travesaño estructural Structural Frame	1300x110x25
03	1/1	01	Lateral Lado Side	782x755x12
04	1/1	01	Lateral com etiqueta Lateral con etiqueta Side with label	782x755x12
05	1/1	02	Moldura Inferior Marco inferior Bottom Frame	786x45x15
06	1/1	02	Moldura Lateral Esquerda Marco lateral izquierdo Left Side Frame	782x45x15
07	1/1	02	Moldura Lateral Direita Marco lateral derecho Right Side Frame	782x45x15
08	1/1	02	Moldura Superior Marco superior Top frame	786x45x15
09	1/1	02	Grade fixa Rejilla fija Fixed Rail	1300x670x25
10	1/1	02	Moldura Superior Maior Marco superior más grande Larger Top Frame	1300x45x15
11	1/1	02	Travessa para berço Travesaño para Cuna Crib Frame	1301x36x22
12	1/1	01	Lastro maior 6mm com carimbo Lastre mayor 6mm con sello 6mm Larges base Frame with seal	680x420x6
13	1/1	02	Lastro maior 6mm Lastre mayor 6mm 6mm Largest Base Frame	680x420x6
14	1/1	01	Suporte mosquito Soporte de mosquiteros Mosquito net support	1320mm



Após desmontar ou alterar a função do Berço, o mesmo não poderá ser montado novamente.

Después de desmontar o cambiar la función de la cuna, no se puede volver a montar.

After disassembling or changing the Cradle's function, it cannot be reassembled.

HENNInd. e Com. de Móveis Henn
Mondaí - SC - Brasil

☎ +55 49 3674.3500

📧 @moveishenn
www.henn.com.br**INSTRUÇÕES DE
MONTAGEM**INSTRUCCIONES DE MONTAJE
ASSEMBLY INSTRUCTIONS**Cômoda Confete 1 Porta 3 Gavetas | Cómoda Confete 1 Puerta 3 Cajones |
Dresser Confete 1 Door 3 Drawers**

1720-190 Branco/Jequitibá HP

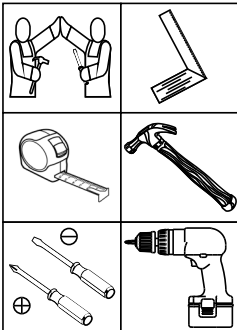
**Opção 1
Opción 1
Option 1****Opção 2
Opción 2
Option 2****Requisitos para montagem
Requisitos para la montaje
Assembly Requirements**

Imagens meramente ilustrativas,
não acompanha o produto.
Imágenes ilustrativas, no incluidas
con el producto.
Illustrative images, not included
with the product.

AVISO

Para limpeza de seu móvel, use uma flanela seca ou umedecida, e não utilize produtos químicos que possam danificar seu produto.

SISTEMA DE MONTAGEM

O sistema de montagem dos produtos, funciona de acordo com a ordem crescente dos números indicados no desenho. Ex: 01, 02, 03, 04... até a conclusão da montagem.

ASSISTÊNCIA TÉCNICA

Para solicitação de Assistência Técnica você consumidor deverá entrar em contato com o Lojista a qual você realizou a compra deste produto e solicitar a assistência técnica das peças avariadas. A garantia abrange todas as peças, partes e componentes que eventualmente venham apresentar defeito de fabricação no prazo de 03 (três) meses, contando a partir da entrega do produto ao consumidor, mediante nota fiscal de compra. Se houver qualquer alteração na estrutura do produto ou ocorrer defeito por negligência do montador/consumidor em relação a instrução de montagem e manuseio, não será fornecido assistência técnica gratuita.

ADVERTENCIA

Para limpieza de su móvil, use una flanela seca o húmeda, y no utilice productos químicos que puedan dañar su producto.

SISTEMA DE MONTAJE

El sistema de montaje de los productos funciona de acuerdo con el orden creciente de los números indicados en el dibujo. Ej.: 01, 02, 03, 04... hasta la conclusión del montaje.

ASSISTENCIA TÉCNICA

Para solicitar Asistencia Técnica, el consumidor debe comunicarse con el Comercio que usted realizó la compra de este producto y solicita asistencia técnica para las partes dañadas. La garantía cubre todas las partes, piezas y componentes que eventualmente puedan presentar defecto de fabricación en el plazo de 03 (tres) meses, contados a partir de la entrega del producto al consumidor, mediante factura de compra. Si se produce algún cambio en la estructura del producto o se produce un defecto por negligencia del montador/consumidor en relación con las instrucciones de montaje y manipulación, no se prestará asistencia técnica gratuita.

NOTICE

To clean your furniture, use a dry or wet cloth, and do not use chemicals that may damage your product.

ASSEMBLY SYSTEM

The products' assembly system works according to the increasing order of the indicated numbers. For example: 01, 02, 03, 04 ... to the end of the assembly.

TECHNICAL ASSISTANCE

To request Technical Assistance, the consumer must contact the retailer from whom you purchased this product and request technical assistance for the damaged parts. The warranty covers all parts, parts and components that may eventually present a manufacturing defect within a period of 03 (three) months, counting from the delivery of the product to the consumer, by means of a purchase invoice. If there is any change in the structure of the product or defect occurs due to negligence of the assembler/consumer in relation to the assembly and handling instruction, free technical assistance will not be provided.

ACESSÓRIOS | ACCESORIOS | ACCESSORIES

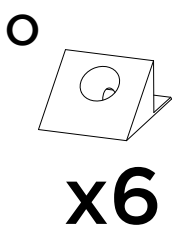
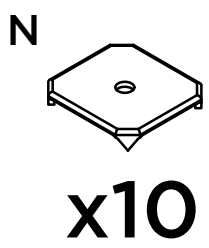
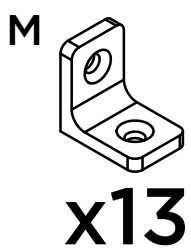
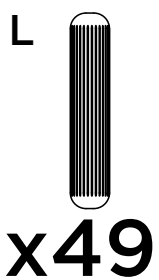
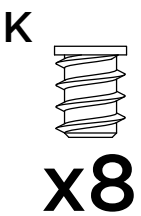
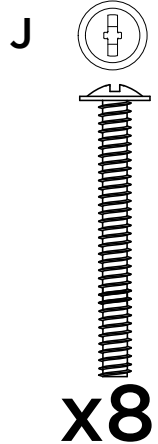
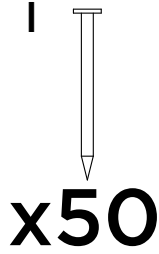
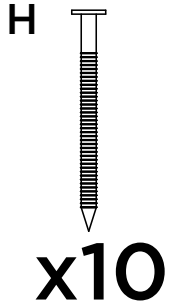
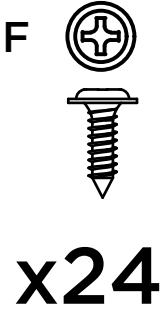
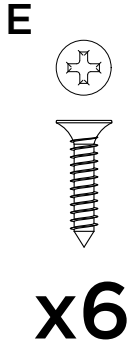
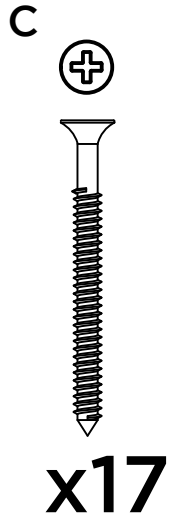
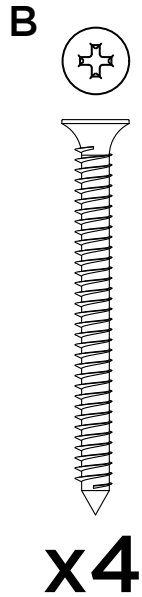
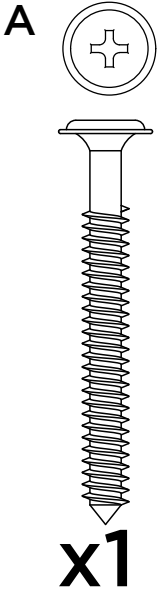

Parafusos em escala
Tornillos escalados
Scaled screws 1:1

ACESSÓRIOS | ACCESORIOS | ACCESSORIES

P 
x12

Q 
x4

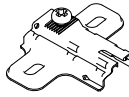
R 
x2

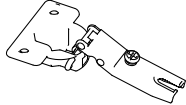
S 
x2

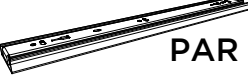
T 
PAR
x3

U 
x1

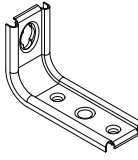
V 
x1

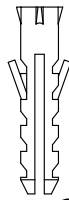
W 
x1

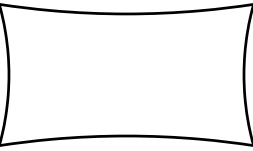
X 
x2

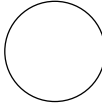
Y 
x14

Z 
x3

AA 
HENN
x1

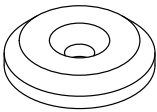
AB 
x4

AC 
x1

AD 
x8

Parafusos em escala
Tornillos escalados
Scaled screws

1:1

LISTA DE PEÇAS | LISTA DE PIEZAS | LIST OF PIECES

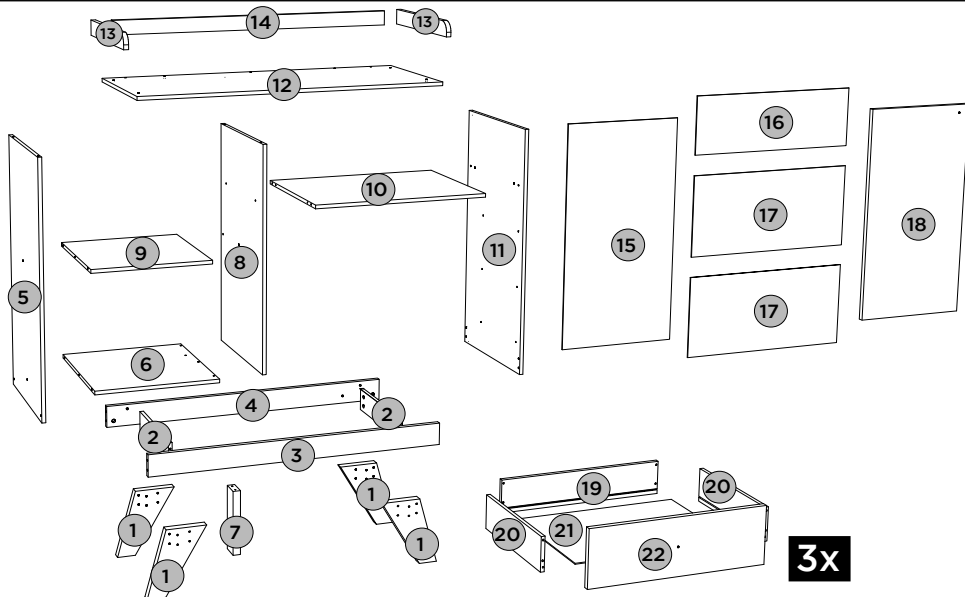

3x

Item	Caixa Caja Box	Qty Ctd Qty	Descrição Descripción Description	Dimensões (mm) Dimensiones (mm) Dimensions (mm)		
				Comprimento Largo Length	Largura Ancho Width	Espessura Grosor Thickness
1	1/1	4	PÉ PIE FOOT	191	223	25
2	1/1	2	TRAVESSA DO RODAPÉ TRAVESAÑO DE PIE DE PÁGINA FOOTER CROSSPIECE	73	324	12
3	1/1	1	RODAPÉ FRONTAL PIE DE PÁGINA FRONTAL FRONT FOOTER	73	954	15
4	1/1	1	RODAPÉ TRASEIRO PIE DE PÁGINA POSTERIOR REAR FOOTER	73	954	15
5	1/1	1	LATERAL ESQUERDA LADO IZQUIERDO LEFT SIDE	829	410	12
6	1/1	1	BASE BASE BASE	391	410	12
7	1/1	1	PÉ CENTRAL PIE CENTRAL CENTER FOOT	223	60	25
8	1/1	1	DIVISÃO DIVISIÓN DIVISION	744	410	12
9	1/1	1	PRATELEIRA FIXA ESTANTE FIJO FIXED SHELF	379	379	12
10	1/1	1	TAMPO DAS GAVETAS PARTE SUPERIOR DEL CAJÓN DRAWER TOP	563	410	12
11	1/1	1	LATERAL DIREITA LADO DERECHO RIGHT SIDE	829	410	12
12	1/1	1	TAMPO CUBRIR COVER	980	410	12
13	1/1	2	MOLDURA LATERAL MARCO LATERAL SIDE FRAME	390	50	15
14	1/1	1	MOLDURA SUPERIOR MARCO SUPERIOR TOP FRAME	917	48	15
15	1/1	1	FUNDO MAIOR FONDO MÁS GRANDE BIGGER BACKGROUND	765	394	3
16	1/1	1	FUNDO MENOR FONDO INFERIOR LOWER BACKGROUND	577	202	3
17	1/1	2	FUNDO CRU FONDO CRUDO RAW BACKGROUND	578	282	3
18	1/1	1	PORTA PUERTA DOOR	756	389	15
19	1/1	3	RIPA DE TRÁS PORTÁTIL TRASERO BACK LAPTOP	543	110	12
20	1/1	6	LADO DE GAVETA LADO DEL CAJÓN DRAWER SIDE	350	110	12
21	1/1	3	FUNDO DE GAVETA FONDO DE CAJÓN DRAWER BOTTOM	530	361	3
22	1/1	3	FRENTE DE GAVETA FRENTE DE CAJÓN DRAWER FRONT	571	185	15







PASSO 1

ITM/1720-

PEÇAS REQUERIDAS

1	PÉ	x4
2	TRAVESSA DO RODAPÉ	x2
3	RODAPÉ FRONTAL	x1
4	RODAPÉ TRASEIRO	x1
7	PÉ CENTRAL	x1

ACESSÓRIOS REQUERIDOS

L		05
H		04
K		08
P		12
AB		04
AC		01



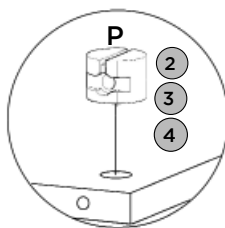
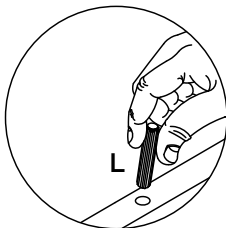
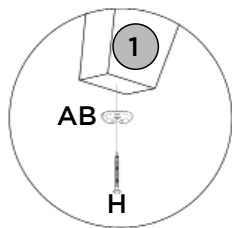
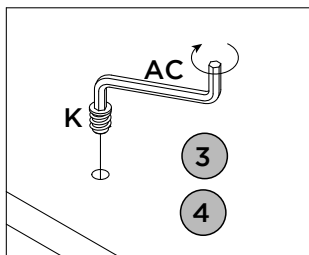
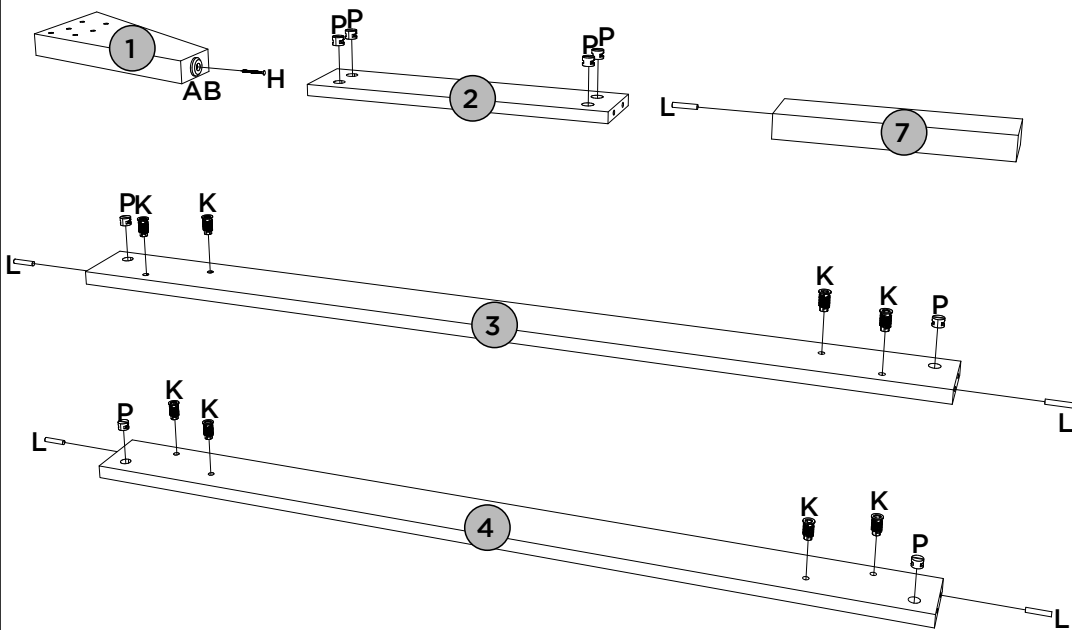
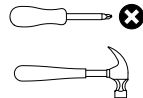

FERRAMENTAS NECESSÁRIAS



PEÇAS REQUERIDAS

5	LATERAL ESQUERDA	x1
6	BASE	x1
8	DIVISÃO	x1
9	PRATELEIRA FIXA	x1

ACESSÓRIOS REQUERIDOS

F		04
G		09
L		12
R		02
T		03

FERRAMENTAS NECESSÁRIAS

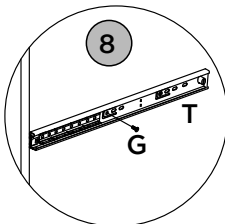
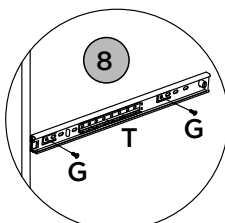
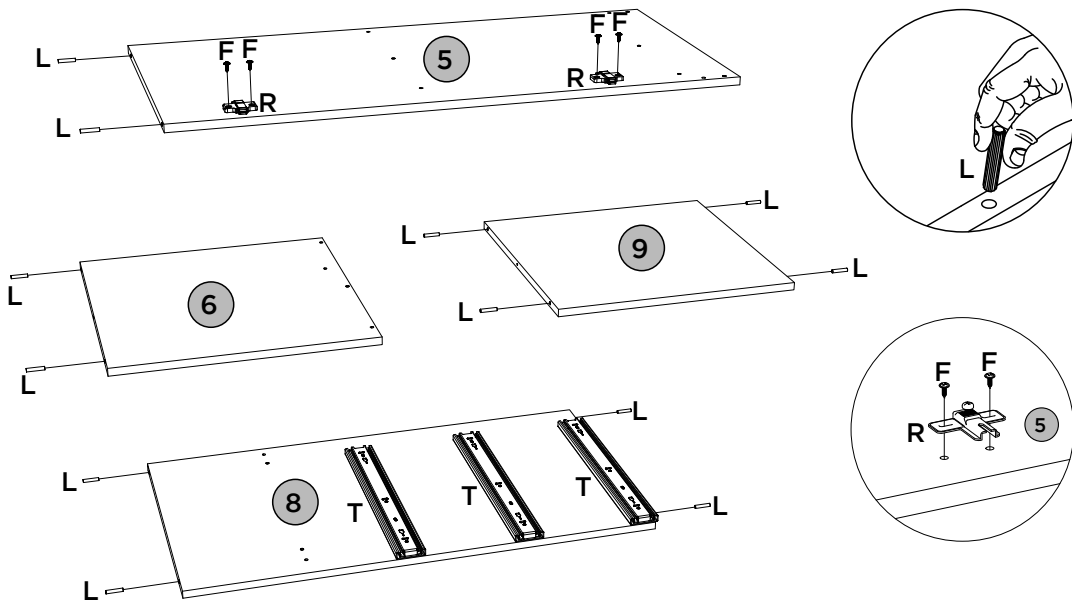
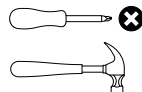

Fixar as correijas nessas furações

Fijar las dapositivas de estos agujeros
Fix the slides in these holes

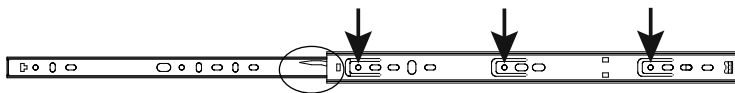

Para a desmontagem da correija, siga a instrução ao lado

Para el desmontaje de la diapositiva, siga las instrucciones en el lado

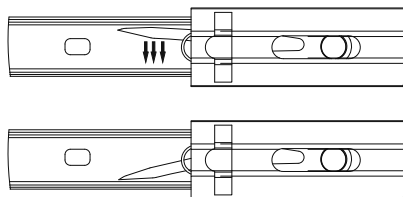

For disassembly of the slide, follow the instruction on the side



PEÇAS REQUERIDAS

10	TAMPO DAS GAVETAS	x1
11	LATERAL DIREITA	x1

ACESSÓRIOS REQUERIDOS

G		09
L		06
T		03

FERRAMENTAS NECESSÁRIAS

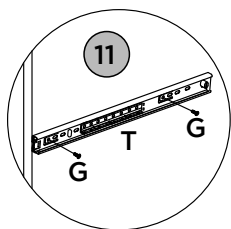
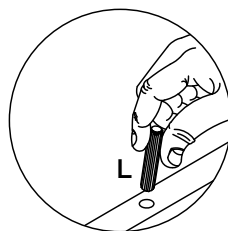
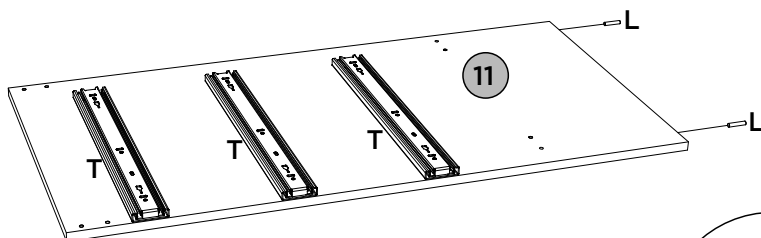
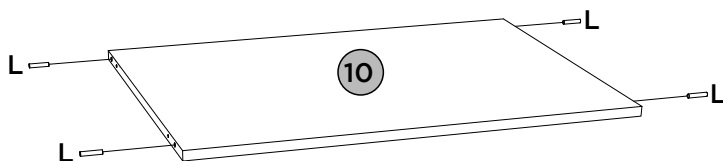
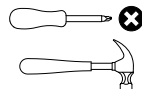

Fixar as corredeiras nessas furações

Fijar las dispositivos de estos agujeros
Fix the slides in these holes

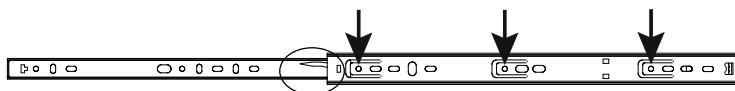

Para a desmontagem da corredeira, siga a instrução ao lado

Para el desmontaje de la diapositiva, siga las instrucciones en el lado

For disassembly of the slide, follow the instruction on the side

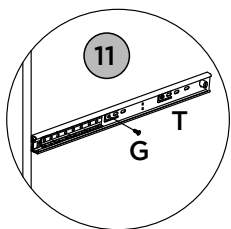
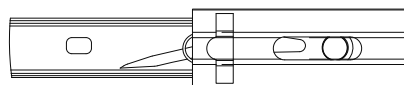
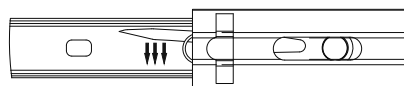



PASSO 4

ITM/I720-

PEÇAS REQUERIDAS

1	PÉ	x4
2	TRAVESSA DO RODAPÉ	x2

ACESSÓRIOS REQUERIDOS

AD			08
----	---	---	----

FERRAMENTAS NECESSÁRIAS

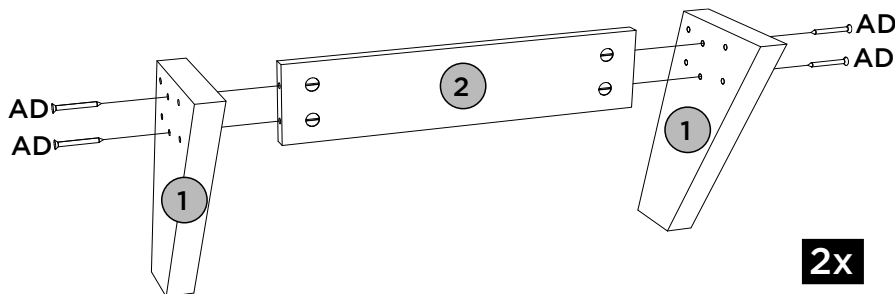
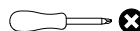

PASSO 5

PEÇAS REQUERIDAS

3	RODAPÉ FRONTAL	x1
4	RODAPÉ TRASEIRO	x1

ACESSÓRIOS REQUERIDOS

J			08
---	---	---	----



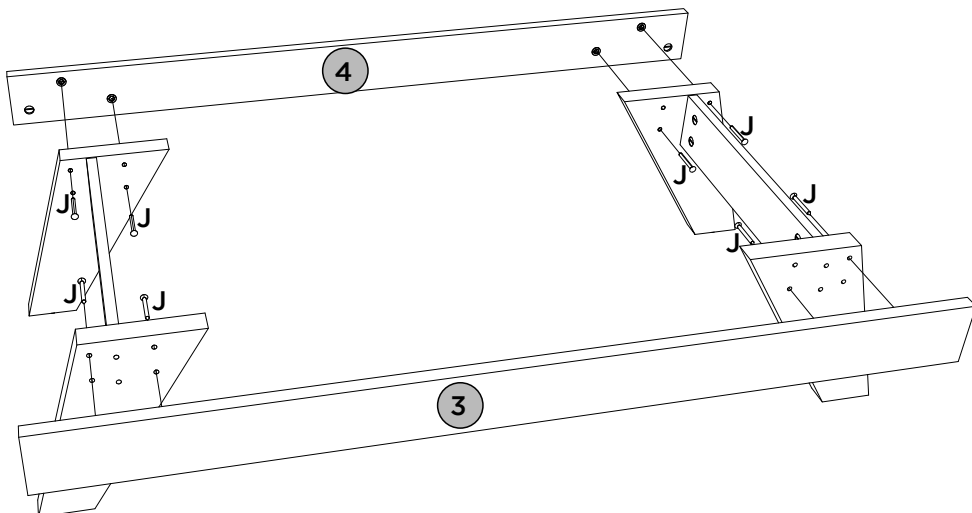
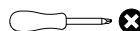

FERRAMENTAS NECESSÁRIAS



PEÇAS REQUERIDAS

5	LATERAL ESQUERDA	x1
6	BASE	x1
7	PÉ CENTRAL	x1

ACESSÓRIOS REQUERIDOS

B		02
C		03
F		04
M		02

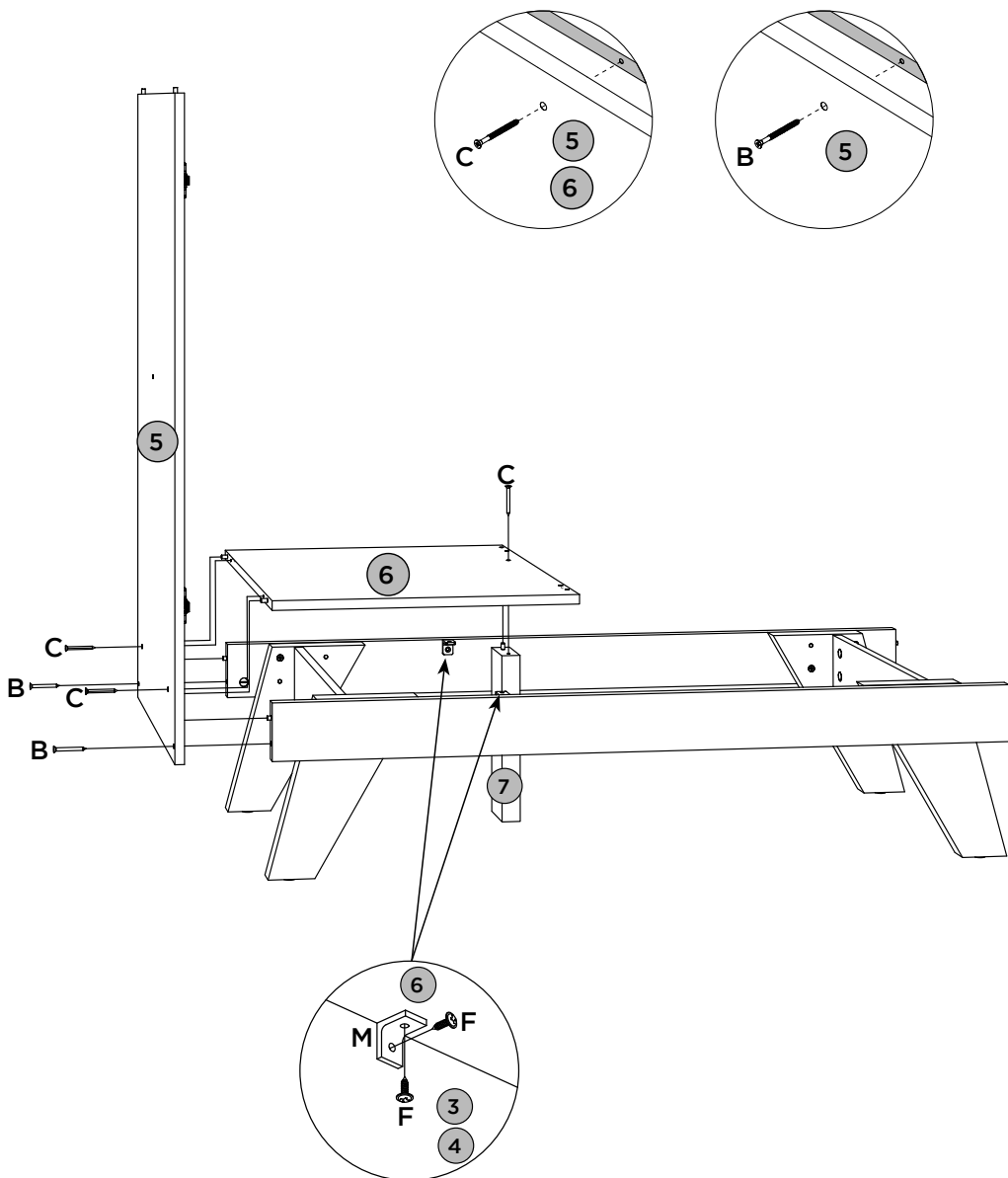
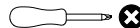
FERRAMENTAS NECESSÁRIAS

PEÇAS REQUERIDAS

8	DIVISÃO	x1
9	PRATELEIRA FIXA	x1

ACESSÓRIOS REQUERIDOS

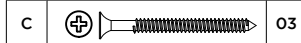

FERRAMENTAS NECESSÁRIAS

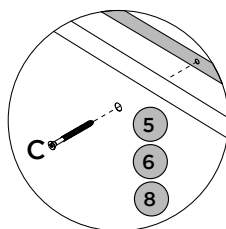
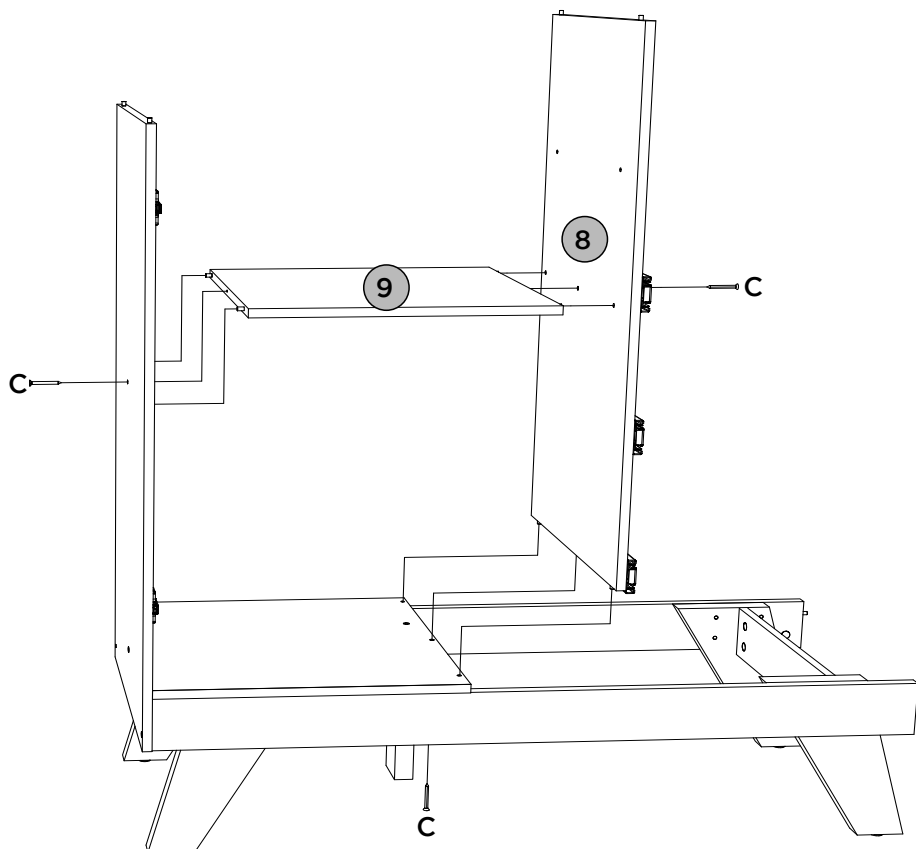
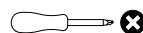



PASSO 8

ITM/1720-

PEÇAS REQUERIDAS

10	TAMPO DAS GAVETAS	x1
11	LATERAL DIREITA	x1

ACESSÓRIOS REQUERIDOS

B		02
C		04

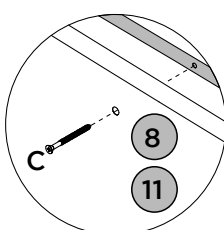
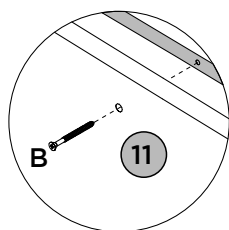
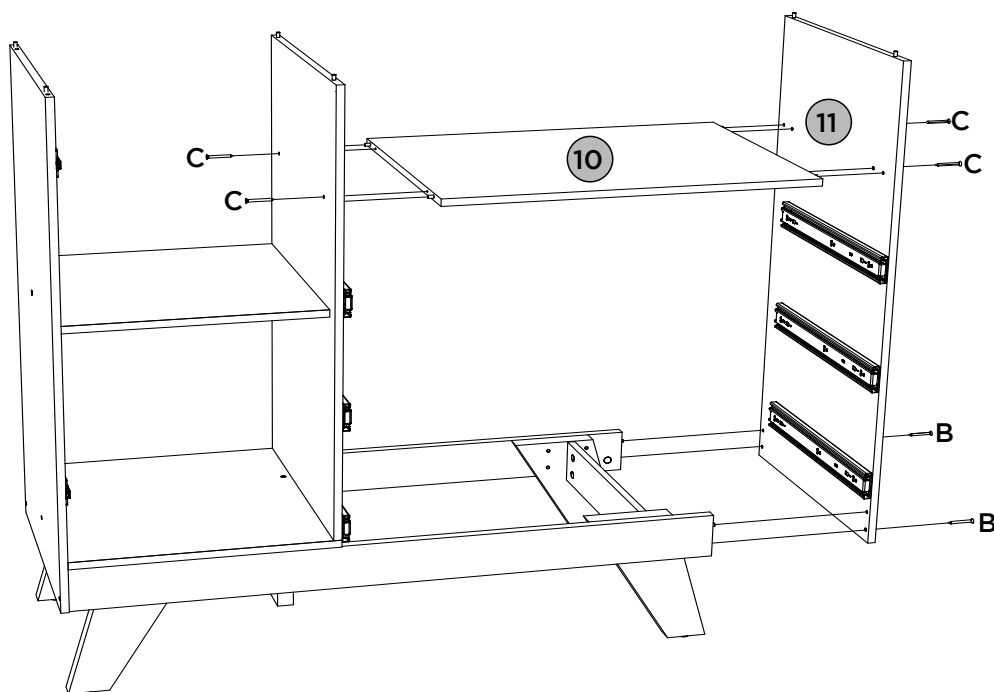
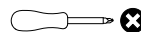

FERRAMENTAS NECESSÁRIAS



PEÇAS REQUERIDAS

12	TAMPO	x1
13	MOLDURA LATERAL	x2
14	MOLDURA SUPERIOR	x1

ACESSÓRIOS REQUERIDOS

C		07
L		02

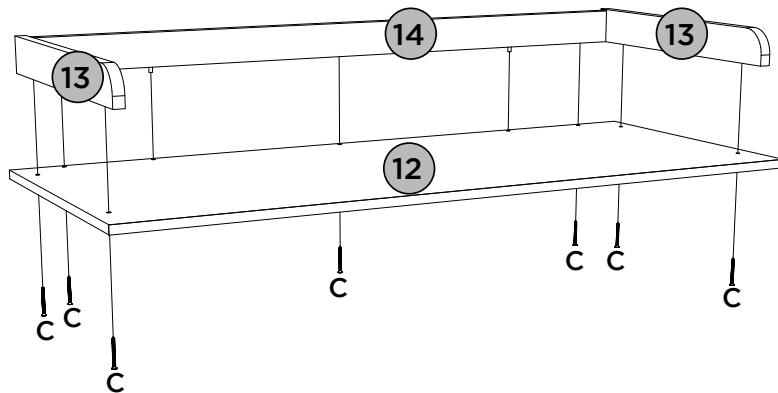
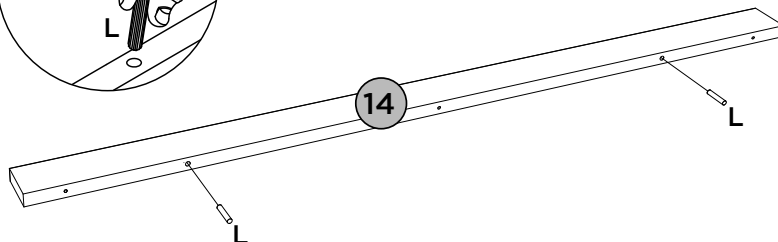
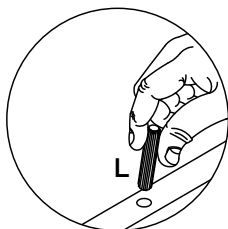
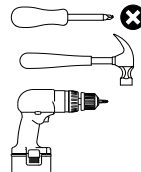
FERRAMENTAS NECESSÁRIAS



PARA COLOCAÇÃO DAS MOLDURAS NO TAMPO, É NECESSÁRIO FAZER A FURAÇÃO PASSANTE COM BROCA DE 5MM, UTILIZANDO COMO BASE AS PRÉ FURAÇÕES EXISTENTES NA PEÇA (12).

PARA COLOCAR LOS MARCOS EN LA PARTE SUPERIOR ES NECESARIO REALIZAR EL PERFORADO PASANTE CON TALADRO DE 5MM, UTILIZANDO COMO BASE LOS PRETALADRADOS EXISTENTES EN LA PIEZA (12).

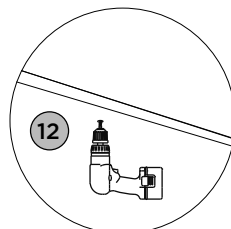
TO PLACE THE FRAMES ON THE TOP, IT IS NECESSARY TO MAKE THE THROUGH DRILLING WITH A 5MM DRILL, USING AS A BASE THE EXISTING PRE DRILLINGS IN THE PART (12).

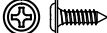

ACESSÓRIOS REQUERIDOS

F		10
M		05

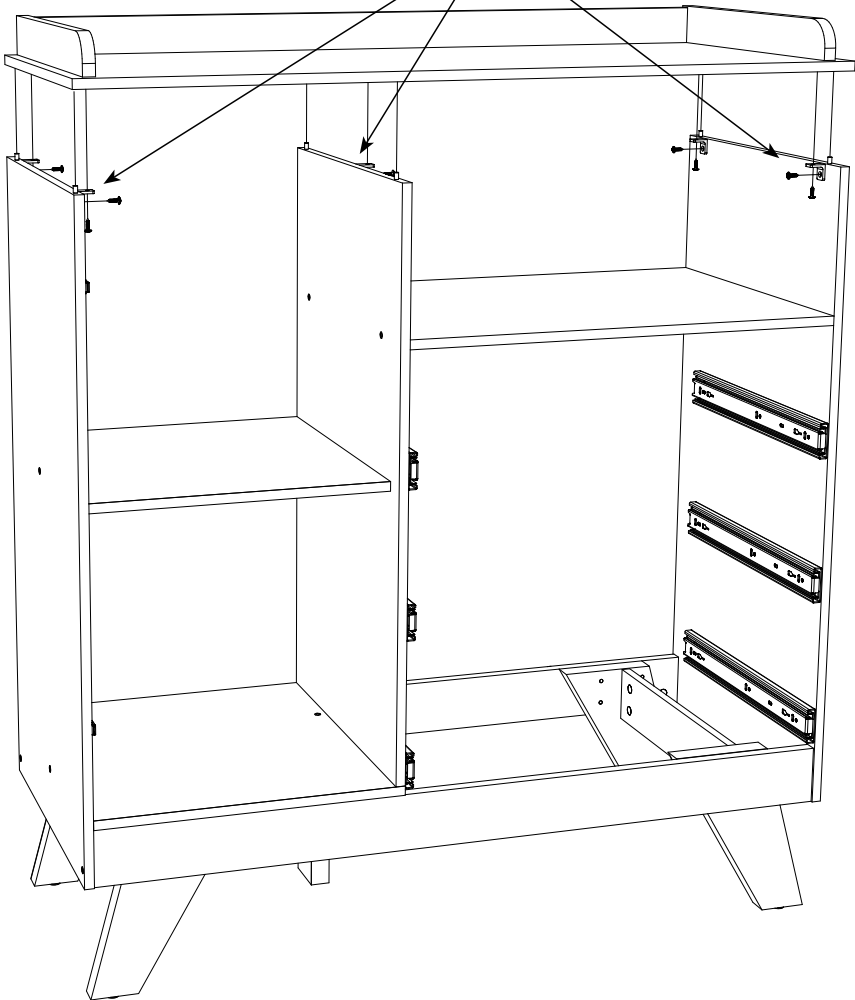
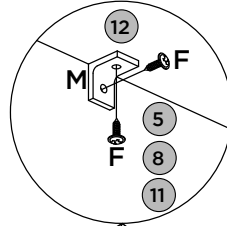
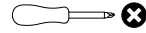

FERRAMENTAS NECESSÁRIAS



PEÇAS REQUERIDAS

15	FUNDO MAIOR	x1
16	FUNDO MENOR	x1
17	FUNDO	x2

ACESSÓRIOS REQUERIDOS

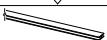
I		50
N		10
U		01

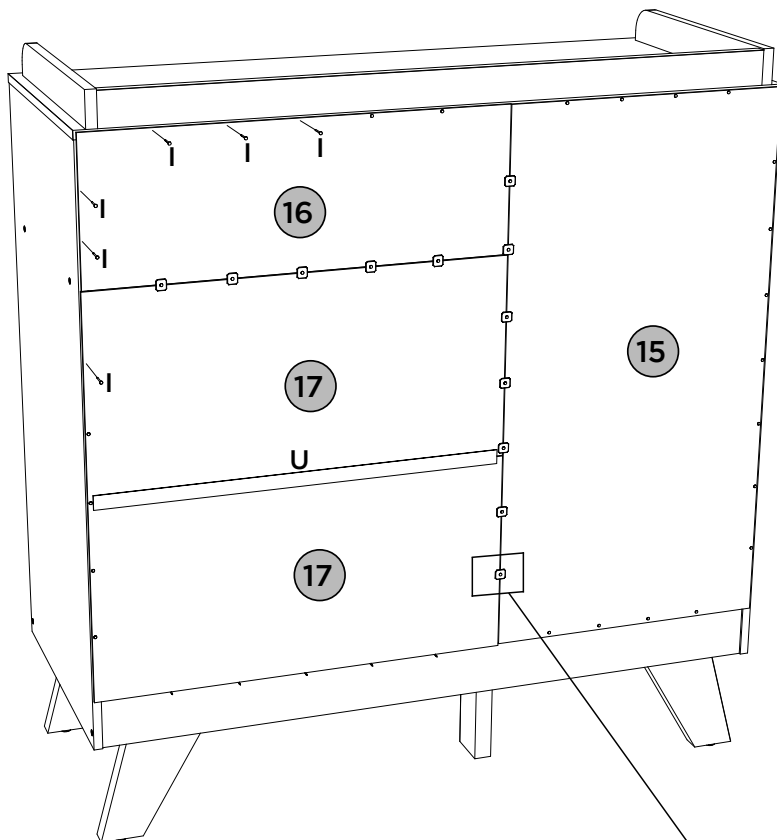
FERRAMENTAS NECESSÁRIAS

Fixar os pregos a uma distância de 120mm de um para outro.

Fijar las uñas a un distancia de 120mm uno a otro.



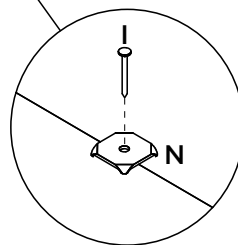

Fix the nails at a distance of 120mm from one to the other



PEÇAS REQUERIDAS

18	PORTA	x1
----	-------	----

ACESSÓRIOS REQUERIDOS

D		01
F		04
Q		01
S		02

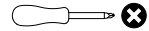
FERRAMENTAS NECESSÁRIAS

Vídeo: Instalar e regular Dobradiças

Video: Instale y ajuste las bisagras

Video: Install and adjust hinges

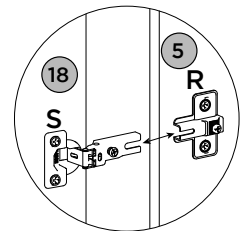
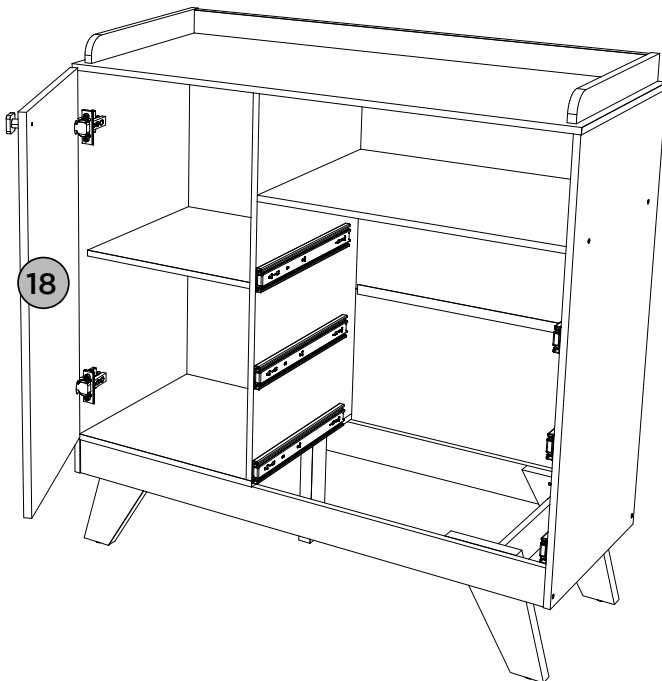
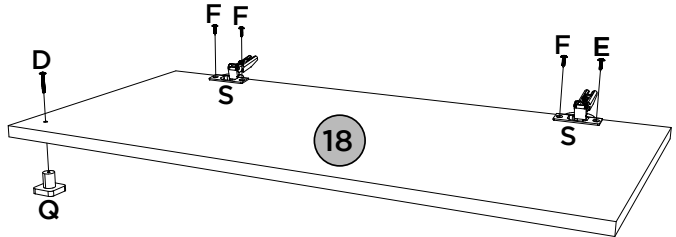
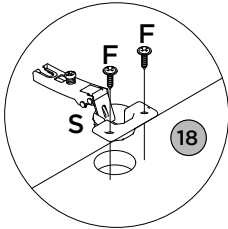





PASSO 13

ITM/1720-

PEÇAS REQUERIDAS

20	LADO DE GAVETA	x6
22	FRENTE DE GAVETA	x3

ACESSÓRIOS REQUERIDOS

D		03
L		24
Q		03
X		

FERRAMENTAS NECESSÁRIAS

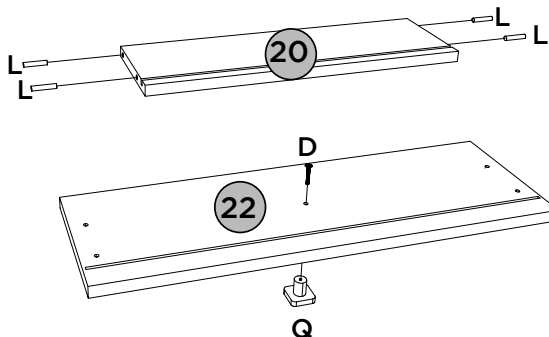
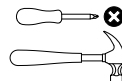

PASSO 14

PEÇAS REQUERIDAS

19	RIPA DE TRÁS	x3
20	LADO DE GAVETA	x6

ACESSÓRIOS REQUERIDOS

X		
---	---	--

FERRAMENTAS NECESSÁRIAS

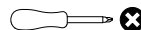

3x

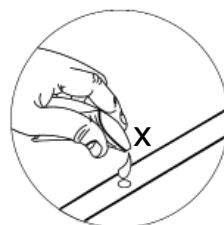
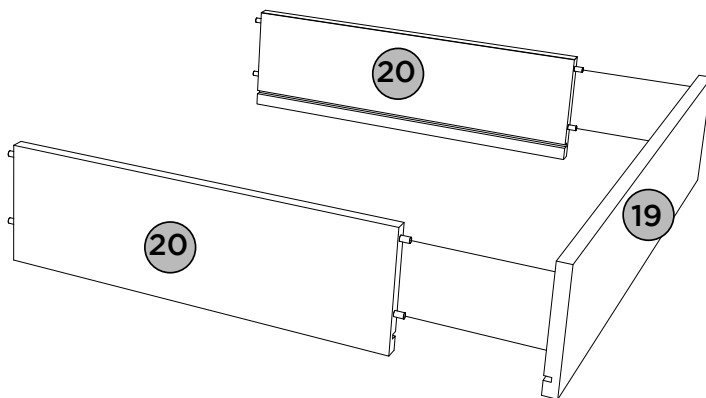

1º



PEÇAS REQUERIDAS

21	FUNDO DE GAVETA	x3
22	FRENTE DE GAVETA	x3

ACESSÓRIOS REQUERIDOS



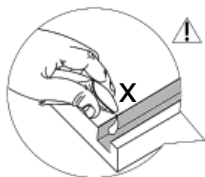
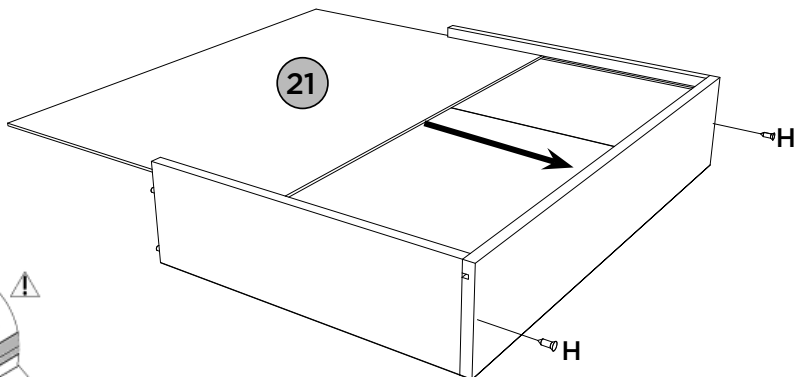
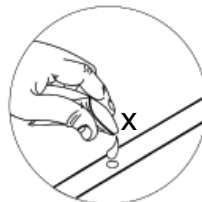
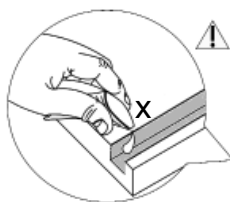
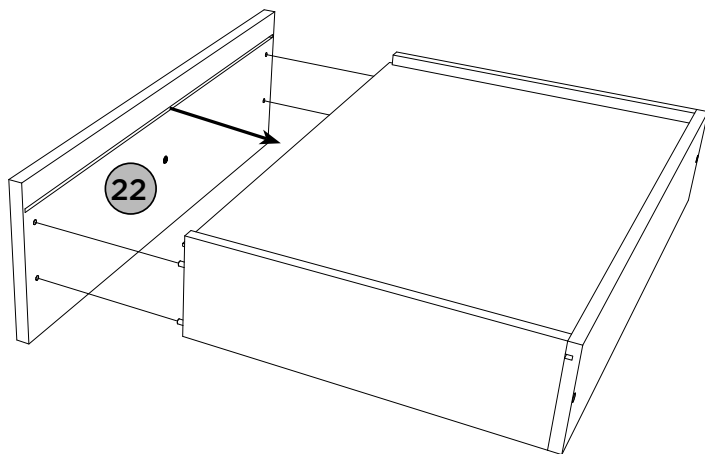

H		06
X		

FERRAMENTAS NECESSÁRIAS

3x
2º

3x
3º

ACESSÓRIOS REQUERIDOS

FERRAMENTAS NECESSÁRIAS

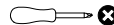
E		06
G		30
M		06
O		06
T		03



3x

4º

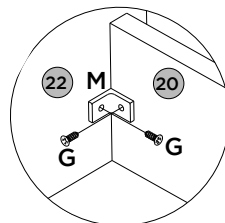
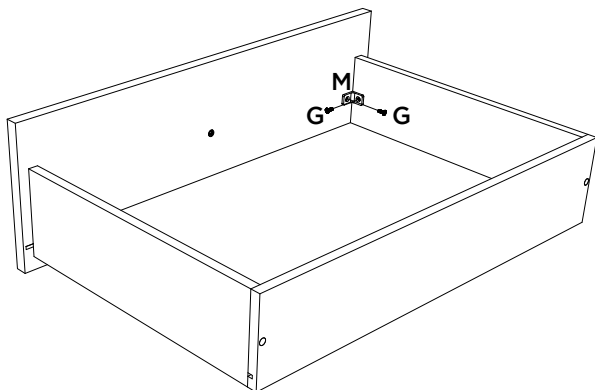





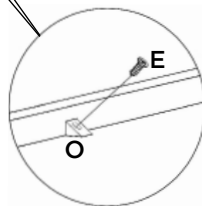
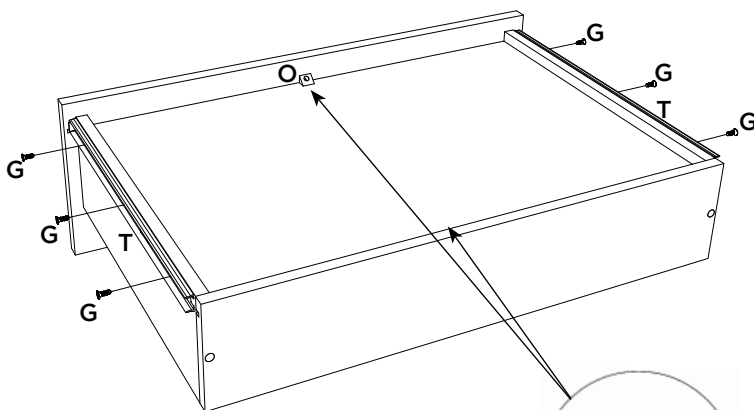

3x

5º



ACESSÓRIOS REQUERIDOS

A		01
F		02
V		01
W		01
Y		12
Z		02
AA	HENN	01

FERRAMENTAS NECESSÁRIAS



Para parede: Ajustar no modo perfuração
Para peça (8): Usar torque 5

Pesos máximos recomendados com carga distribuída
Peso máximo recomendado con la carga distribuida
Recommended maximum weight with distributed load.

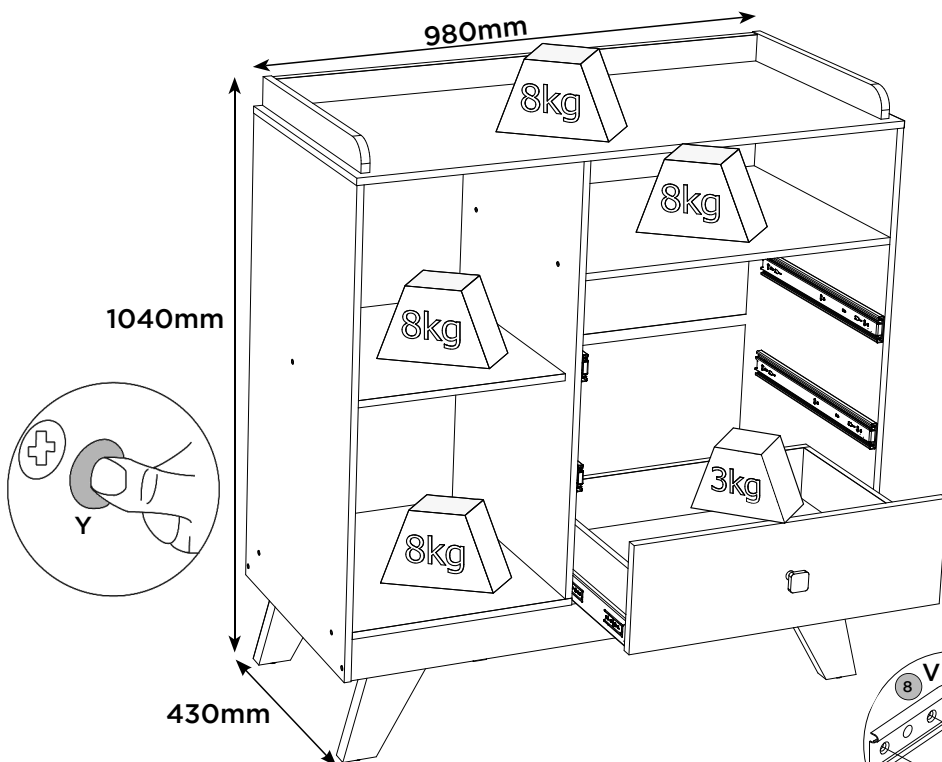

Imprescindível a fixação do produto na parede, a não colocação destas ferragens para fixação (A, F, V e W), poderá permitir que o produto vire, causando acidente.

Es imprescindible la fijación del producto en la pared, la no colocación de estos herrajes para fijación (A, F, V y W), podrá permitir que el El producto se vuelva, causando accidente.

Indispensable to fix the product on the wall, not the placement of these attachment fittings (A, F, V and W) may allow the product to turn, causing an accident.

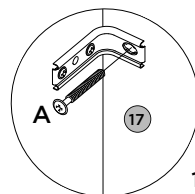
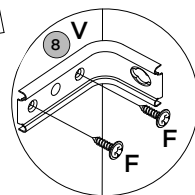

Produto Concluído
Producto terminado
Finished Product

