

# INSTRUÇÕES DE USO INSTRUCTIONS FOR USE INSTRUCCIONES DE USO

**REF.: 3715.1.10BA/3715.1.10CI/ 3715.1.10M/3715.1.10N  
3715.1.10MBA/3715.1.10NBA/3715.1.10NCI Cômoda Wave 3 gav**

**Lot: 12.801**



**DIVICAR**<sup>®</sup>  
projetando o futuro

DIVICAR MÓVEIS LTDA

Av. Júlio Vanzin, 720, - Bairro: Área Industrial III, - Cep. 95300-000  
Fone/fax: 55 54 3358 1062 - Lagoa Vermelha - Rio Grande do Sul - Brasil  
CNPJ: 73.638.470/0001-59 IE: 071/0039654  
E-mail: [divicar@divicar.com.br](mailto:divicar@divicar.com.br) - Site: [www.divicar.com.br](http://www.divicar.com.br)

# REF.: 3715.1.10BA Cômoda Wave 3 gav/Corpo:BA Gavetas:BA

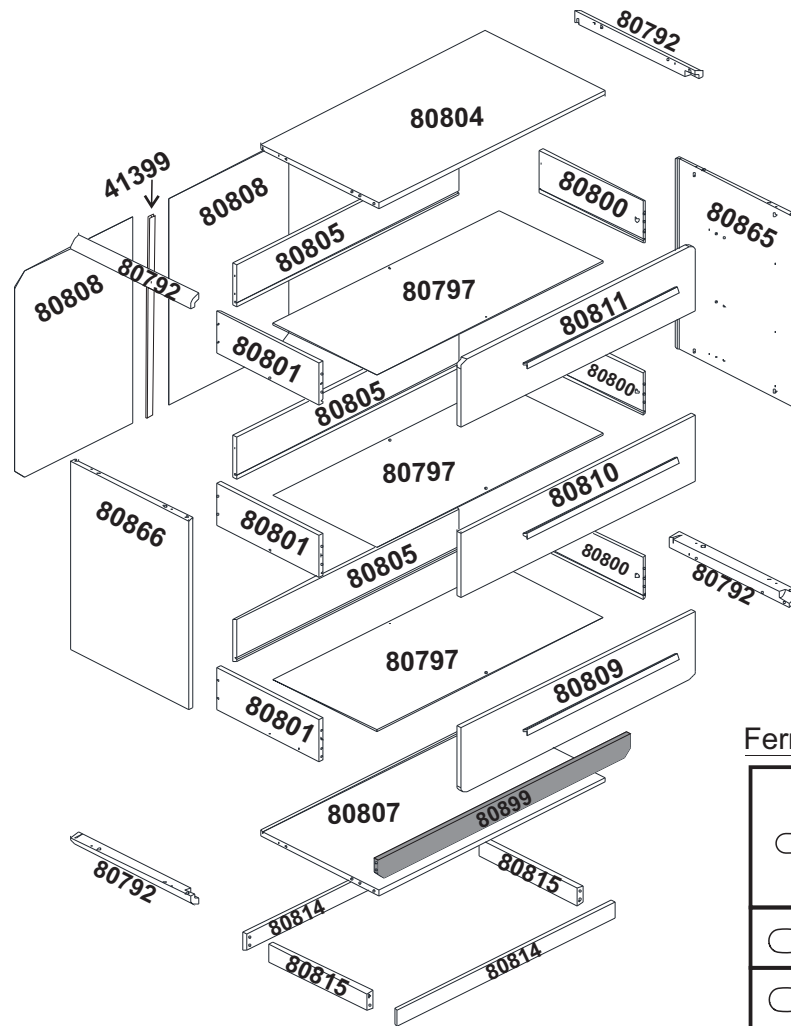

## Ferramentas/tools/instrumentos

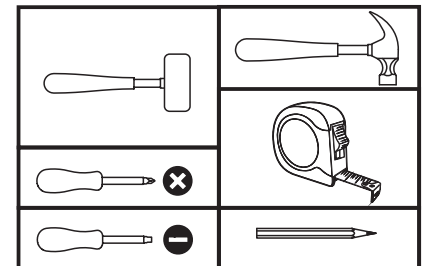

## LISTA DE PEÇAS/LIST OF PIECES/LISTA DE PIEZAS

Código/code Codigo	Legenda Subtitle Subtitular	Descrição/description/descripción	Quantidade/quantity/cantidad	Caixa/carton/caja
80792	A1	Montante curvo direito/right curved corner/esquina curva derecha	4	2/2
80797	B1	Fundo de gaveta/drawer bottom/fondo del cajón	3	1/2
80800	C1	Lateral gav. dir./right drawer side/lado derecho del cajón	3	2/2
80801	D1	Lateral gav. esq./left drawer side/lado izquierdo del cajón	3	2/2
80804	E1	Tampo/top panel/panel superior	1	1/2
80805	F1	Traseiro de gaveta/drawer back/parte trasera del cajón	3	1/2
80807	G1	Base inferior/bottom base/base inferior	1	1/2
80808	H1	Costa da comoda/product fund/fondo de producto	2	2/2
80809	I1	Frontal de gav. inf./bottom drawer front/frente del cajón inferior	1	1/2
80810	J1	Frontal de gav. central/central drawer front/frente del cajón central	1	1/2
80811	K1	Frontal de gav. sup./top drawer front/frente del cajón superior	1	1/2
80812	L1	Lateral direita/right side/lado derecho	1	2/2
80813	M1	Lateral esquerda/left side/lado izquierdo	1	2/2
80814	N1	Rodapé frontal/front horizontal support/soporte horizontal delantero	2	1/2
80815	O1	Rodapé lateral/side support/soporte lateral	2	1/2
41399	P1	Perfil I 714mm/profile I/perfil I	1	1/2
41518	Q1	Trilho telescópico 350mm/Telescopic rail/carril telescópico	3	2/2
80899	R1	Travessa Inferior/ lower crossbar/travesaño inferior	1	1/2

# REF.: 3715.1.10CI Cômoda Wave 3 gav/Corpo:CI Gavetas:CI

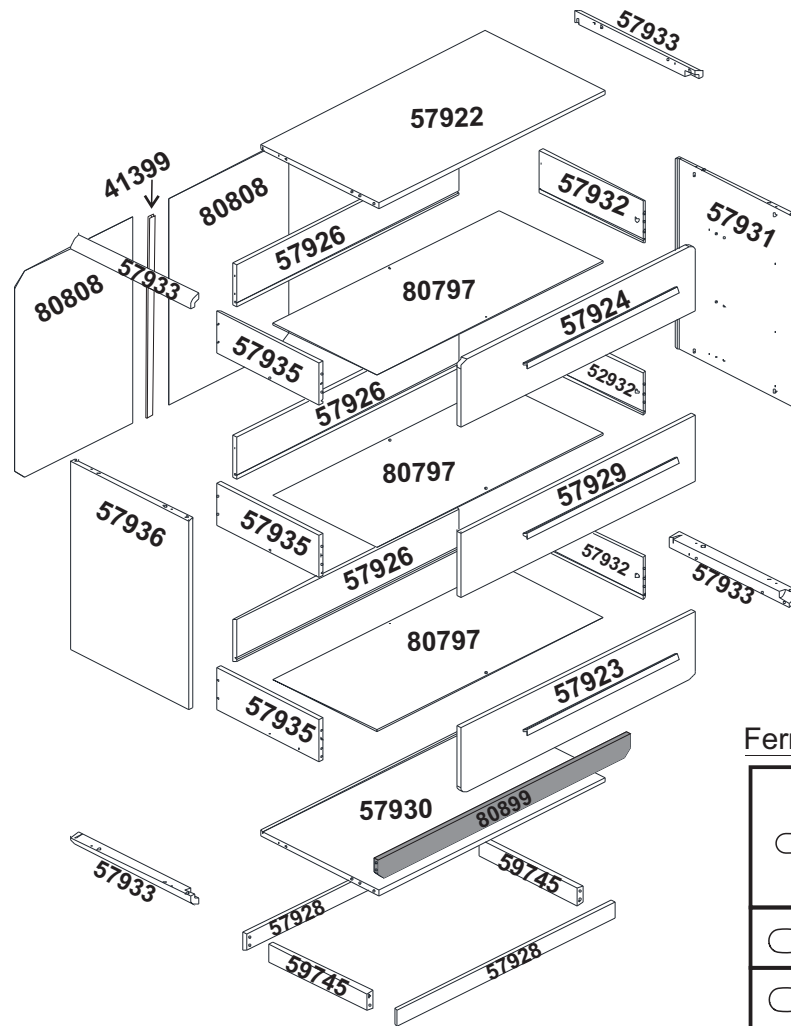

## Ferramentas/tools/instrumentos

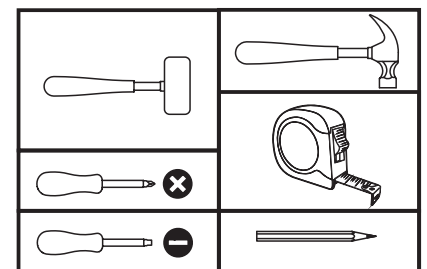

## LISTA DE PEÇAS/LIST OF PIECES/LISTA DE PIEZAS

Código/code Codigo	Legenda Subtitle Subtitular	Descrição/description/descripción	Quantidade/quantity/cantidad	Caixa/carton/caja
57933	A2	Montante curvo direito/right curved corner/esquina curva derecha	4	2/2
80797	B1	Fundo de gaveta/drawer bottom/fondo del cajón	3	1/2
57932	C2	Lateral gav. dir./right drawer side/lado derecho del cajón	3	2/2
57935	D2	Lateral gav. esq./left drawer side/lado izquierdo del cajón	3	2/2
57922	E2	Tampo/top panel/panel superior	1	1/2
57926	F2	Traseiro de gaveta/drawer back/parte trasera del cajón	3	1/2
57930	G2	Base inferior/bottom base/base inferior	1	1/2
80808	H1	Costa da comoda/product fund/fondo de producto	2	2/2
57923	I2	Frontal de gav. inf./bottom drawer front/frente del cajón inferior	1	1/2
57929	J2	Frontal de gav. central/central drawer front/frente del cajón central	1	1/2
57924	K2	Frontal de gav. sup./top drawer front/frente del cajón superior	1	1/2
57931	L2	Lateral direita/right side/lado derecho	1	2/2
57936	M2	Lateral esquerda/left side/lado izquierdo	1	2/2
57928	N2	Rodapé frontal/front horizontal support/soporte horizontal delantero	2	1/2
59745	O2	Rodapé lateral/side support/soporte lateral	2	1/2
41399	P1	Perfil I 714mm/profile I/perfil I	1	1/2
41518	Q1	Trilho telescópico 350mm/Telescopic rail/carril telescópico	3	2/2
80899	R1	Travessa Inferior/ lower crossbar/travesaño inferior	1	1/2

# REF.: 3715.1.10M Cômada Wave 3 gav/Corpo:M Gavetas:M

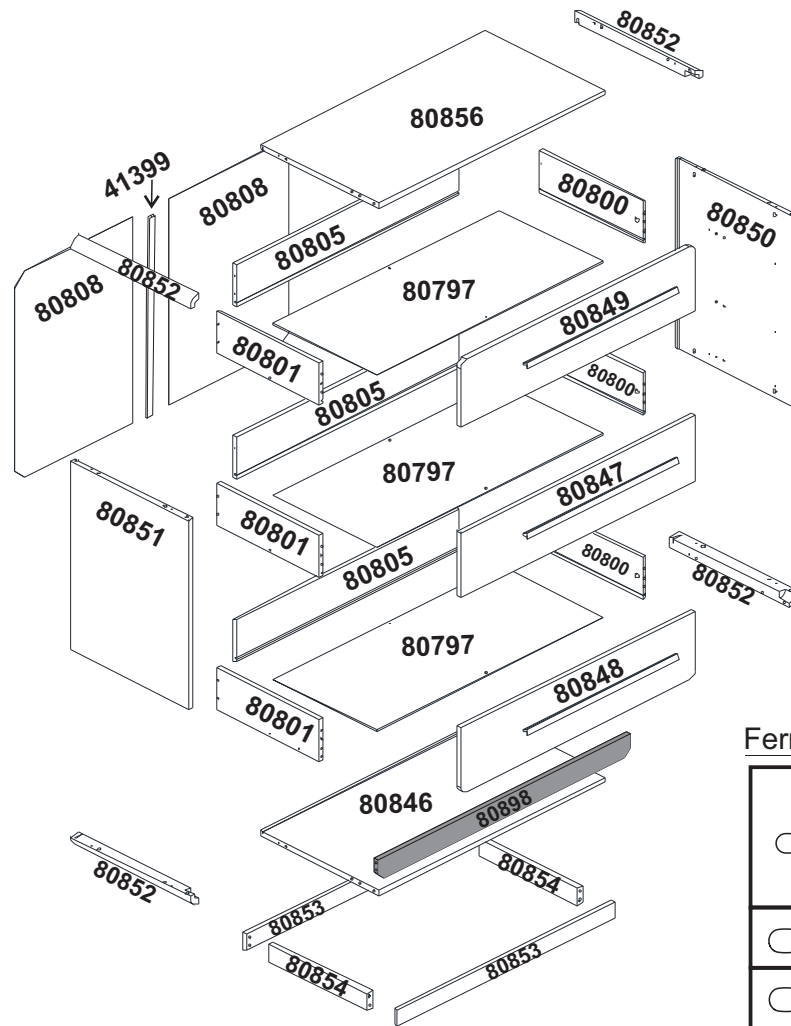

## Ferramentas/tools/instrumentos

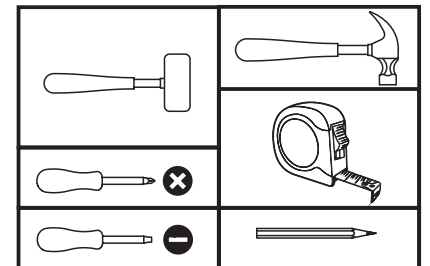

## LISTA DE PEÇAS/LIST OF PIECES/LISTA DE PIEZAS

Código/code Codigo	Legenda Subtitle Subtitular	Descrição/description/descripción	Quantidade/quantity/cantidad	Caixa/carton/caja
80852	A3	Montante curvo direito/right curved corner/esquina curva derecha	4	2/2
80797	B1	Fundo de gaveta/drawer bottom/fondo del cajón	3	1/2
80800	C1	Lateral gav. dir./right drawer side/lado derecho del cajón	3	2/2
80801	D1	Lateral gav. esq./left drawer side/lado izquierdo del cajón	3	2/2
80856	E3	Tampo/top panel/panel superior	1	1/2
80805	F1	Traseiro de gaveta/drawer back/parte trasera del cajón	3	1/2
80846	G3	Base inferior/bottom base/base inferior	1	1/2
80808	H1	Costa da comoda/product fund/fondo de producto	2	2/2
80848	I3	Frontal de gav. inf./bottom drawer front/frente del cajón inferior	1	1/2
80847	J3	Frontal de gav. central/central drawer front/frente del cajón central	1	1/2
80849	K3	Frontal de gav. sup./top drawer front/frente del cajón superior	1	1/2
80850	L3	Lateral direita/right side/lado derecho	1	2/2
80851	M3	Lateral esquerda/left side/lado izquierdo	1	2/2
80853	N3	Rodapé frontal/front horizontal support/soporte horizontal delantero	2	1/2
80854	O3	Rodapé lateral/side support/soporte lateral	2	1/2
41399	P1	Perfil I 714mm/profile I/perfil I	1	1/2
41518	Q1	Trilho telescópico 350mm/Telescopic rail/carril telescópico	3	2/2
80898	R2	Travessa Inferior/ lower crossbar/travesaño inferior	1	1/2

# REF.: 3715.1.10MBA Cômoda Wave 3 gav/Corpo:M Gavetas:BA

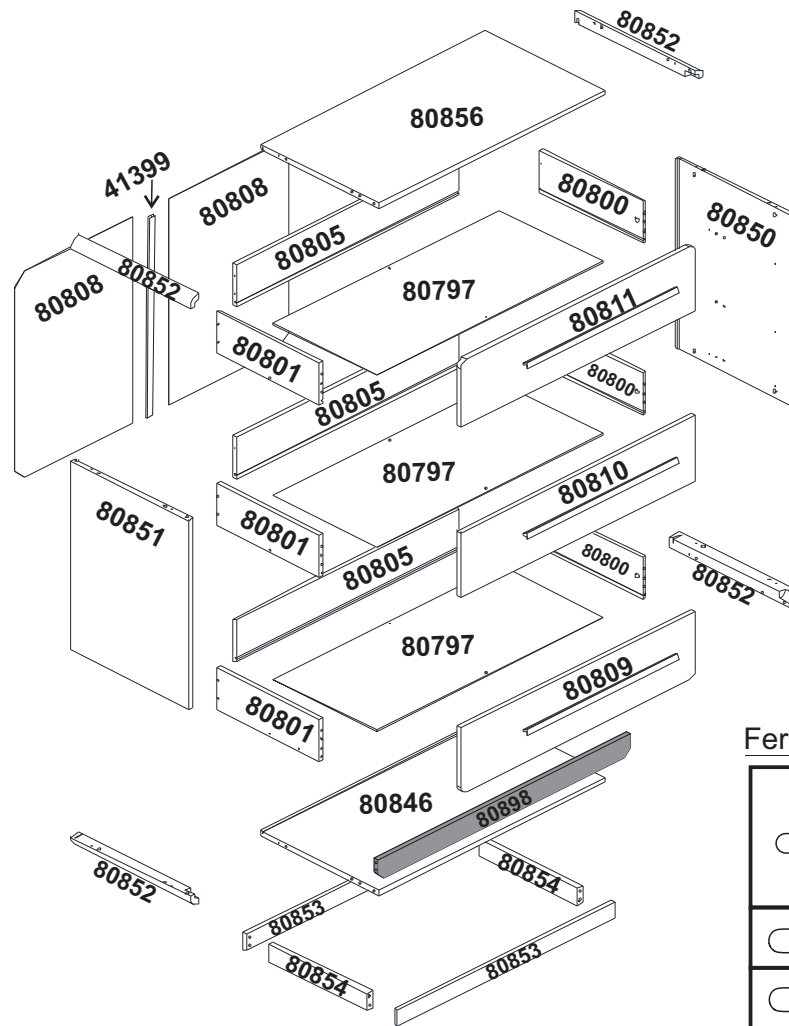

## Ferramentas/tools/instrumentos

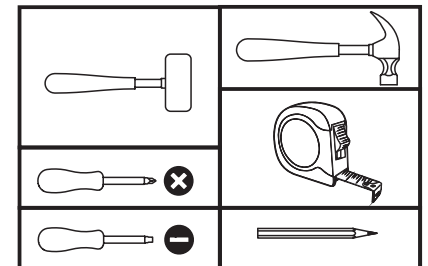

## LISTA DE PEÇAS/LIST OF PIECES/LISTA DE PIEZAS

Código/code Codigo	Legenda Subtitle Subtitular	Descrição/description/descripción	Quantidade/quantity/cantidad	Caixa/carton/caja
80852	A3	Montante curvo direito/right curved corner/esquina curva derecha	4	2/2
80797	B1	Fundo de gaveta/drawer bottom/fondo del cajón	3	1/2
80800	C1	Lateral gav. dir./right drawer side/lado derecho del cajón	3	2/2
80801	D1	Lateral gav. esq./left drawer side/lado izquierdo del cajón	3	2/2
80856	E3	Tampo/top panel/panel superior	1	1/2
80805	F1	Traseiro de gaveta/drawer back/parte trasera del cajón	3	1/2
80846	G3	Base inferior/bottom base/base inferior	1	1/2
80808	H1	Costa da comoda/product fund/fondo de producto	2	2/2
80809	I1	Frontal de gav. inf./bottom drawer front/frente del cajón inferior	1	1/2
80810	J1	Frontal de gav. central/central drawer front/frente del cajón central	1	1/2
80811	K1	Frontal de gav. sup./top drawer front/frente del cajón superior	1	1/2
80850	L3	Lateral direita/right side/lado derecho	1	2/2
80851	M3	Lateral esquerda/left side/lado izquierdo	1	2/2
80853	N3	Rodapé frontal/front horizontal support/soporte horizontal delantero	2	1/2
80854	O3	Rodapé lateral/side support/soporte lateral	2	1/2
41399	P1	Perfil I 714mm/profile I/perfil I	1	1/2
41518	Q1	Trilho telescópico 350mm/Telescopic rail/carril telescópico	3	2/2
80898	R2	Travessa Inferior/ lower crossbar/travesaño inferior	1	1/2

# REF.: 3715.1.10N Cômoda Wave 3 gav/Corpo: N Gavetas: N

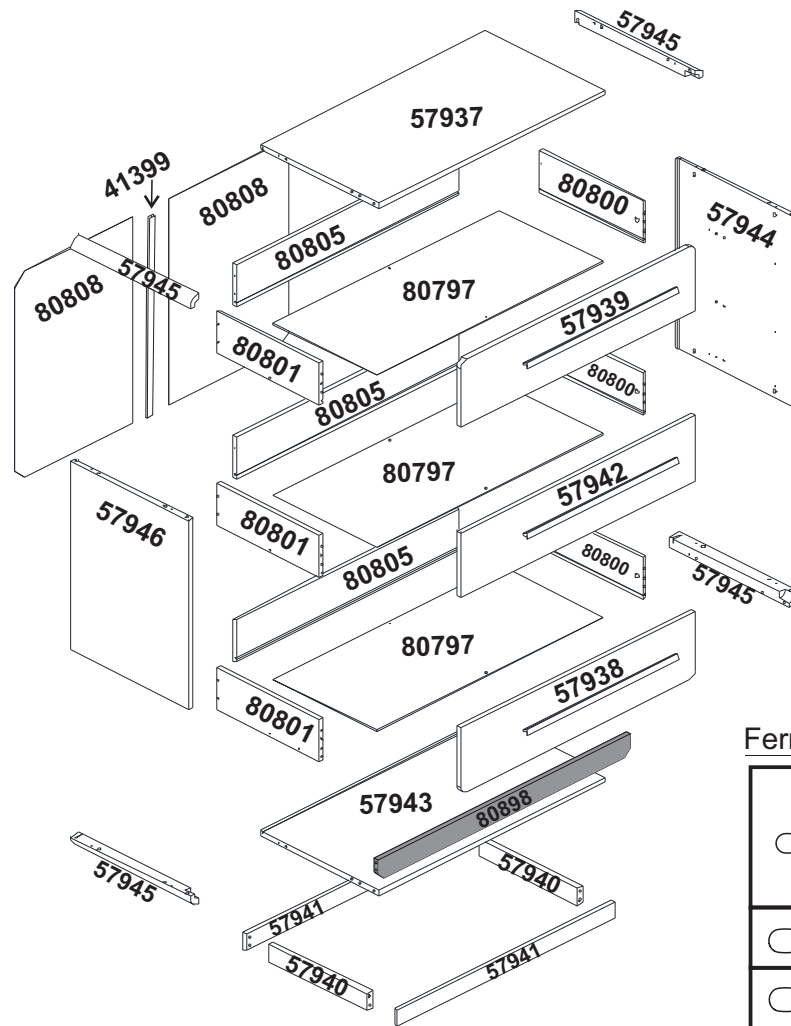

## Ferramentas/tools/instrumentos

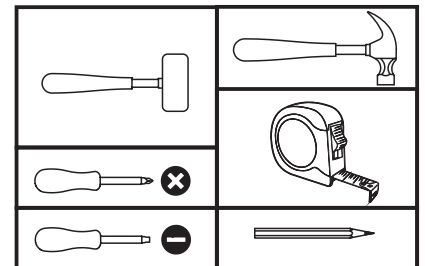

## LISTA DE PEÇAS/LIST OF PIECES/LISTA DE PIEZAS

Código/code Codigo	Legenda Subtitle Subtitular	Descrição/description/descripción	Quantidade/quantity/cantidad	Caixa/carton/caja
57945	A4	Montante curvo direito/right curved corner/esquina curva derecha	4	2/2
80797	B1	Fundo de gaveta/drawer bottom/fondo del cajón	3	1/2
80800	C1	Lateral gav. dir./right drawer side/lado derecho del cajón	3	2/2
80801	D1	Lateral gav. esq./left drawer side/lado izquierdo del cajón	3	2/2
57937	E4	Tampo/top panel/panel superior	1	1/2
80805	F1	Traseiro de gaveta/drawer back/parte trasera del cajón	3	1/2
57943	G4	Base inferior/bottom base/base inferior	1	1/2
80808	H1	Costa da comoda/product fund/fondo de producto	2	2/2
57938	I4	Frontal de gav. inf./bottom drawer front/frente del cajón inferior	1	1/2
57942	J4	Frontal de gav. central/central drawer front/frente del cajón central	1	1/2
57939	K4	Frontal de gav. sup./top drawer front/frente del cajón superior	1	1/2
57944	L4	Lateral direita/right side/lado derecho	1	2/2
57946	M4	Lateral esquerda/left side/lado izquierdo	1	2/2
57941	N4	Rodapé frontal/front horizontal support/soporte horizontal delantero	2	1/2
57940	O4	Rodapé lateral/side support/soporte lateral	2	1/2
41399	P1	Perfil I 714mm/profile I/perfil I	1	1/2
41518	Q1	Trilho telescópico 350mm/Telescopic rail/carril telescópico	3	2/2
80898	R2	Travessa Inferior/ lower crossbar/travesaño inferior	1	1/2



# REF.: 3715.1.10NBA Cômoda Wave 3 gav/Corpo: N Gavetas:BA

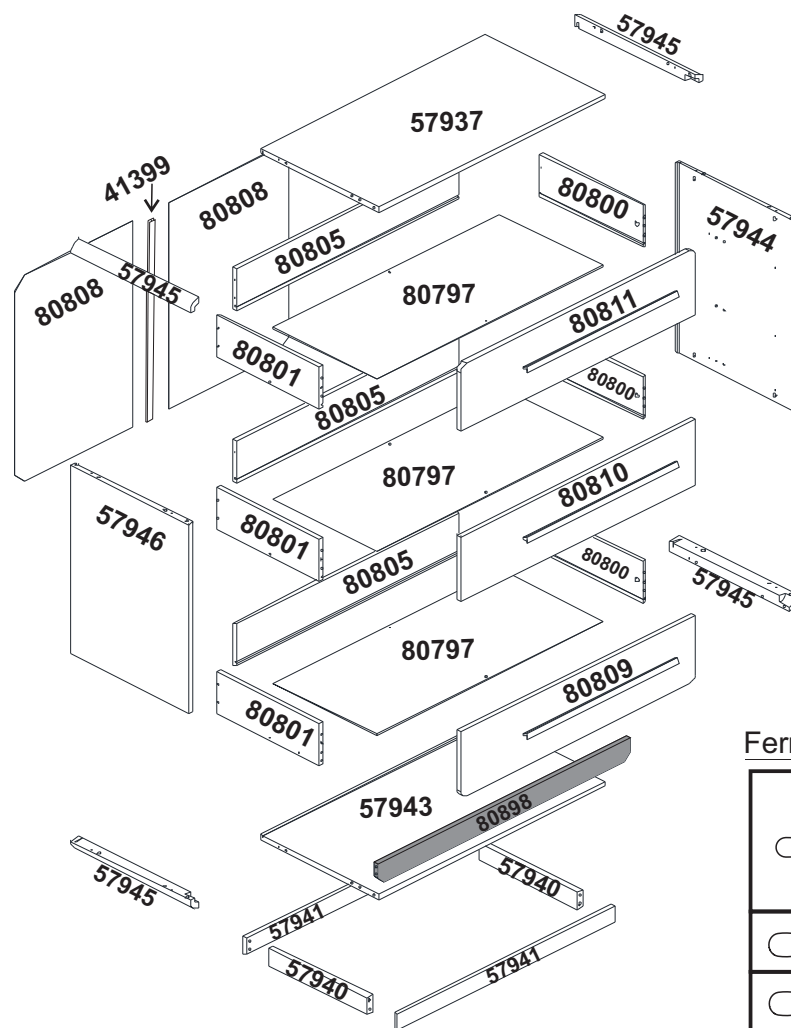

## Ferramentas/tools/instrumentos

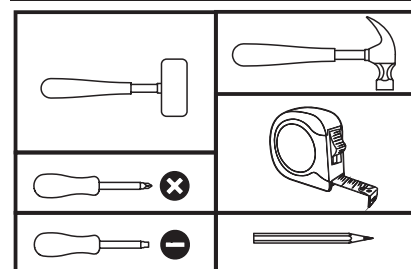

## LISTA DE PEÇAS/LIST OF PIECES/LISTA DE PIEZAS

Código/code Codigo	Legenda Subtitle Subtitular	Descrição/description/descripción	Quantidade/quantity/cantidad	Caixa/carton/caja
57945	A4	Montante curvo direito/right curved corner/esquina curva derecha	4	2/2
80797	B1	Fundo de gaveta/drawer bottom/fondo del cajón	3	1/2
80800	C1	Lateral gav. dir./right drawer side/lado derecho del cajón	3	2/2
80801	D1	Lateral gav. esq./left drawer side/lado izquierdo del cajón	3	2/2
57937	E4	Tampo/top panel/panel superior	1	1/2
80805	F1	Traseiro de gaveta/drawer back/parte trasera del cajón	3	1/2
57943	G4	Base inferior/bottom base/base inferior	1	1/2
80808	H1	Costa da comoda/product fund/fondo de producto	2	2/2
80809	I1	Frontal de gav. inf./bottom drawer front/frente del cajón inferior	1	1/2
80810	J1	Frontal de gav. central/central drawer front/frente del cajón central	1	1/2
80811	K1	Frontal de gav. sup./top drawer front/frente del cajón superior	1	1/2
57944	L4	Lateral direita/right side/lado derecho	1	2/2
57946	M4	Lateral esquerda/left side/lado izquierdo	1	2/2
57941	N4	Rodapé frontal/front horizontal support/soporte horizontal delantero	2	1/2
57940	O4	Rodapé lateral/side support/soporte lateral	2	1/2
41399	P1	Perfil I 714mm/profile I/perfil I	1	1/2
41518	Q1	Trilho telescópico 350mm/Telescopic rail/carril telescópico	3	2/2
80898	R2	Travessa Inferior/ lower crossbar/travesaño inferior	1	1/2

# REF.: 3715.1.10NCI Cômoda Wave 3 gav/Corpo: N Gavetas:CI

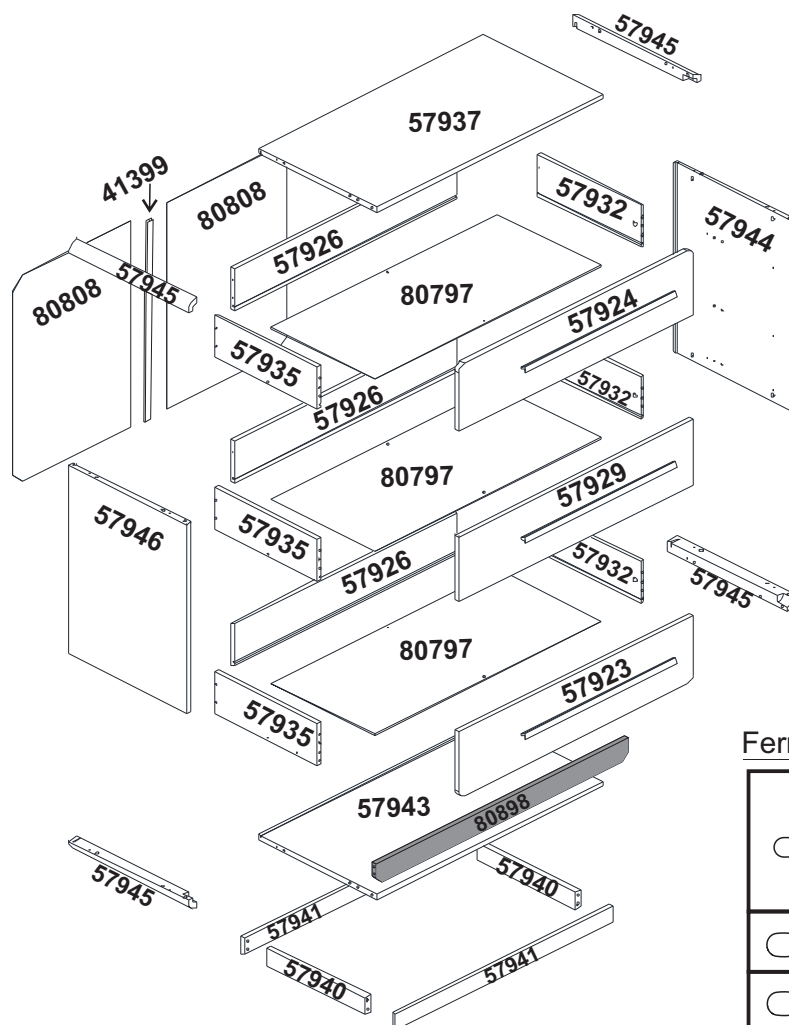

## Ferramentas/tools/instrumentos

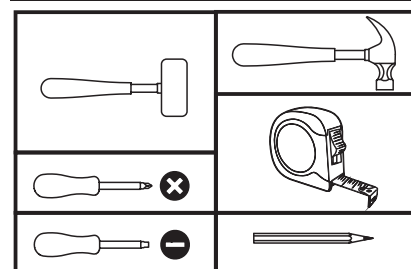











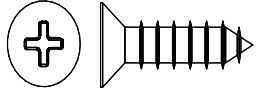
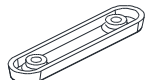

## LISTA DE PEÇAS/LIST OF PIECES/LISTA DE PIEZAS

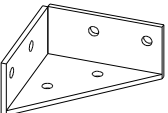
Código/code Codigo	Legenda Subtitle Subtitular	Descrição/description/descripción	Quantidade/quantity/cantidad	Caixa/carton/caja
57945	A4	Montante curvo direito/right curved corner/esquina curva derecha	4	2/2
80797	B1	Fundo de gaveta/drawer bottom/fondo del cajón	3	1/2
80800	C2	Lateral gav. dir./right drawer side/lado derecho del cajón	3	2/2
80801	D2	Lateral gav. esq./left drawer side/lado izquierdo del cajón	3	2/2
57937	E4	Tampo/top panel/panel superior	1	1/2
80805	F2	Traseiro de gaveta/drawer back/parte trasera del cajón	3	1/2
57943	G4	Base inferior/bottom base/base inferior	1	1/2
80808	H1	Costa da comoda/product fund/fondo de producto	2	2/2
57923	I2	Frontal de gav. inf./bottom drawer front/frente del cajón inferior	1	1/2
57929	J2	Frontal de gav. central/central drawer front/frente del cajón central	1	1/2
57924	K2	Frontal de gav. sup./top drawer front/frente del cajón superior	1	1/2
57944	L4	Lateral direita/right side/lado derecho	1	2/2
57946	M4	Lateral esquerda/left side/lado izquierdo	1	2/2
57941	N4	Rodapé frontal/front horizontal support/soporte horizontal delantero	2	1/2
57940	O4	Rodapé lateral/side support/soporte lateral	2	1/2
41399	P1	Perfil I 714mm/profile I/perfil I	1	1/2
41518	Q1	Trilho telescópico 350mm/Telescopic rail/carril telescópico	3	2/2
80898	R2	Travessa Inferior/ lower crossbar/travesaño inferior	1	1/2

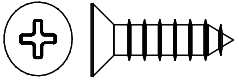

# LISTA DE ACESSÓRIOS/FITTINGS LIST/LISTA DE ACCESORIOS

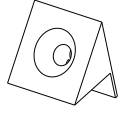
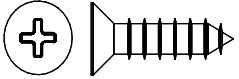
<b>A</b>  Cola Cola/glue/pegamento (2x)	<b>B</b>  Cavilha/dowel/clavija Ø8,0 x 30mm (46x)	<b>C</b>  Parafuso/screw/tornillo Ø4,0 x 16mm (24x)	<b>D</b>  Sapata/sliding foot for dresser/ Pie deslizante para tocador (6x)
<b>E</b>  Parafuso minifix/cam bolt/tornillo (24x)	<b>F</b>  Parafuso/screw/tornillo Ø 6,0x 12mm (18x)	<b>G</b>  Parafuso/screw/tornillo Ø4,0 x 40mm (12x)	<b>H</b>  Cantoneira com pino/ angle bracket with pin/ soporte angular con pasador (6x)
<b>I</b>  Cantoneira metálica/metal angle/ ángulo de metal (4x)	<b>J</b>  Tambor minifix/minifix drum/ tambor minifijo Ø15 x 11mm (24x)	<b>K</b>  Tapa-furo/Hole plugs/cubierta adhesiva Branco/white/blanco Ø18mm (06x)	<b>L</b>  Parafuso/screw/tornillo Ø3,5 x 14mm (30x)
<b>M</b>  Ø3,5x25 <b>02</b>  Arruela Washer Arandela de metal <b>02</b>  Anti-tip strap Correa de detención de caídas <b>01</b> <b>(1X)</b>		<b>N</b>  Cantoneira plástica/plastic corner/ esquina de plástico(8x)	<b>O</b>  Parafuso/screw/tornillo Ø3,5 x 12mm (18x)

\*Os puxadores devem ser adquiridos separadamente !  
 \*Handles must be purchased separately !  
 \*Las manijas deben comprarse por separado! !

## Puxadores da cômoda/dresser handles/manijas del tocador

Código/code Codigo	Descrição/description/descripción	Quantidade/quantity/cantidad	Caixa/carton/caja
3495.1.10CB	PUXADOR COMODA WAVE - KEN COR COBRE	3	1/1
3495.1.10D	PUXADOR COMODA WAVE - KEN COR DOURADO	3	1/1
3495.1.10PRT	PUXADOR COMODA WAVE - KEN COR PRETO	3	1/1

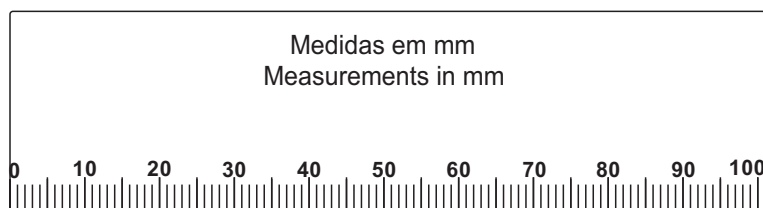

# PASSO 1

**PARTES REQUERIDAS**  
**PARTS REQUIRED**  
**PIEZAS NECESARIAS**

A1/A2/A3/A4-Montante curvo /curved corner/  
esquina curva x4

**FERRAGENS NECESSÁRIAS**

**HARDWARE REQUIRED**

**MATERIALES NECESARIOS**

E  16

**FERRAMENTAS NECESSÁRIAS**

**TOOLS REQUIRED**

**HERRAMIENTAS NECESARIAS**

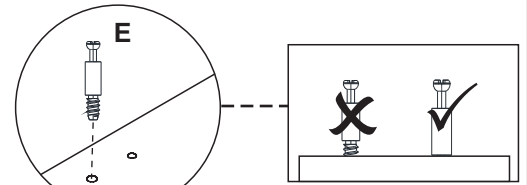
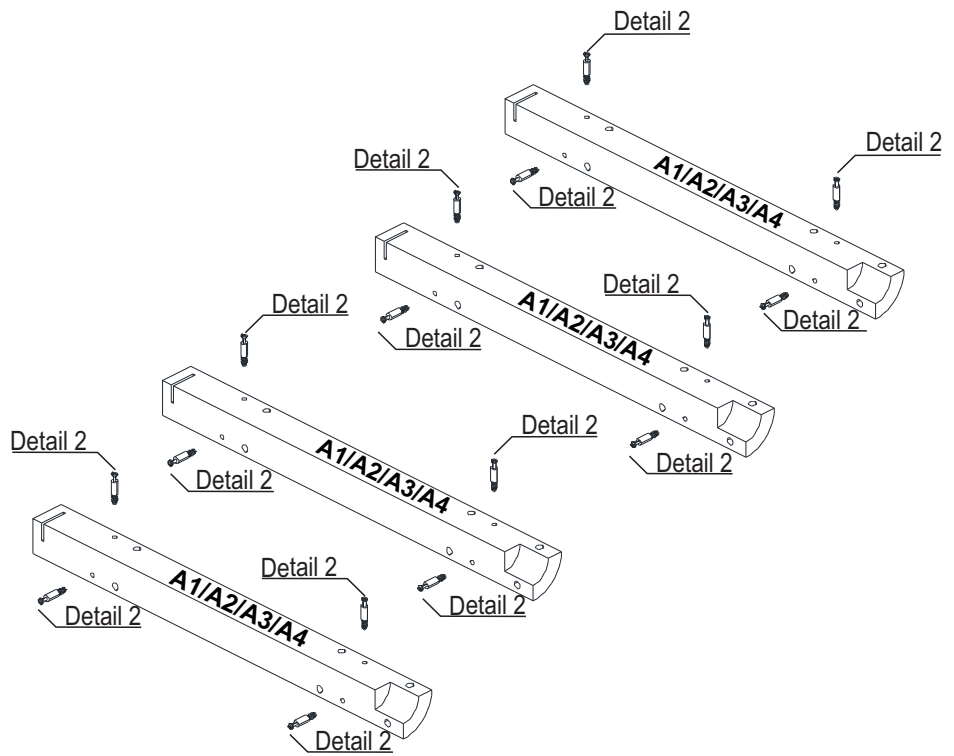
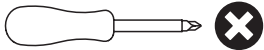

Detalhe 2

# PASSO 2

**PARTES REQUERIDAS**  
**PARTS REQUIRED**  
**PIEZAS NECESARIAS**

L1/L2/L3/L4-Lateral direita/  
right side/lado derecho x1

M1/M2/M3/M4- Lateral esquerda/  
left side/lado izquierdo x1

**FERRAGENS NECESSÁRIAS**

**HARDWARE REQUIRED**

**MATERIALES NECESARIOS**

A  01

B  12  
Ø 8,0 x 30mm

E  02

**FERRAMENTAS NECESSÁRIAS**

**TOOLS REQUIRED**

**HERRAMIENTAS NECESARIAS**

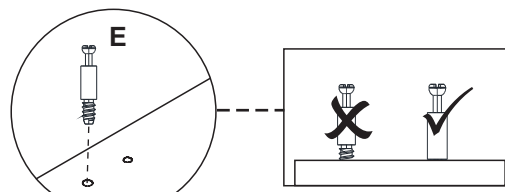
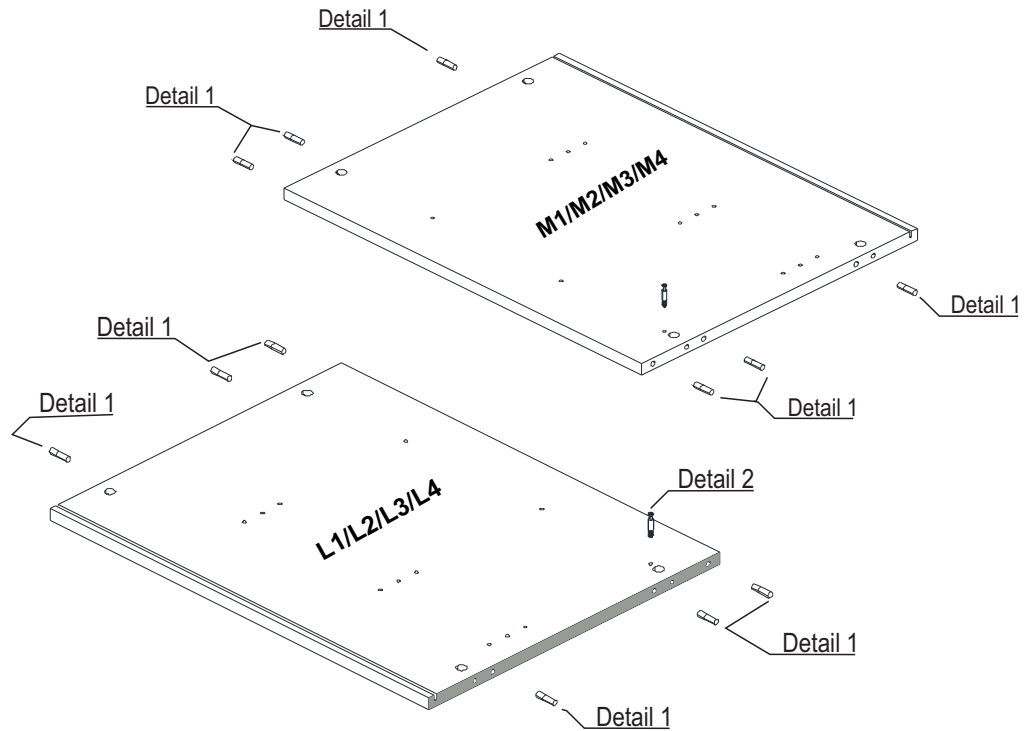
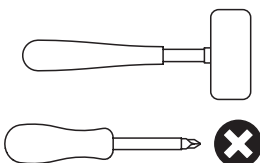

Detalhe 2

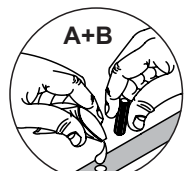

Detalhe 1

# PASSO 3

**PARTES REQUERIDAS**  
**PARTS REQUIRED**  
**PIEZAS NECESARIAS**

G1/G2/G3/G4-Base inferior/bottom base/  
 base inferior x1

R1/R2-Travessa Inferior/ lower crossbar/  
 lower crossbar/travesaño inferior x1

**FERRAGENS NECESSÁRIAS**

**HARDWARE REQUIRED**

**MATERIALES NECESARIOS**

A  01

B  08  
 Ø 8,0 x 30mm

**FERRAMENTAS NECESSÁRIAS**

**TOOLS REQUIRED**

**HERRAMIENTAS NECESARIAS**

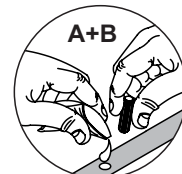
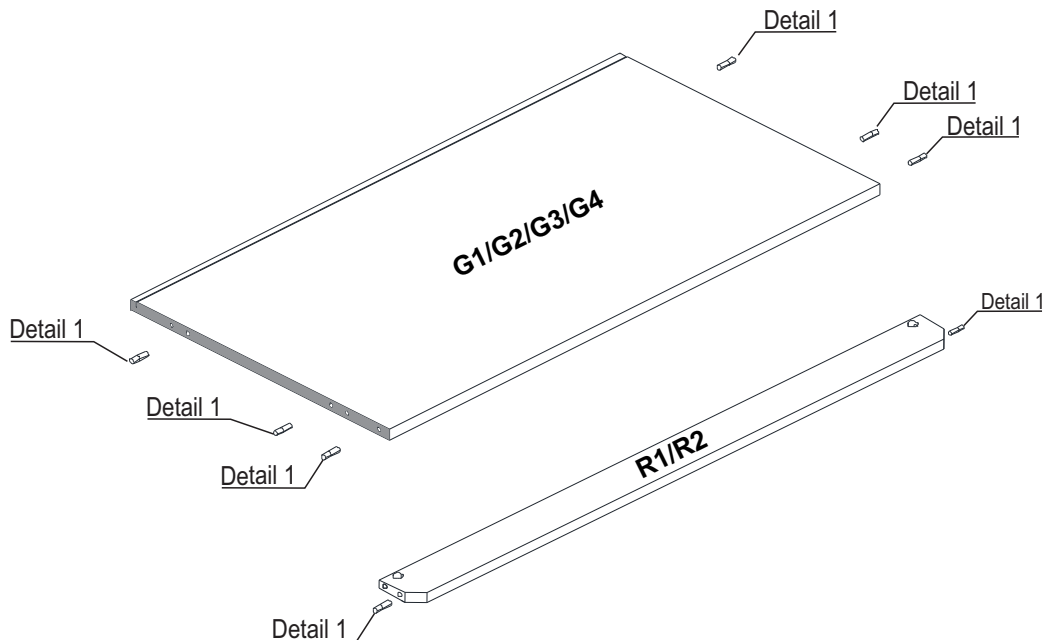
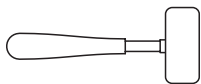

**Detalhe 1**

# PASSO 4

**PARTES REQUERIDAS**  
**PARTS REQUIRED**  
**PIEZAS NECESARIAS**

E1/E2/E3/E4-Tampo/top panel/  
 panel superior x1

**FERRAGENS NECESSÁRIAS**

**HARDWARE REQUIRED**

**MATERIALES NECESARIOS**

A  01

B  06  
 Ø 8,0 x 30mm

**FERRAMENTAS NECESSÁRIAS**

**TOOLS REQUIRED**

**HERRAMIENTAS NECESARIAS**

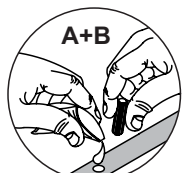
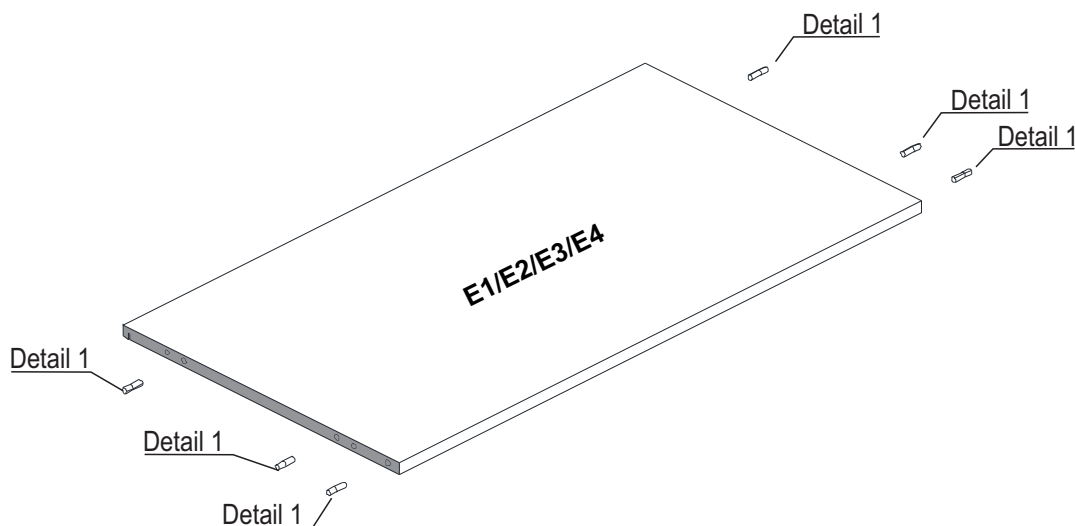
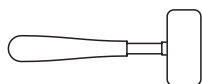

**Detalhe 1**



# PASSO 5

**PARTES REQUERIDAS**  
**PARTS REQUIRED**  
**PIEZAS NECESARIAS**

N1/N2/N3/N4-Rodapé frontal/front horizontal support/  
soporte horizontal delantero x2

O1/O2/O3/O4-Rodapé lateral/side  
support/soporte lateral x2

**FERRAGENS NECESSÁRIAS**  
**HARDWARE REQUIRED**  
**MATERIALES NECESARIOS**

A		01
B		08

Ø 8,0 x 30mm

**FERRAMENTAS NECESSÁRIAS**  
**TOOLS REQUIRED**  
**HERRAMIENTAS NECESARIAS**

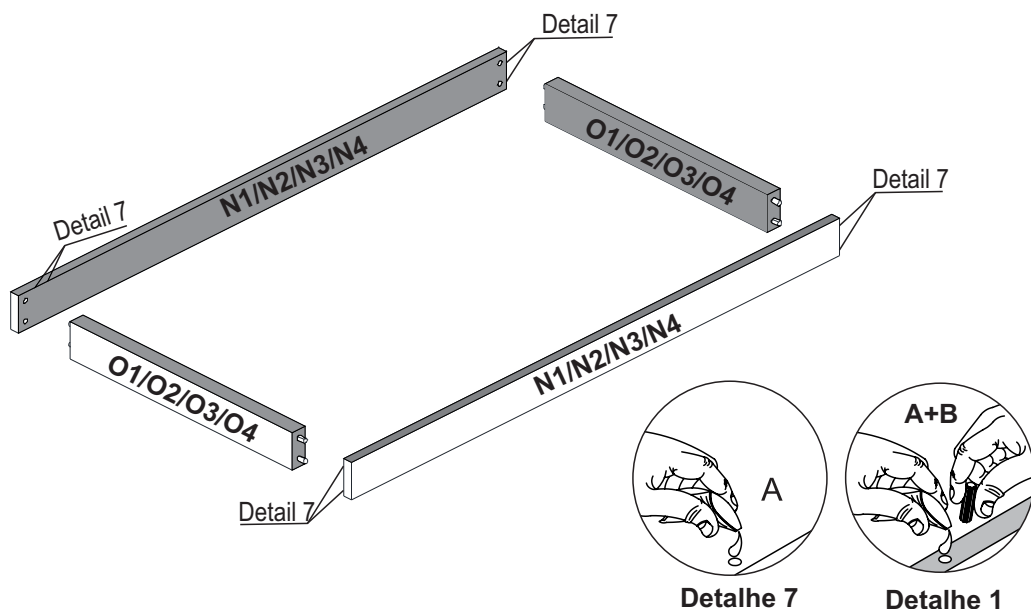
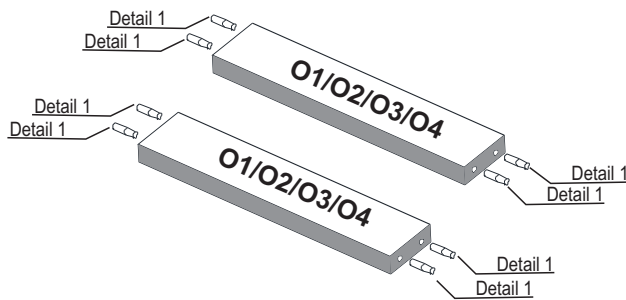
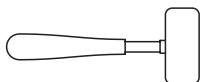



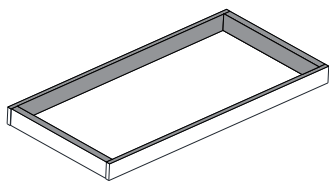

# PASSO 6

**PARTES REQUERIDAS**  
**PARTS REQUIRED**  
**PIEZAS NECESARIAS**



**FERRAGENS NECESSÁRIAS**  
**HARDWARE REQUIRED**  
**MATERIALES NECESARIOS**

C		16
I		04
L		12
D		06

**FERRAMENTAS NECESSÁRIAS**  
**TOOLS REQUIRED**  
**HERRAMIENTAS NECESARIAS**

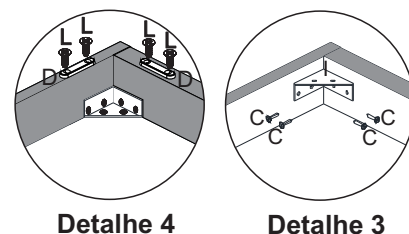
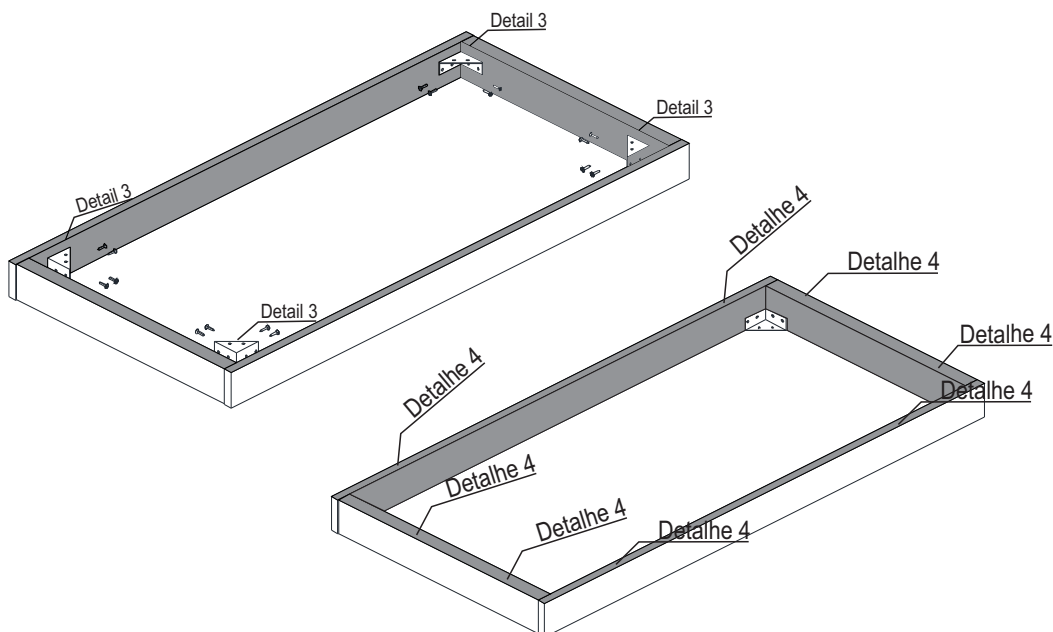
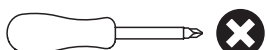

# PASSO 7

**PARTES REQUERIDAS**  
**PARTS REQUIRED**  
**PIEZAS NECESARIAS**

A1/A2/A3/A4-Montante curvo/ curved corner/esquina curva x1

L1/L2/L3/L4-Lateral direita/right side/lado derecho x1

**FERRAGENS NECESSÁRIAS**  
**HARDWARE REQUIRED**  
**MATERIALES NECESARIOS**

A  01

J  02

K  01

**FERRAMENTAS NECESSÁRIAS**  
**TOOLS REQUIRED**  
**HERRAMIENTAS NECESARIAS**

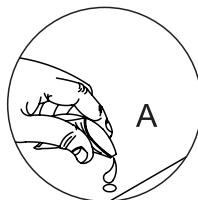
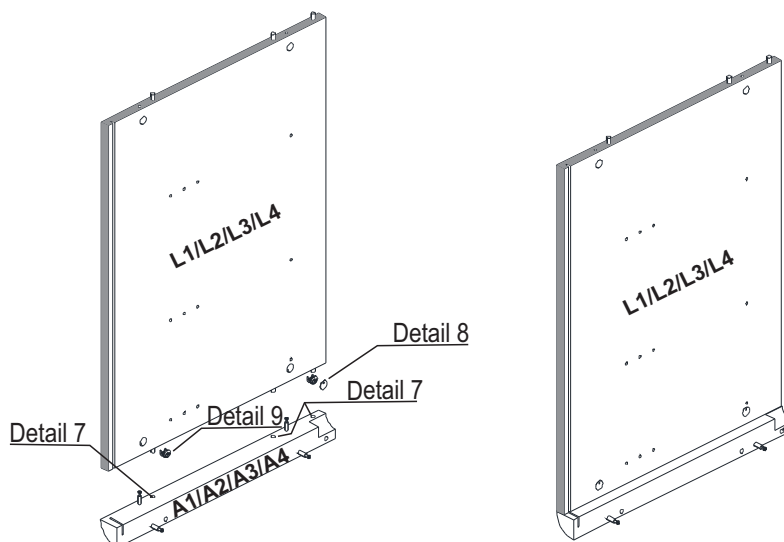
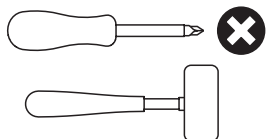

Detalhe 7

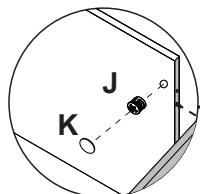

Detalhe 8

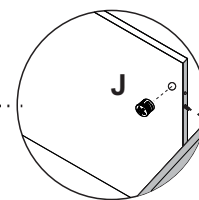
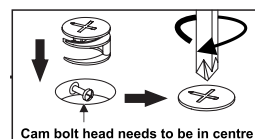

Detalhe 9

# PASSO 8

**PARTES REQUERIDAS**  
**PARTS REQUIRED**  
**PIEZAS NECESARIAS**

A1/A2/A3/A4-Montante curvo / curved corner/esquina curva x1

M1/M2/M3/M4- Lateral esquerda/left side/lado izquierdo x1

**FERRAGENS NECESSÁRIAS**  
**HARDWARE REQUIRED**  
**MATERIALES NECESARIOS**

A  01

J  02

**FERRAMENTAS NECESSÁRIAS**  
**TOOLS REQUIRED**  
**HERRAMIENTAS NECESARIAS**

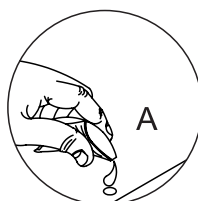
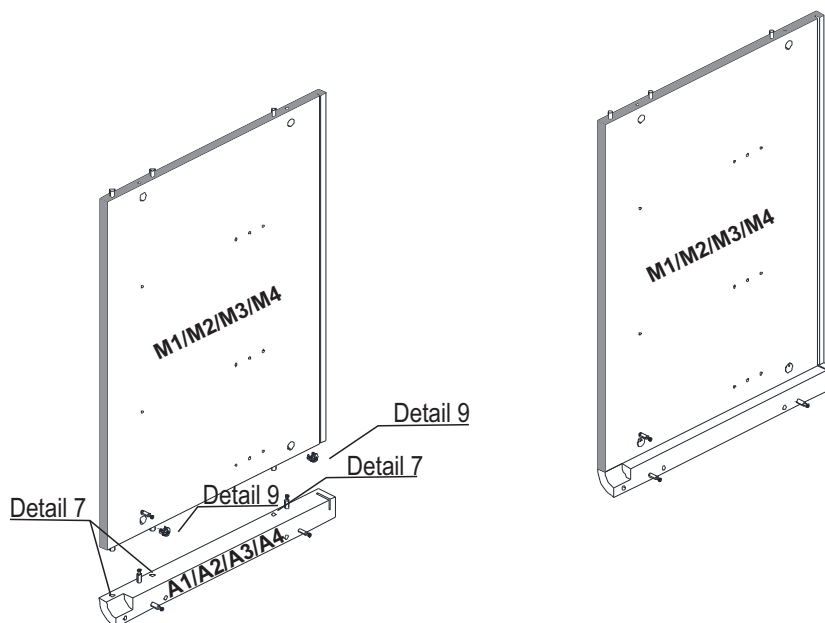
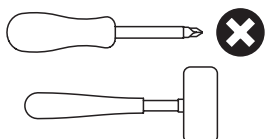

Detalhe 7

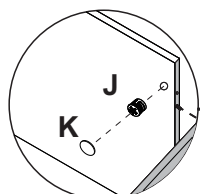

Detalhe 8

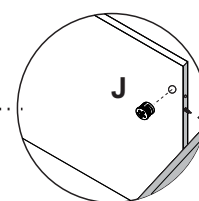
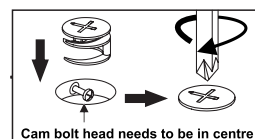

Detalhe 9

# PASSO 9



**PARTES REQUERIDAS**  
**PARTS REQUIRED**  
**PIEZAS NECESARIAS**

A1/A2/A3/A4-Montante curvo/ curved corner/esquina curva x1

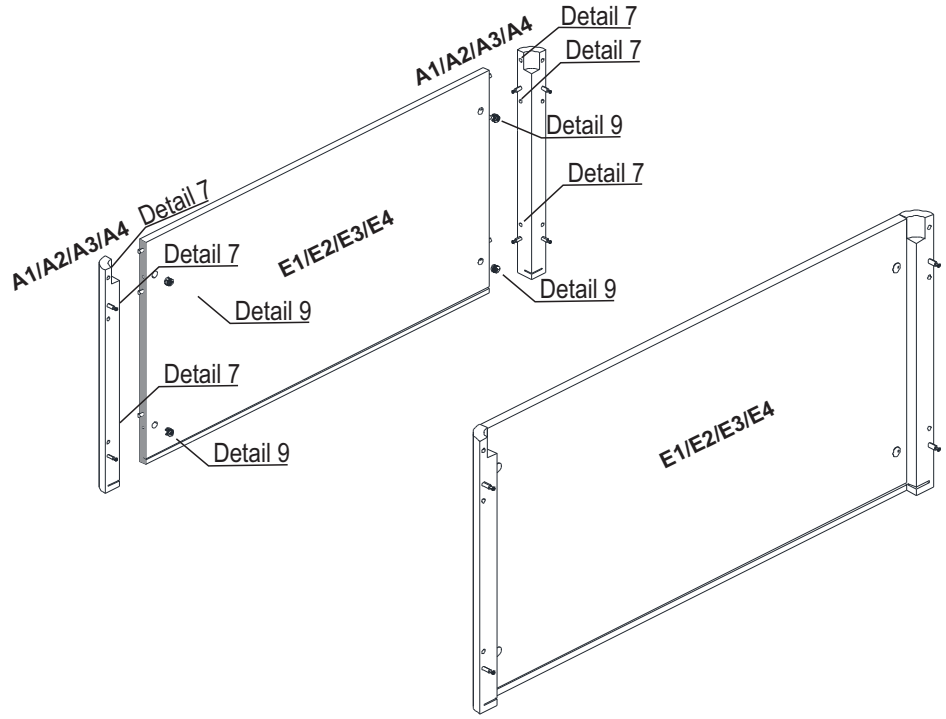
E1/E2/E3/E4-Tampo/top panel/ panel superior x1



**FERRAGENS NECESSÁRIAS**  
**HARDWARE REQUIRED**  
**MATERIALES NECESARIOS**

A	 Cola	01
J		04

**FERRAMENTAS NECESSÁRIAS**  
**TOOLS REQUIRED**  
**HERRAMIENTAS NECESARIAS**

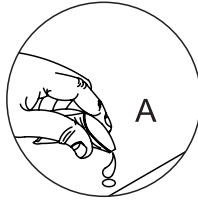
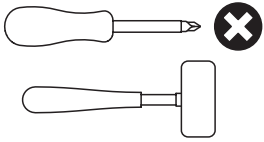

Detalhe 7

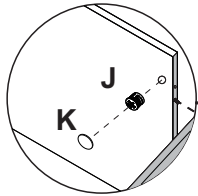

Detalhe 8

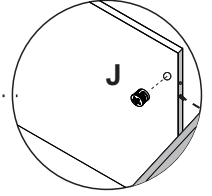
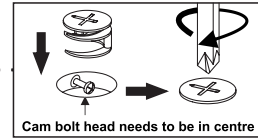

Detalhe 9

# PASSO 10



**PARTES REQUERIDAS**  
**PARTS REQUIRED**  
**PIEZAS NECESARIAS**

M1/M2/M3/M4- Lateral esquerda/left side/ lado izquierdo x1

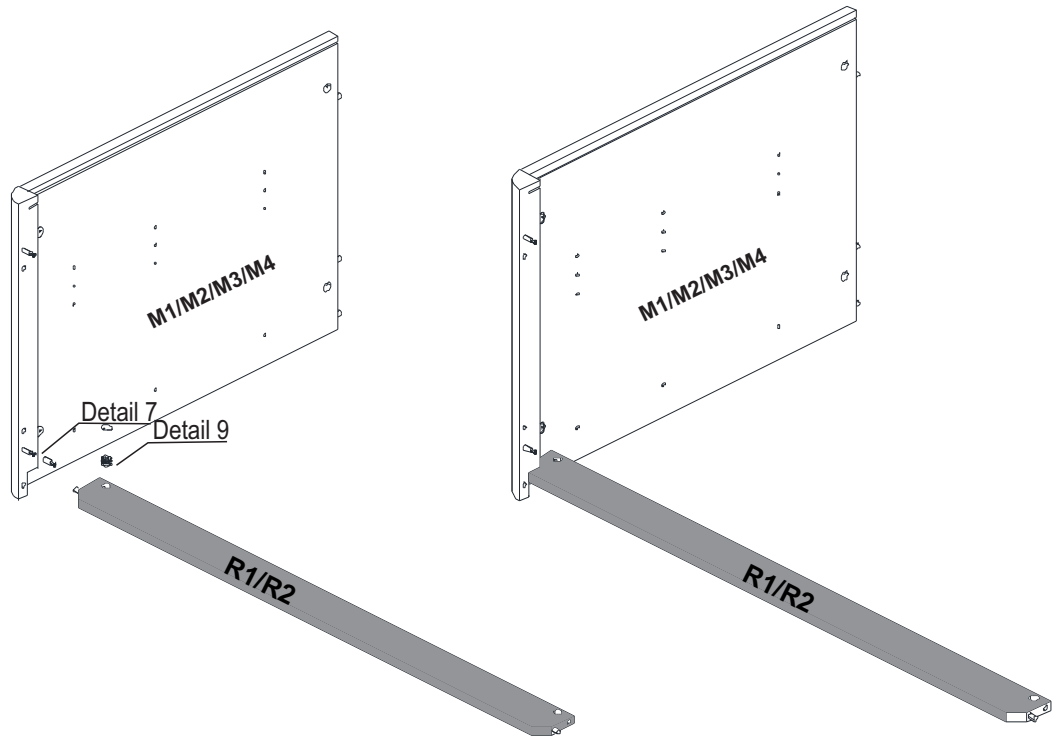
R1/R2-Travessa Inferior/ lower crossbar/ lower crossbar/travesaño inferior x1



**FERRAGENS NECESSÁRIAS**  
**HARDWARE REQUIRED**  
**MATERIALES NECESARIOS**

A	 Cola	01
J		01

**FERRAMENTAS NECESSÁRIAS**  
**TOOLS REQUIRED**  
**HERRAMIENTAS NECESARIAS**

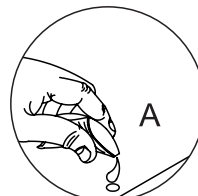
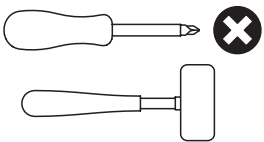

Detalhe 7

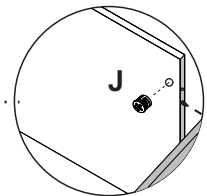
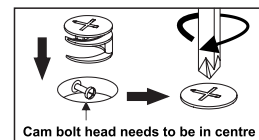

Detalhe 9



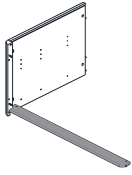

# PASSO 11

PARTES REQUERIDAS  
PARTS REQUIRED  
PIEZAS NECESARIAS



G1/G2/G3/G4-Base inferior/bottom base/  
base inferior x1

FERRAGENS NECESSÁRIAS  
HARDWARE REQUIRED  
MATERIALES NECESARIOS

A		01
J		02

FERRAMENTAS NECESSÁRIAS  
TOOLS REQUIRED  
HERRAMIENTAS NECESARIAS

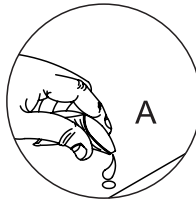
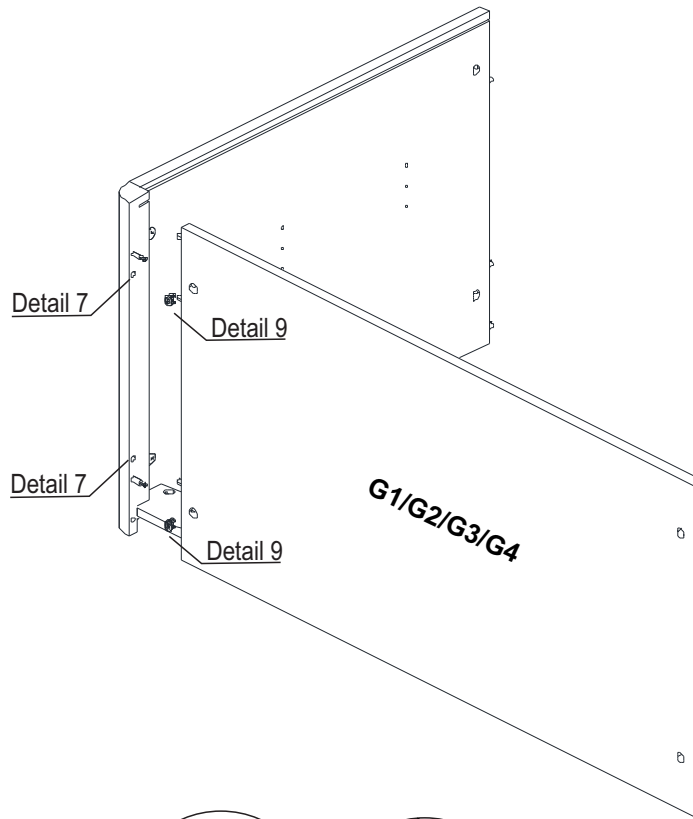
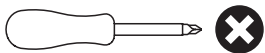

Detalhe 7

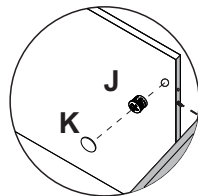

Detalhe 8

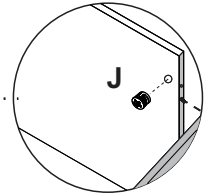
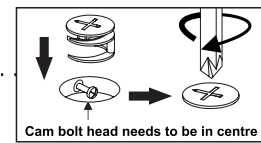

Detalhe 9

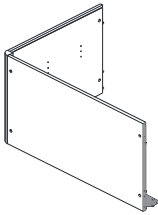

# PASSO 12

PARTES REQUERIDAS  
PARTS REQUIRED  
PIEZAS NECESARIAS



M1/M2/M3/M4- Lateral esquerda/  
left side/lado izquierdo x1

FERRAGENS NECESSÁRIAS  
HARDWARE REQUIRED  
MATERIALES NECESARIOS

A		01
J		03

FERRAMENTAS NECESSÁRIAS  
TOOLS REQUIRED  
HERRAMIENTAS NECESARIAS

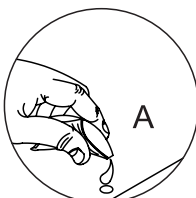
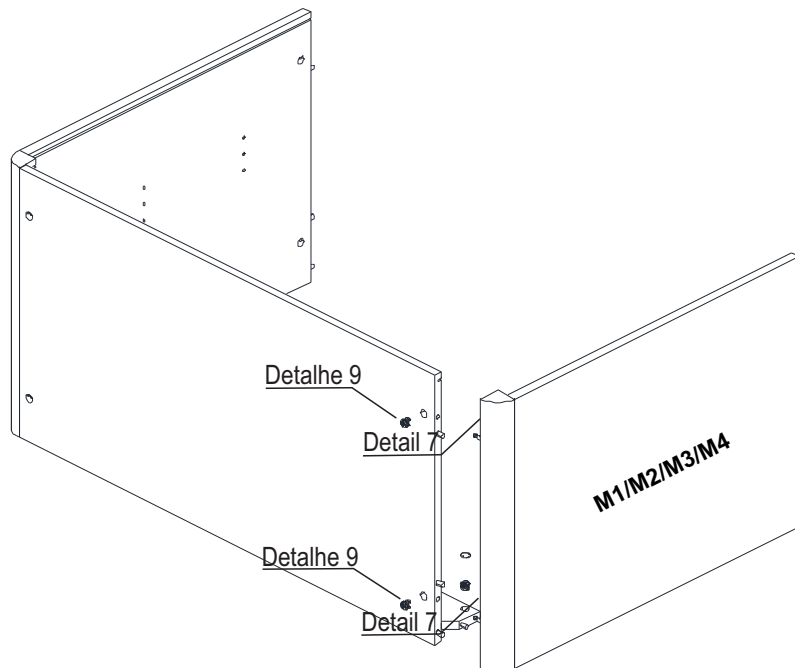
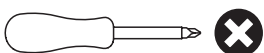

Detalhe 7

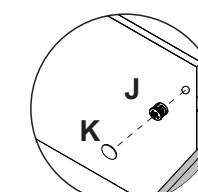

Detalhe 8

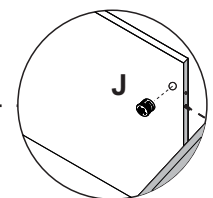
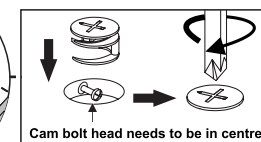

Detalhe 9

# PASSO 13

PARTES REQUERIDAS  
PARTS REQUIRED  
PIEZAS NECESARIAS

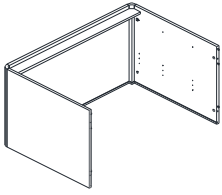

P1-Perfil I 714mm/profile I  
 perfil I x1

H1-Costa da comoda/product fund/  
 fondo de producto x2

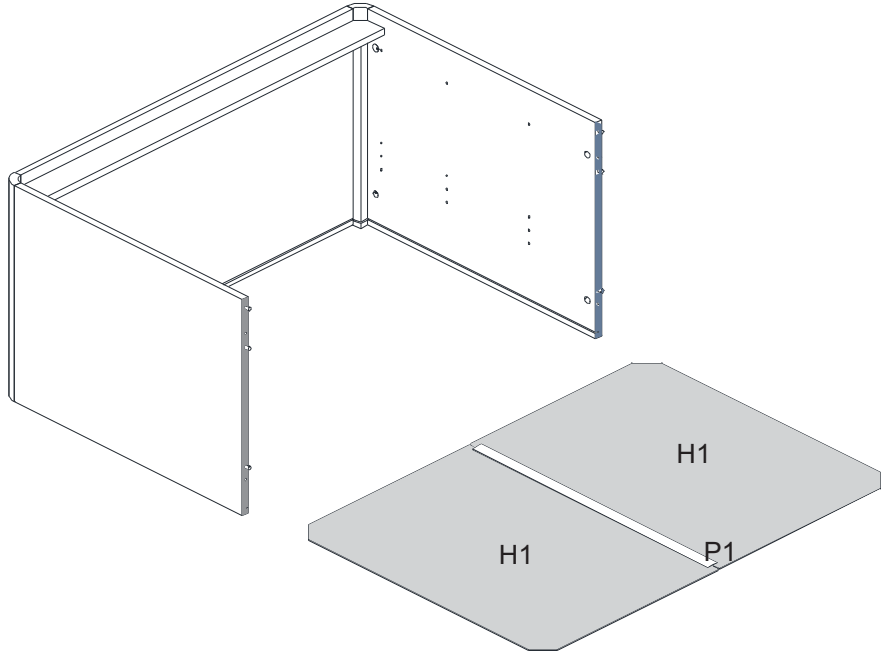

FERRAGENS NECESSÁRIAS  
HARDWARE REQUIRED  
MATERIALES NECESARIOS

FERRAMENTAS NECESSÁRIAS  
TOOLS REQUIRED  
HERRAMIENTAS NECESARIAS

# PASSO 14

PARTES REQUERIDAS  
PARTS REQUIRED  
PIEZAS NECESARIAS

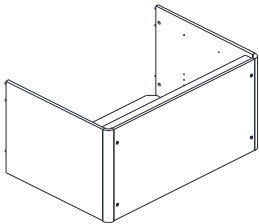

E1/E2/E3/E4-Tampo/top panel/  
 panel superior x1

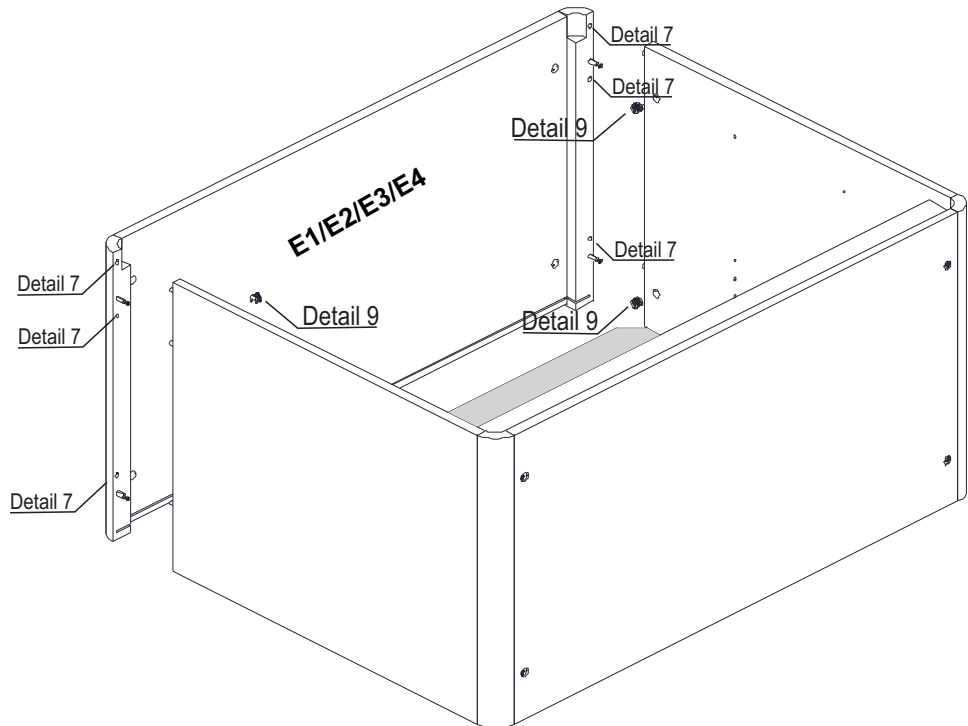

FERRAGENS NECESSÁRIAS  
HARDWARE REQUIRED  
MATERIALES NECESARIOS

A  01

J  04

FERRAMENTAS NECESSÁRIAS  
TOOLS REQUIRED  
HERRAMIENTAS NECESARIAS

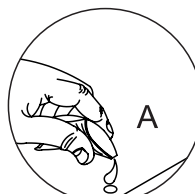
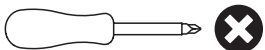

Detalhe 7

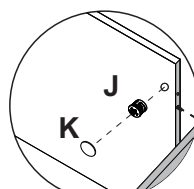

Detalhe 8

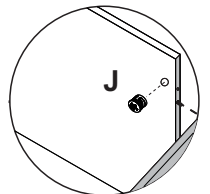
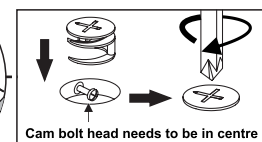

Detalhe 9

# PASSO 15

**PARTES REQUERIDAS**  
**PARTS REQUIRED**  
**PIEZAS NECESARIAS**

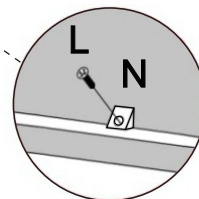
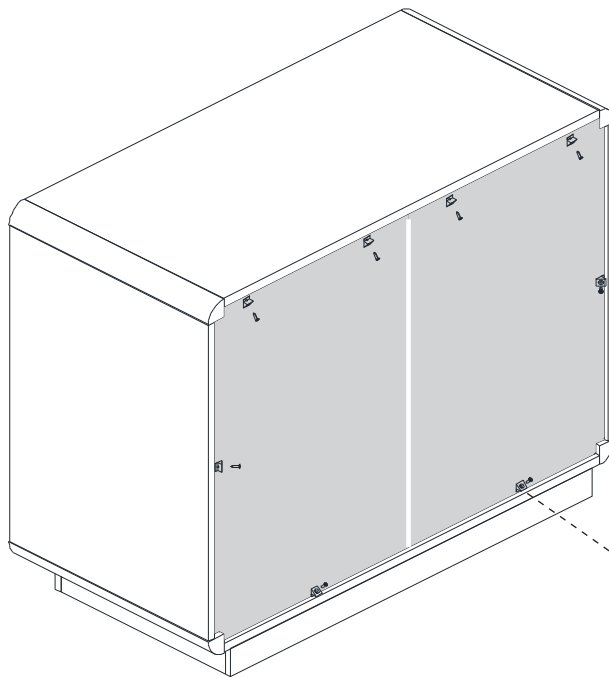
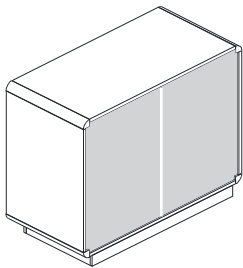

**FERRAGENS NECESSÁRIAS**

**HARDWARE REQUIRED**

**MATERIALES NECESARIOS**

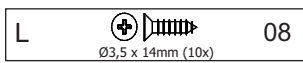

**FERRAMENTAS NECESSÁRIAS**

**TOOLS REQUIRED**

**HERRAMIENTAS NECESARIAS**

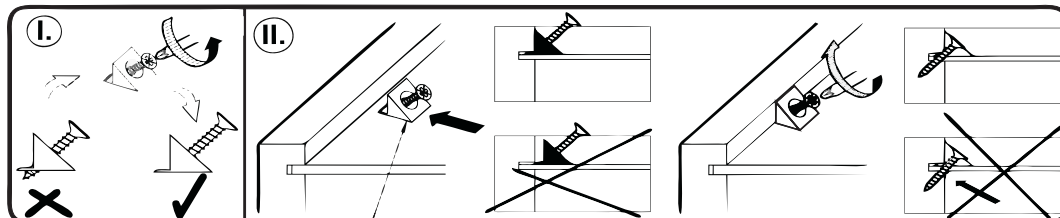
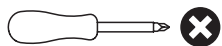

# PASSO 16

**PARTES REQUERIDAS**  
**PARTS REQUIRED**  
**PIEZAS NECESARIAS**

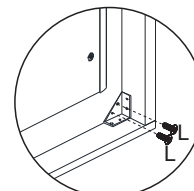
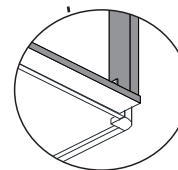
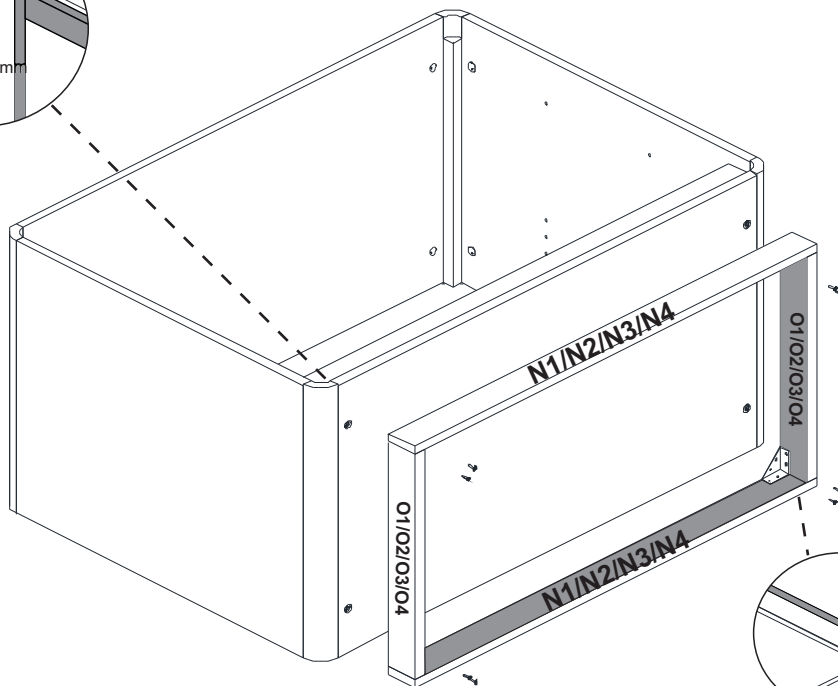
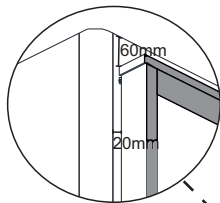
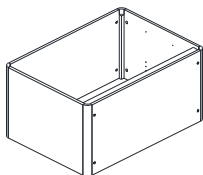

N1/N2/N3/N4-Rodapé frontal/front horizontal support/  
 soporte horizontal delantero x2

O1/O2/O3/O4-Rodapé lateral/side  
 support/soporte lateral x2

**FERRAGENS NECESSÁRIAS**

**HARDWARE REQUIRED**

**MATERIALES NECESARIOS**

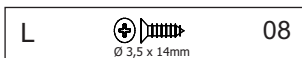

**FERRAMENTAS NECESSÁRIAS**

**TOOLS REQUIRED**

**HERRAMIENTAS NECESARIAS**

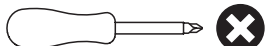

# PASSO 17

**PARTES REQUERIDAS**  
**PARTS REQUIRED**  
**PIEZAS NECESARIAS**

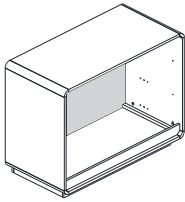

Q1-Trilho telescópico 350mm/  
 telescopic rail/carril telescópico x3

**FERRAGENS NECESSÁRIAS**  
**HARDWARE REQUIRED**  
**MATERIALES NECESARIOS**

F  18  
 Ø 6,0 x 12mm

**FERRAMENTAS NECESSÁRIAS**  
**TOOLS REQUIRED**  
**HERRAMIENTAS NECESARIAS**

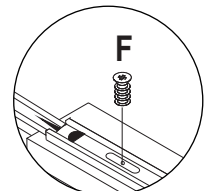
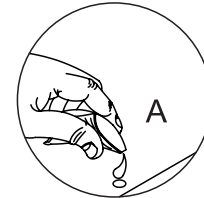
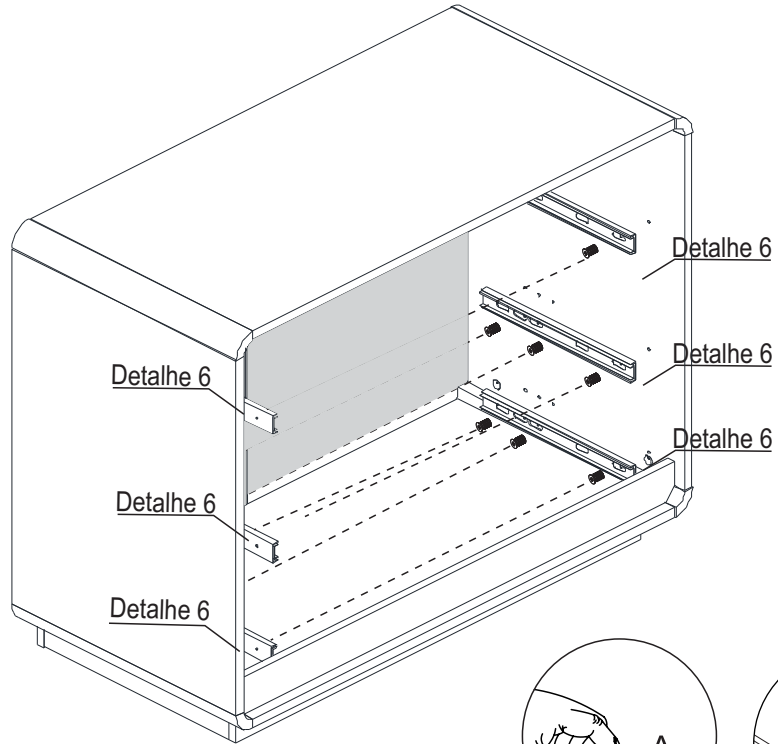
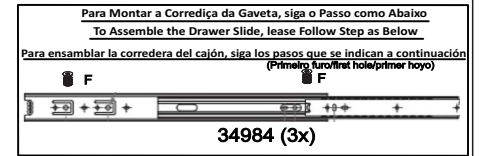
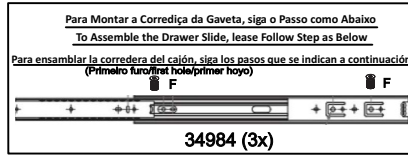
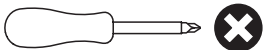

Detalhe 7

Detalhe 6

# PASSO 18

**PARTES REQUERIDAS**  
**PARTS REQUIRED**  
**PIEZAS NECESARIAS**

K1/K2/K3/K4-Frontal de gav. sup./top drawer front/  
 frente del cajón superior x1

J1/J2/J3/J4-Frontal de gav. central/central  
 drawer front/frente del cajón central x1

I1/I2/I3/I4-Frontal de gav. inf./bottom  
 drawer front/frente del cajón inferior x1

**FERRAGENS NECESSÁRIAS**  
**HARDWARE REQUIRED**  
**MATERIALES NECESARIOS**

E  06

**FERRAMENTAS NECESSÁRIAS**  
**TOOLS REQUIRED**  
**HERRAMIENTAS NECESARIAS**

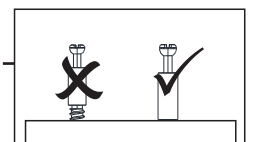
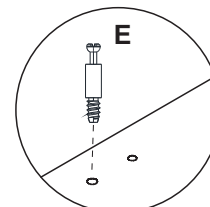
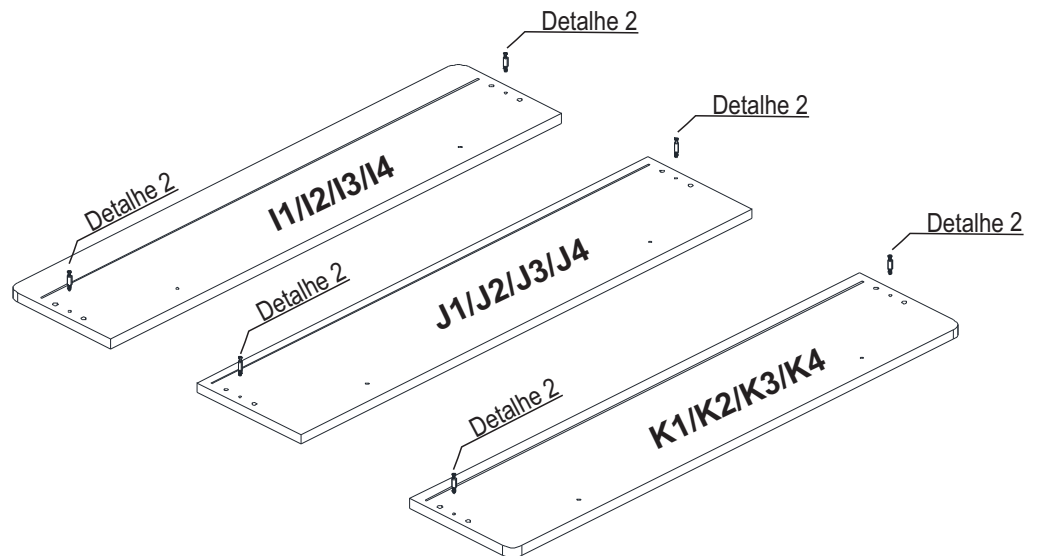

# PASSO 19

**PARTES REQUERIDAS**  
**PARTS REQUIRED**  
**PIEZAS NECESARIAS**

C1/C2-Lateral gav. dir./right drawer side/  
lado derecho del cajón x3

D1/D2-Lateral gav. esq./left drawer side/  
lado izquierdo del cajón x3

**FERRAGENS NECESSÁRIAS**  
**HARDWARE REQUIRED**  
**MATERIALES NECESARIOS**

A  01

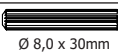
B  12  
Ø 8,0 x 30mm

L  18  
Ø 3,5 x 12mm

**FERRAMENTAS NECESSÁRIAS**  
**TOOLS REQUIRED**  
**HERRAMIENTAS NECESARIAS**

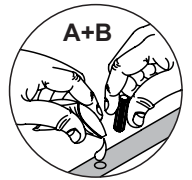
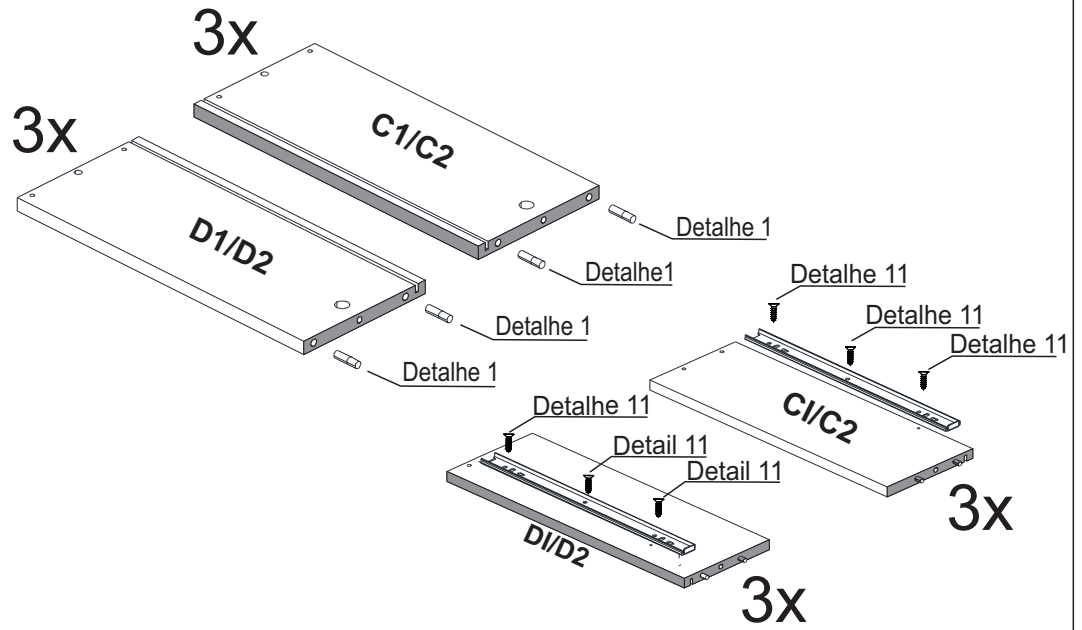
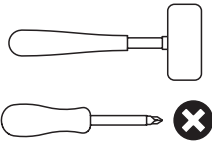

Detalhe 1

# PASSO 20

**PARTES REQUERIDAS**  
**PARTS REQUIRED**  
**PIEZAS NECESARIAS**

C1/C2-Lateral gav. dir./right drawer side/  
lado derecho del cajón x3

D1/D2-Lateral gav. esq./left drawer side/  
lado izquierdo del cajón x3

F1/F2-Traseiro de gaveta/drawer back/  
parte trasera del cajón x3

**FERRAGENS NECESSÁRIAS**  
**HARDWARE REQUIRED**  
**MATERIALES NECESARIOS**

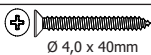
G  12  
Ø 4,0 x 40mm

**FERRAMENTAS NECESSÁRIAS**  
**TOOLS REQUIRED**  
**HERRAMIENTAS NECESARIAS**

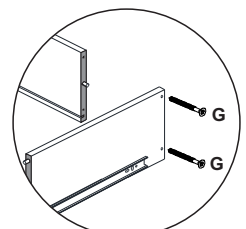
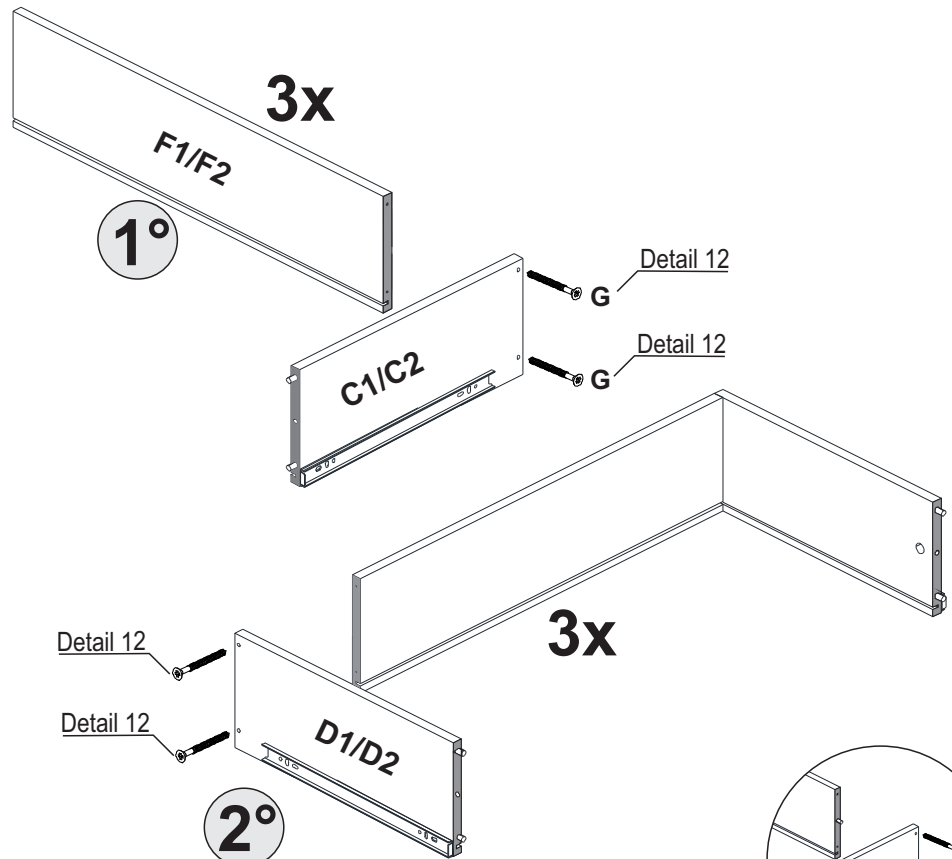

Detalhe 12

# PASSO 21

PARTES REQUERIDAS  
PARTS REQUIRED  
PIEZAS NECESARIAS

B1-Fundo de gaveta/drawer bottom/  
fondo del cajón x3

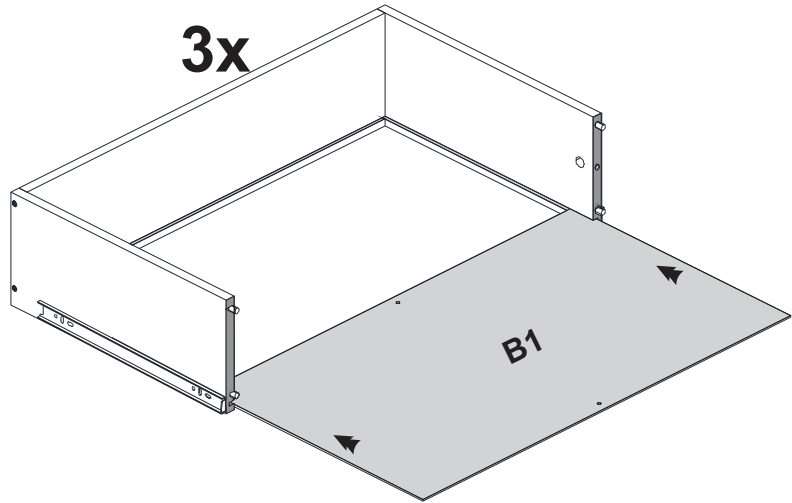
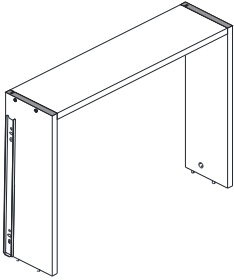

FERRAGENS NECESSÁRIAS  
HARDWARE REQUIRED  
MATERIALES NECESARIOS

FERRAMENTAS NECESSÁRIAS  
TOOLS REQUIRED  
HERRAMIENTAS NECESARIAS

# PASSO 22

PARTES REQUERIDAS  
PARTS REQUIRED  
PIEZAS NECESARIAS

K1/K2/K3/K4-Frontal de gav. sup./top drawer front/  
frente del cajón superior x1

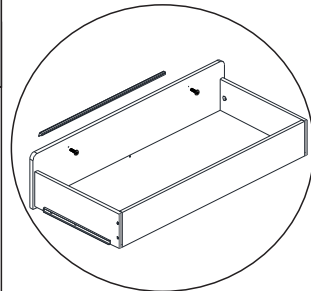
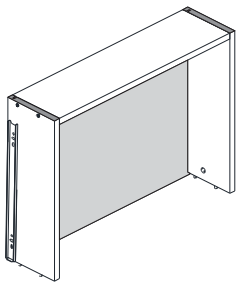

Os puxadores devem ser adquiridos  
separadamente !

FERRAGENS NECESSÁRIAS  
HARDWARE REQUIRED  
MATERIALES NECESARIOS

A  01

J  02

K  02

FERRAMENTAS NECESSÁRIAS  
TOOLS REQUIRED  
HERRAMIENTAS NECESARIAS

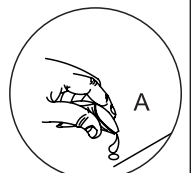
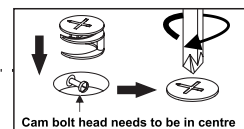
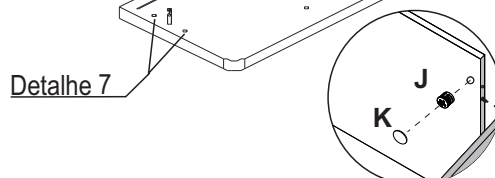
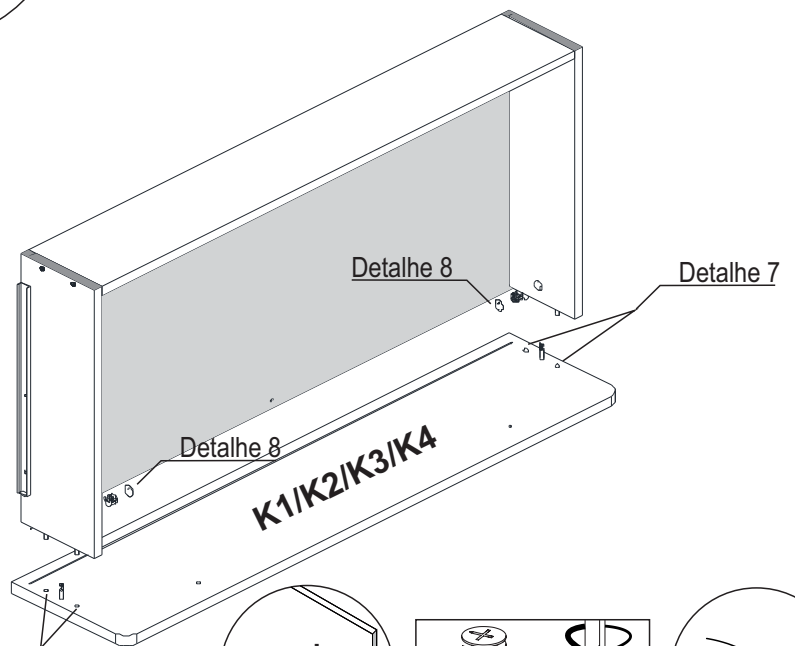

Detalhe 8

Detalhe 7





# PASSO 23

**PARTES REQUERIDAS**  
**PARTS REQUIRED**  
**PIEZAS NECESARIAS**

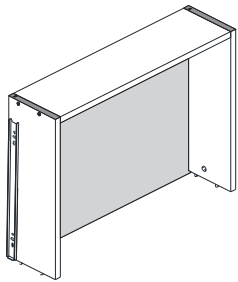
J1/J2/J3/J4-Frontal de gav. central/central drawer front/frente del cajón central x1



**FERRAGENS NECESSÁRIAS**  
**HARDWARE REQUIRED**  
**MATERIALES NECESARIOS**

A	 Cola	01
J		02
K		02

**FERRAMENTAS NECESSÁRIAS**  
**TOOLS REQUIRED**  
**HERRAMIENTAS NECESARIAS**

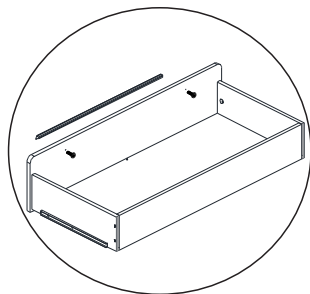

Os puxadores devem ser adquiridos separadamente !

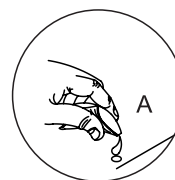
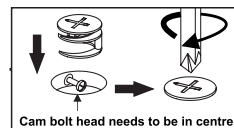
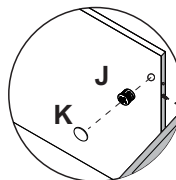
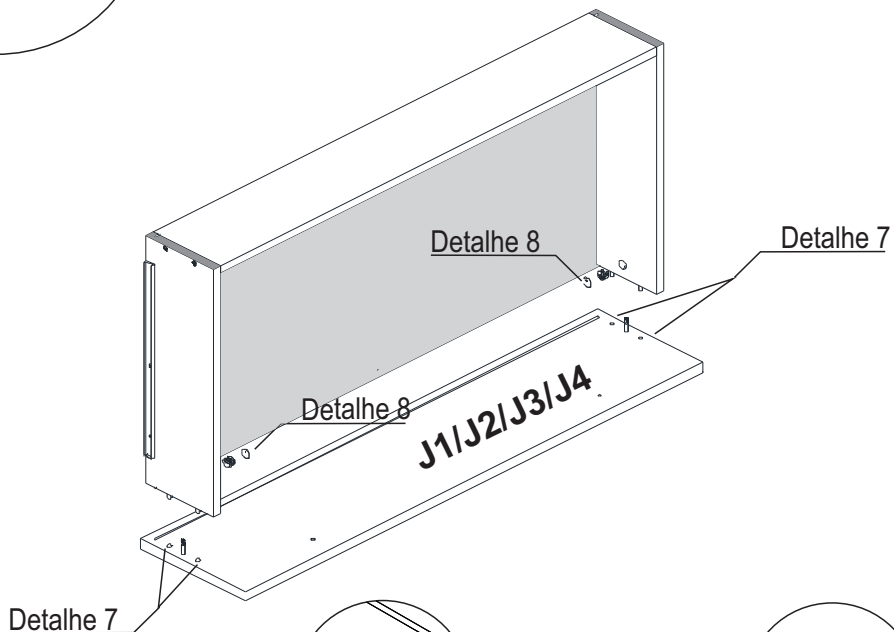

Detalhe 8

Detalhe 7



# PASSO 24

**PARTES REQUERIDAS**  
**PARTS REQUIRED**  
**PIEZAS NECESARIAS**

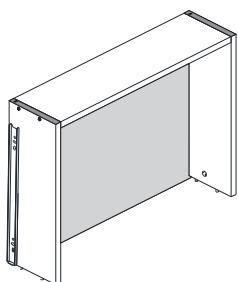
I1/I2/I3/I4-Frontal de gav. inf./bottom drawer front/frente del cajón inferior x1



**FERRAGENS NECESSÁRIAS**  
**HARDWARE REQUIRED**  
**MATERIALES NECESARIOS**

A	 Cola	01
J		02
K		02

**FERRAMENTAS NECESSÁRIAS**  
**TOOLS REQUIRED**  
**HERRAMIENTAS NECESARIAS**

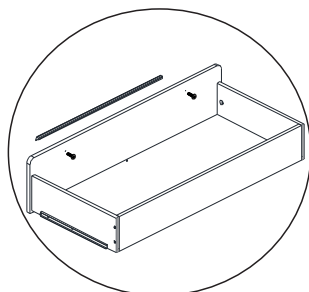

Os puxadores devem ser adquiridos separadamente !

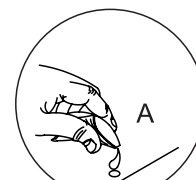
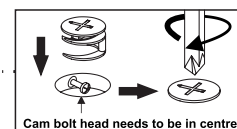
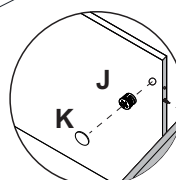
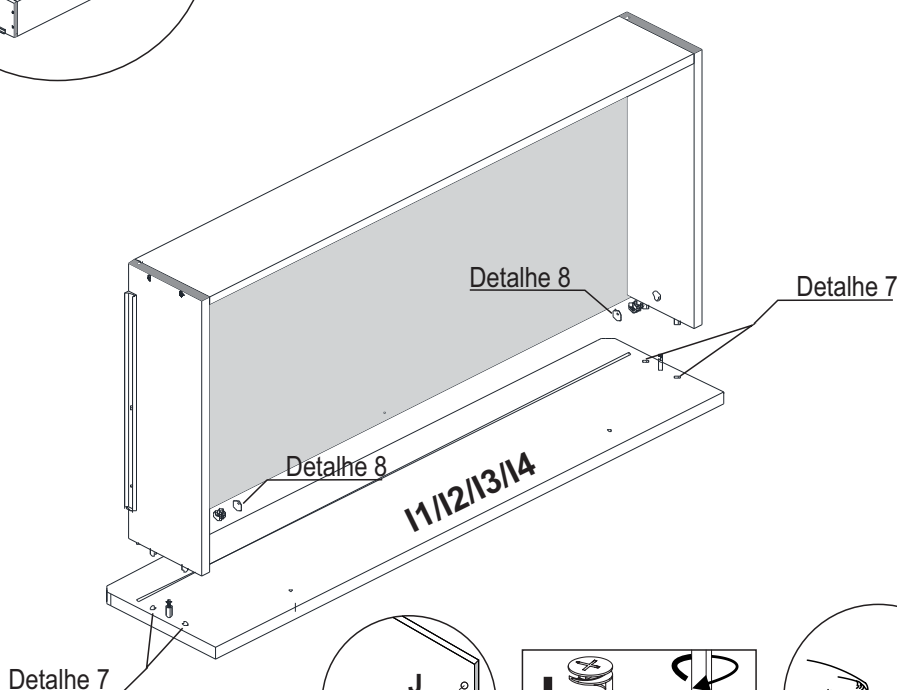

Detalhe 8

Detalhe 7

# PASSO 25

PARTES REQUERIDAS  
PARTS REQUIRED  
PIEZAS NECESARIAS

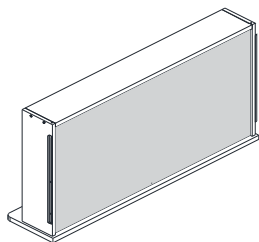

FERRAGENS NECESSÁRIAS  
HARDWARE REQUIRED  
MATERIALES NECESARIOS

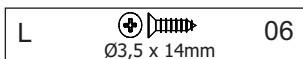

FERRAMENTAS NECESSÁRIAS  
TOOLS REQUIRED  
HERRAMIENTAS NECESARIAS

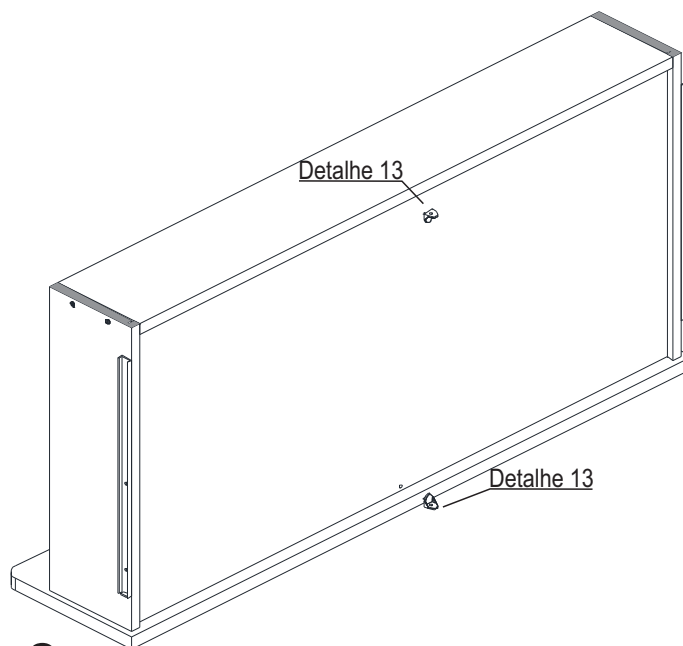
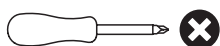

**3x**

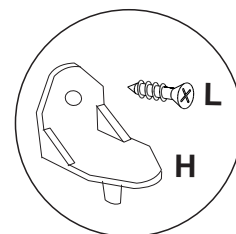

Detalhe 13

# PASSO 26

PARTES REQUERIDAS  
PARTS REQUIRED  
PIEZAS NECESARIAS

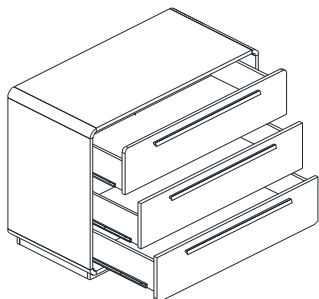

FERRAGENS NECESSÁRIAS  
HARDWARE REQUIRED  
MATERIALES NECESARIOS

FERRAMENTAS NECESSÁRIAS  
TOOLS REQUIRED  
HERRAMIENTAS NECESARIAS

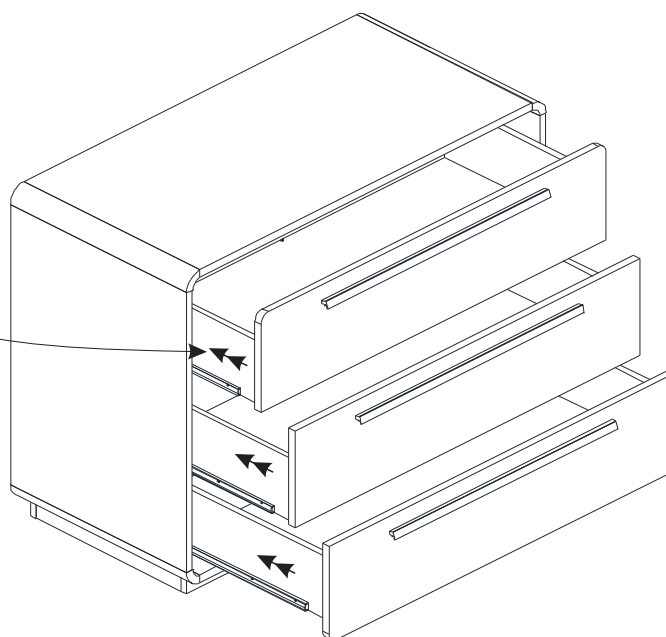
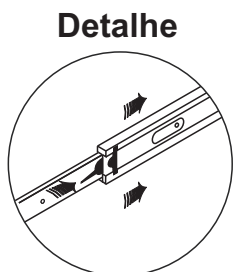

# PASSO 27

PARTES REQUERIDAS  
PARTS REQUIRED  
PIEZAS NECESARIAS



FERRAGENS NECESSÁRIAS  
HARDWARE REQUIRED  
MATERIALES NECESARIOS

**M**  **01**

FERRAMENTAS NECESSÁRIAS  
TOOLS REQUIRED  
HERRAMIENTAS NECESARIAS

