

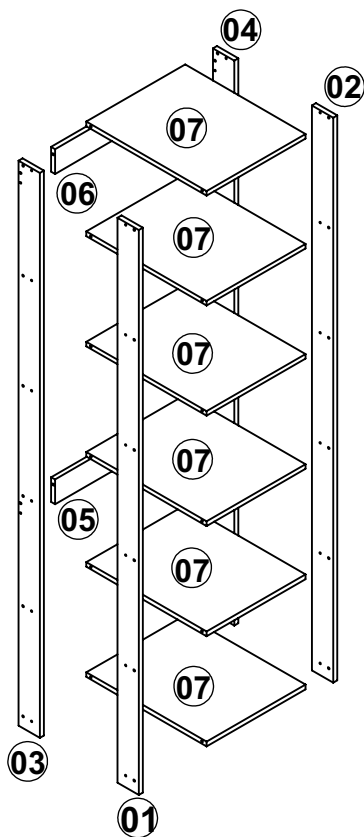

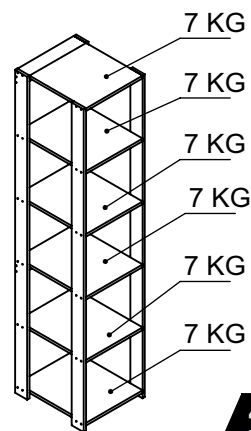



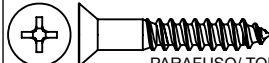

CL040DATA/FECHA/DATA:01/09/2022
REVISÃO/REVISIÓN/REVISION:01**INSTRUÇÕES DE MONTAGEM**
INSTRUCCIONES DE MONTAJE
ASSEMBLY'S INSTRUCTIONS @prodecormoveisRua: José Sachet / 213 A / Bairro São Francisco
Farroupilha / RS / 95171-018 / Fone:(54) 3261-1165**CLOSET 6 PRATELEIRA**
CLOSET 6 ESTANTES
CLOSET 6 SHELVES**LISTA DE PEÇAS / LISTA DE PIEZAS / FURNITURE PIECES LIST**

COD	DESCRIÇÃO/DESCRIPCIÓN/DESCRIPTION	DIMENSÃO/DIM/DIM	QTD
01	LATERAL ESQUERDA FRONTAL/ LATERAL IZQUIERDO FRONTAL/ FRONT LEFT SIDE	1830X80X15	01
02	LATERAL DIREITA FRONTAL/ LATERAL DERECHO FRONTAL/ FRONT RIGHT SIDE	1830X80X15	01
03	LATERAL ESQUERDA TRASEIRA/ LATERAL IZQUIERDO TRASERA/ BACK LEFT SIDE	1830X80X15	01
04	LATERAL DIREITA TRASEIRA/ LATERAL DERECHO TRASERA/ BACK RIGHT SIDE	1830X80X15	01
05	TRAVESSA INFERIOR/ TRAVESAÑO INFERIOR/ LOWER CROSSPIECE	370X80X15	01
06	TRAVESSA SUPERIOR/ TRAVESAÑO SUPERIOR/ UPPER CROSSPIECE	370X80X15	01
07	PRATELEIRA/ ESTANTE/ SHELF	370X450X15	06

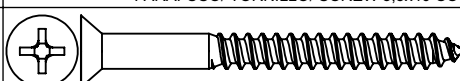
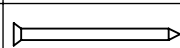
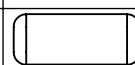
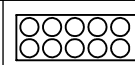
**PESO MÁXIMO SUPORTADO PELO PRODUTO 42 KG**
PESO MÁXIMO SOPORTADO POR EL PRODUCTO 42 KG
MAXIMUM WEIGHT TOLERATED BY THE PRODUCT 42 KG

REF	DESCRIÇÃO	QTD
A	 CAVILHA/ CLAVIJA/ WOOD DOWEL 6x30MM	28
B	 PARAFUSO/ TORNILLO/ SCREW 4x25 CC	03
C	 PARAFUSO/ TORNILLO/ SCREW 3,5x40 CC	28
D	 PARAFUSO/ TORNILLO/ SCREW 4x40 CC	02
E	 PREGO/ CLAVO/ NAIL 10X10	04
F	 COLA/ PEGAMENTO/ GLUE	01
G	 ADESIVO TAPAFURO / ADHESIVO/ STICKER 15MM	29
H	 SAPATA/ ZAPATO/ SHOE	04
I	 BUCHA PLÁSTICA / CASQUILLO / BUSHING 8MM	02
J	 ADESIVO PRO. DECOR/ ADESIVO PRO. DECOR/ ADHESIVE PRO. DECOR	01

FERRAMENTAS NECESSÁRIAS:
HERRAMIENTAS NECESARIAS:
NECESSARY TOOLS:**IMPORTANTE LER COM ATENÇÃO E GUARDAR PARA EVENTUAIS CONSULTAS.**
IMPORTANTE LEER CON ATENCIÓN Y GUARDAR PARA EVENTUALES CONSULTAS.
IMPORTANT TO READ CAREFULLY AND SAVE FOR ANY QUERIES.

Instruções de Montagem

Instrucciones de Montaje
Assembly's Instructions



RECOMENDAÇÕES:

01 - Examine completamente todas as peças do móvel antes de iniciar o trabalho.

02 - Recomenda-se montar o móvel conforme este Manual de Montagem.

03 - É de responsabilidade do montador seguir as instruções do Manual de Montagem, que são fundamentais para garantir a estrutura do móvel.

04 - Certifique-se de que todos os acessórios utilizados na montagem (parafusos, porcas, ponteiros) estejam fixados o suficiente, totalmente atarraxados, evitando que venham a provocar ferimentos.

LIMPEZA:

01 - Pano levemente umedecido com água, seguido de pano seco.

02 - Não utilizar produtos químicos ou abrasivos.

GARANTIA:

01 - 3 meses para defeitos ou vícios de origem.

ADVERTÊNCIAS:

01 - Esteja ciente do risco de chama aberta e outras fontes de calor, tais como aquecedores elétricos, aquecedores a gás etc. nas proximidades do produto.

02 - Não utilize o produto se alguma parte estiver quebrada, rasgada ou faltando. Utilizar somente peças de reposição aprovadas pelo fabricante.

RECOMENDACIONES:

01 - Examine completamente todas las piezas del mueble antes de empezar el montaje.

02 - Recomienda-se montar el mueble de acuerdo con este Manual de Montaje.

03 - Es de responsabilidad del montador seguir las instrucciones del Manual de Montaje, que son fundamentales para asegurar la estructura del mueble.

04 - Asegure-se de que todos los accesorios utilizados en el montaje (tornillos, tuercas, ponteras) estén fijados el suficiente, totalmente roscados, evitando que vengan a provocar lesiones.

LIMPIEZA:

01 - Paño levemente humedecido con agua, siguiendo de paño seco.

02 - No utilizar productos químicos o abrasivos.

GARANTÍA:

01 - 3 meses para defectos o vicios de origen.

ADVERTENCIAS:

01 - Tenga en cuenta el riesgo de llama abierta y otras fuentes de calor, tales como calentadores eléctricos, calentadores de gas, etc. en las proximidades del producto.

02 - No utilice el producto si alguna parte esté rota, o perdida. Utilizar sólo piezas de repuesto aprobadas por el fabricante.

RECOMMENDATIONS:

01 - Check completely all the furniture's pieces before start to assemble it.

02 - It is recommended to assemble this furniture according to this Assembly's Manual.

03 - It is the assembler's responsibility to follow the instructions of this Assembly's Manual, which are essential to ensure the furniture's structure.

04 - Ensure that all the accessories used in the assembly (bolts, nuts, tips) are well and enoughly fixed, completely threaded, avoiding injuries from happening.

CLEANSING:

01 - Cloth slightly moistened with water.

02 - Do not use chemicals or abrasives products.

WARRANTY:

01 - 3 months due to manufacture defects.

WARNINGS:

01 - Be aware of the risk of open flame and other sources of heat, such as electric heaters, gas heaters etc. around the product.

02 - Do not use the product if any part is broken, torn or missing. Only use replacement parts approved by the manufacturer.

CL040

INSTRUÇÃO DE MONTAGEM
INSTRUCCIONES DE MONTAJE
ASSEMBLY'S INSTRUCTIONS



COLOCAR COLA "F" NAS CAVILHAS "A".
COLOCAR PEGAMENTO "F" EN LAS CLAVIJAS "A".
PLACE GLUE "F" ON DOWELS "A".

