

# RP3634 - ROUPEIRO

Manual de Montagem  
 Assembly Instructions  
 Instrucción de Montaje

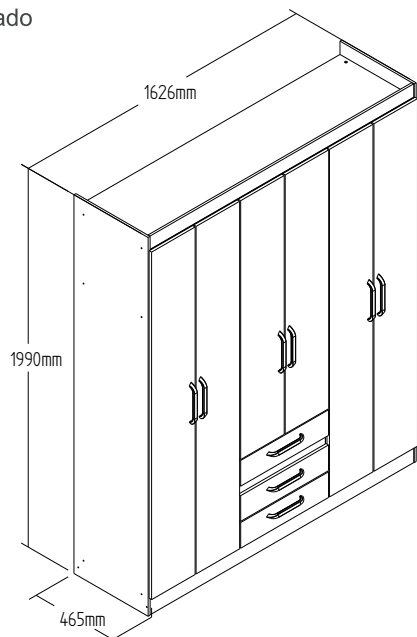

Produto Montado  
 Producto final  
 Assembled



1º

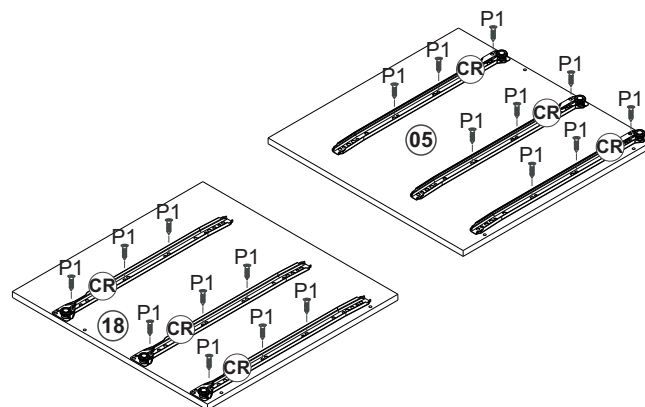
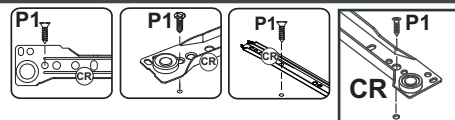

2º

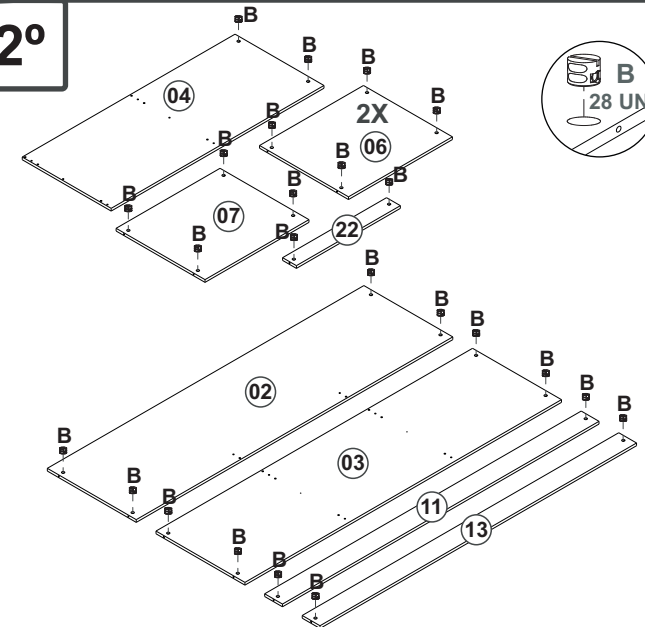

03º

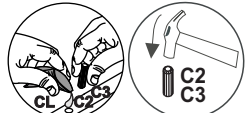
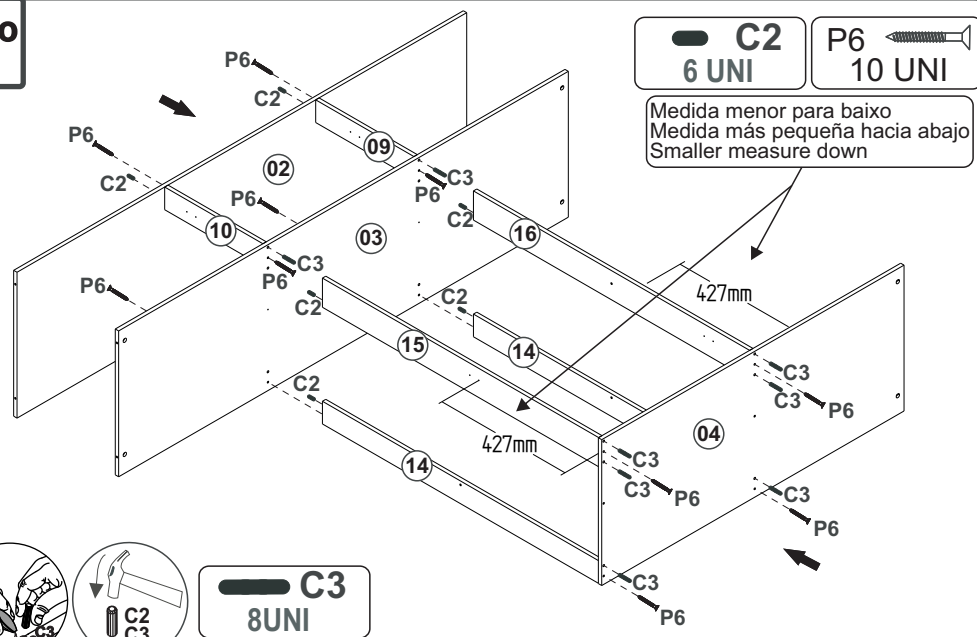

04º

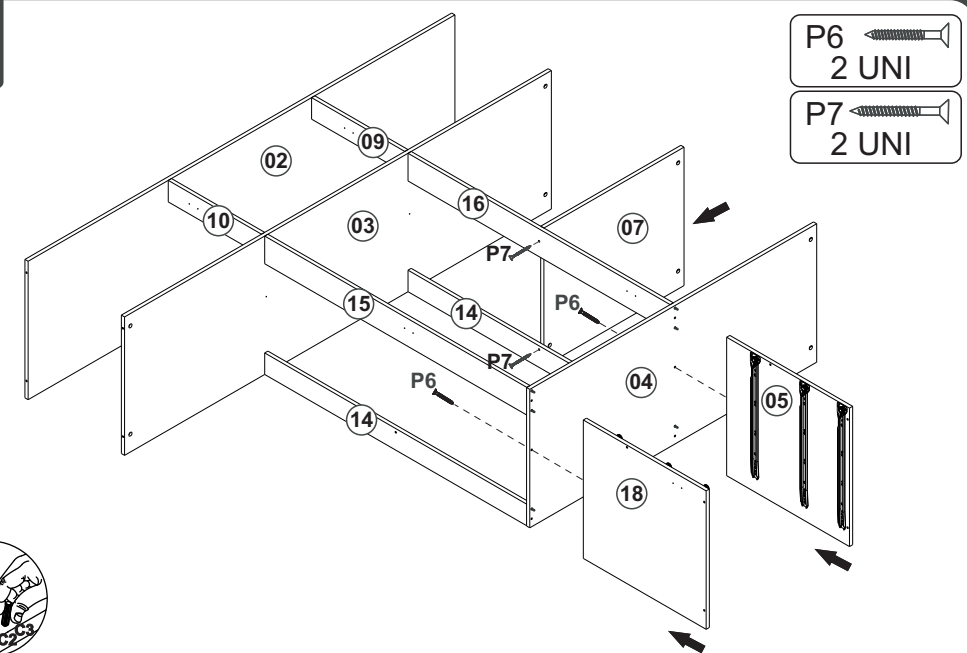

# RP3634 - ROUPEIRO

Manual de Montagem  
 Assembly Instructions  
 Instrucción de Montaje



05°

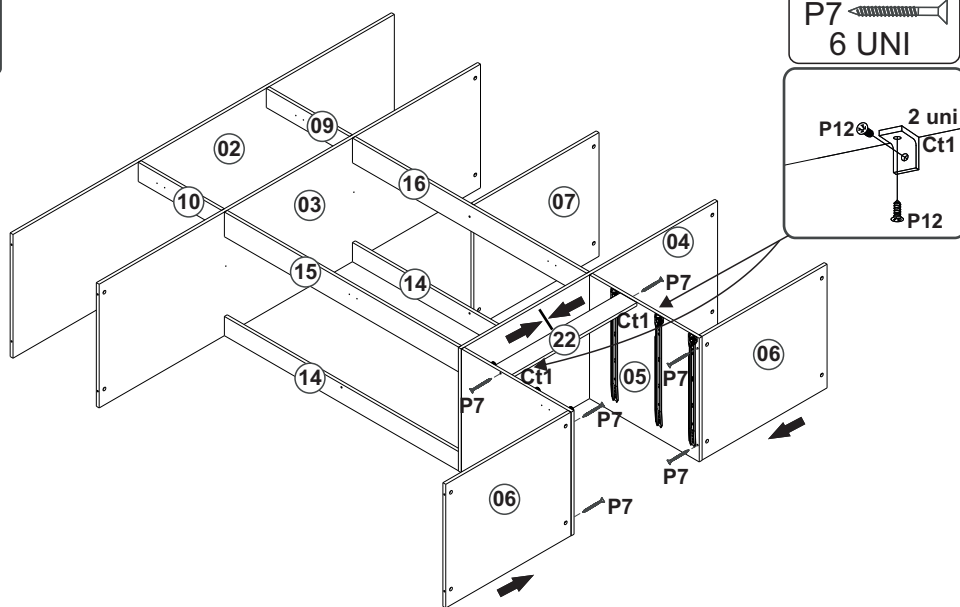

06°

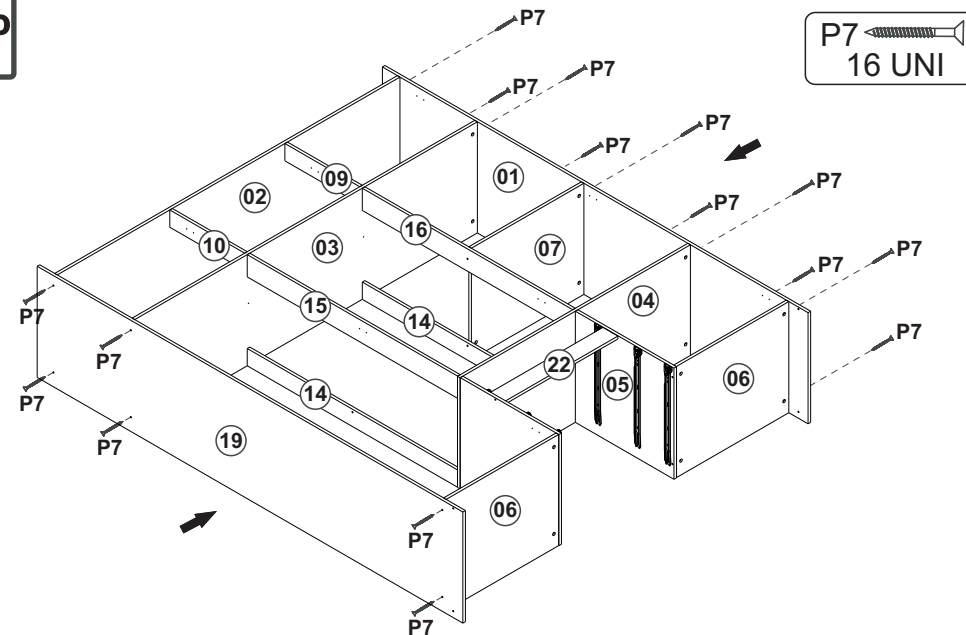

07°

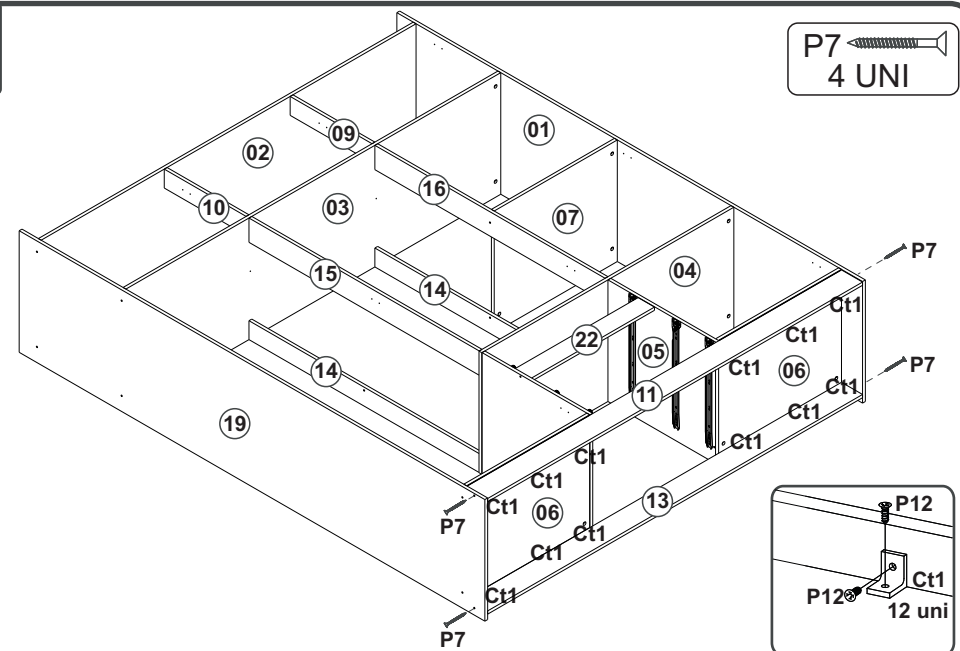

08°

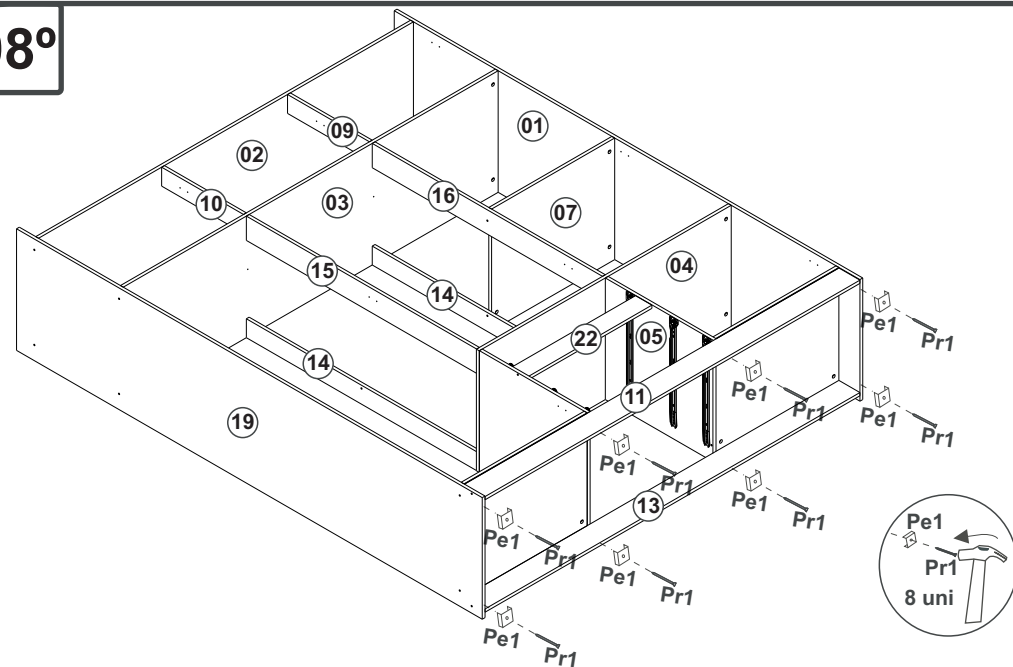

# RP3634 - ROUPEIRO

Manual de Montagem  
 Assembly Instructions  
 Instrucción de Montaje



09°

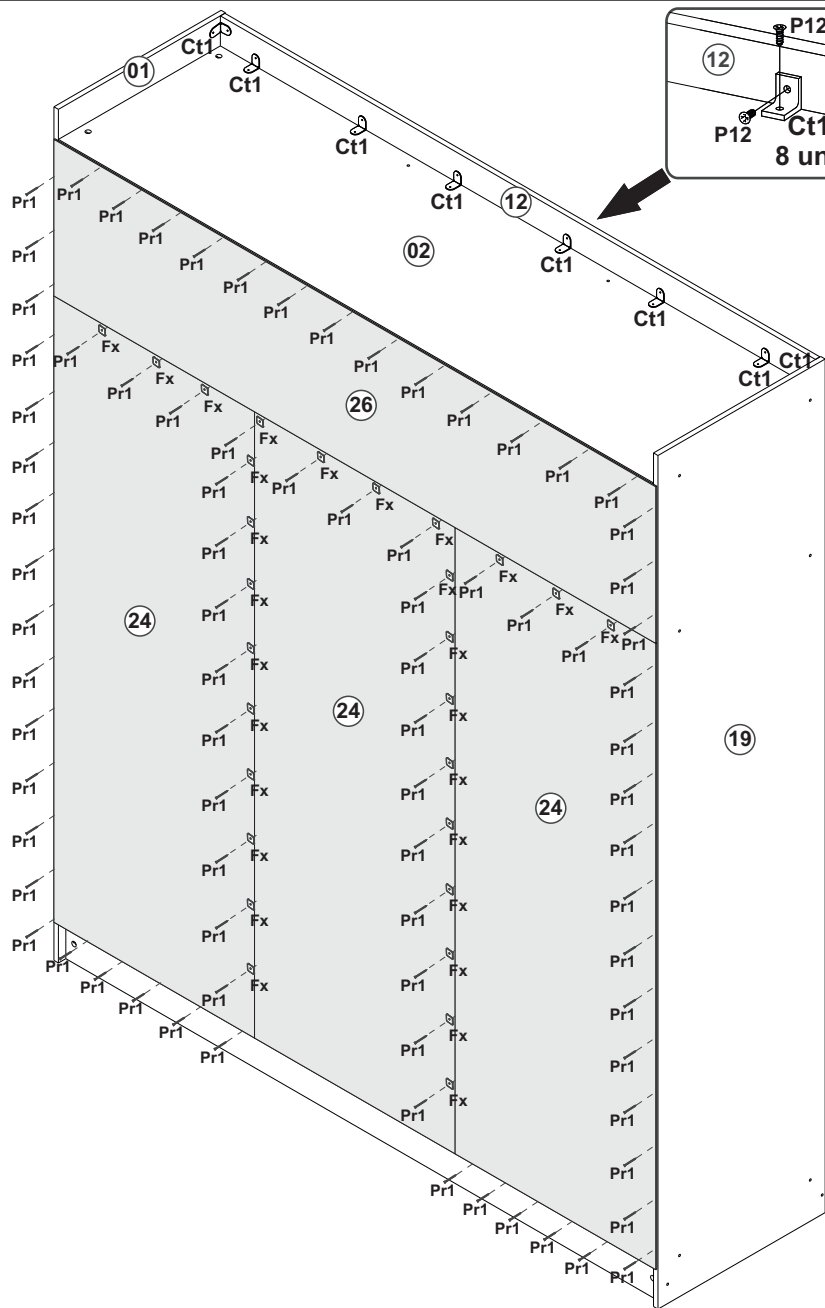
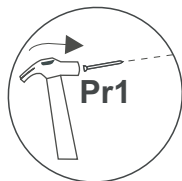

10°

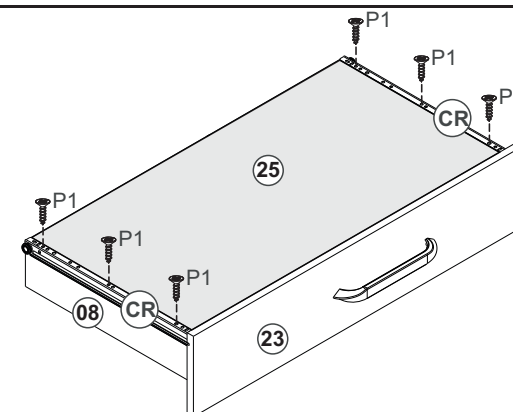
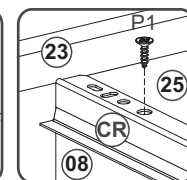
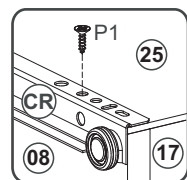
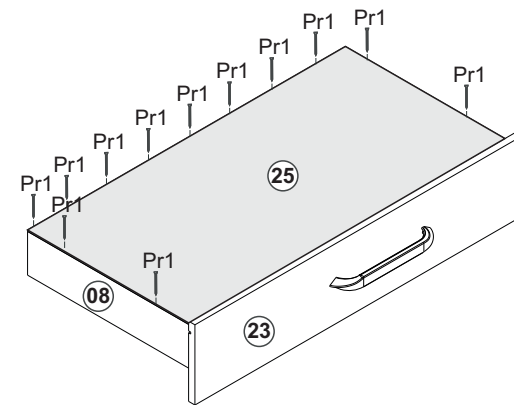
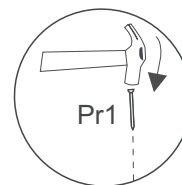
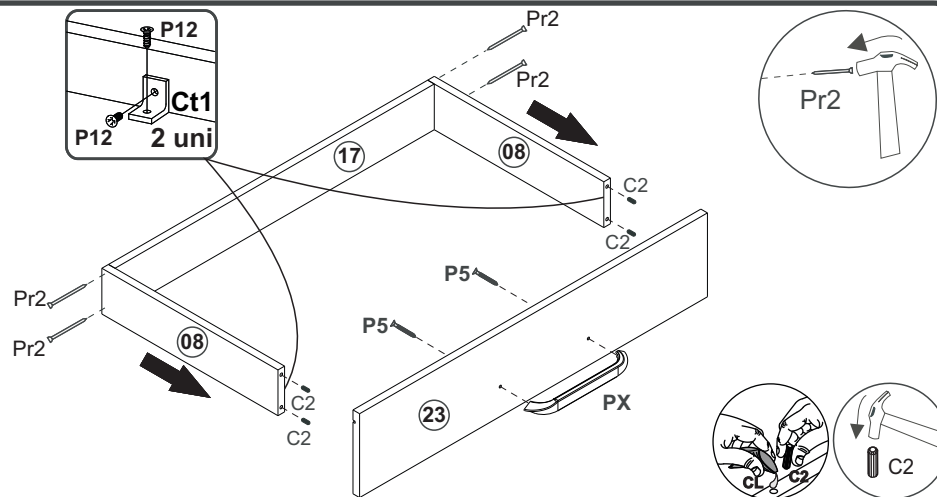

# RP3634 - ROUPEIRO

Manual de Montagem  
 Assembly Instructions  
 Instrucción de Montaje

decibal<sup>®</sup>  
 móveis

11°

PESO SUPORTADO/PESO SOPORTADO/ WEIGHT SUPPORTED

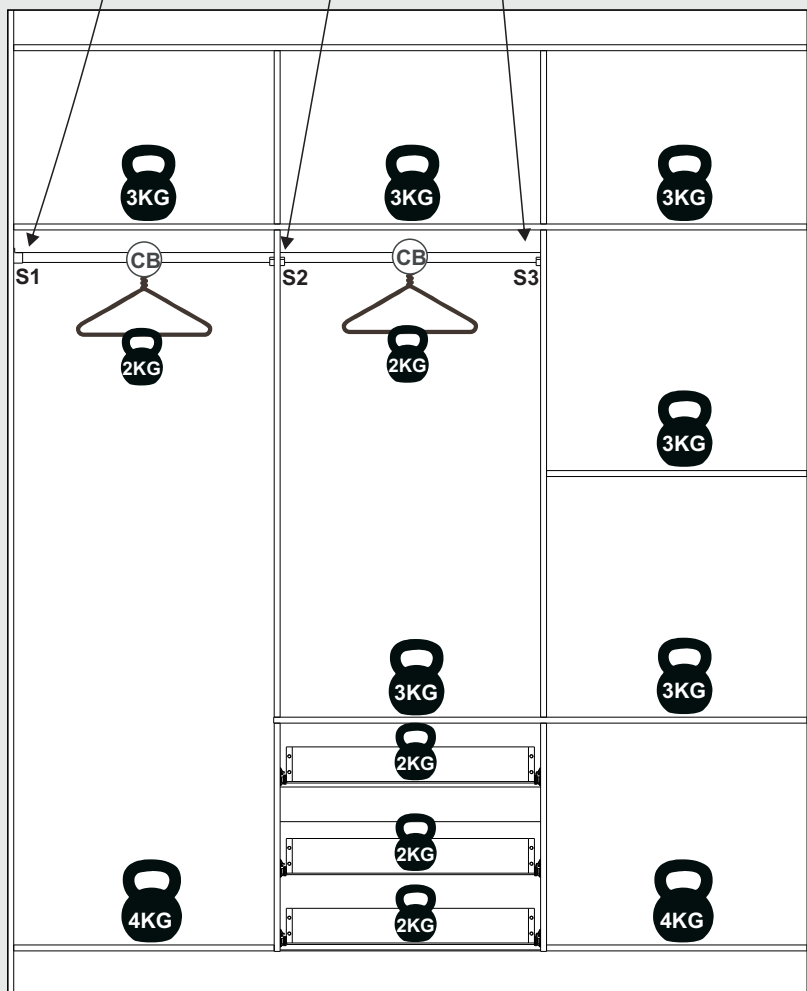
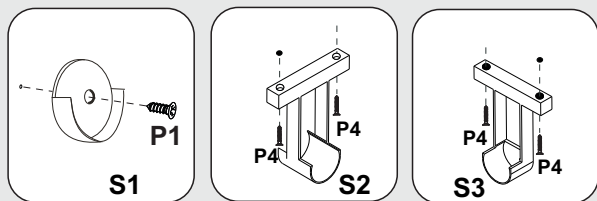

12°

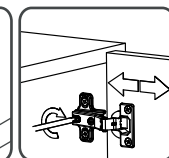
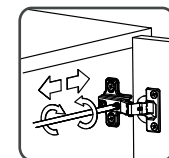
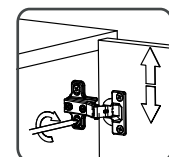
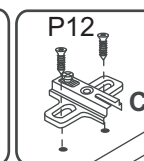
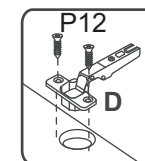
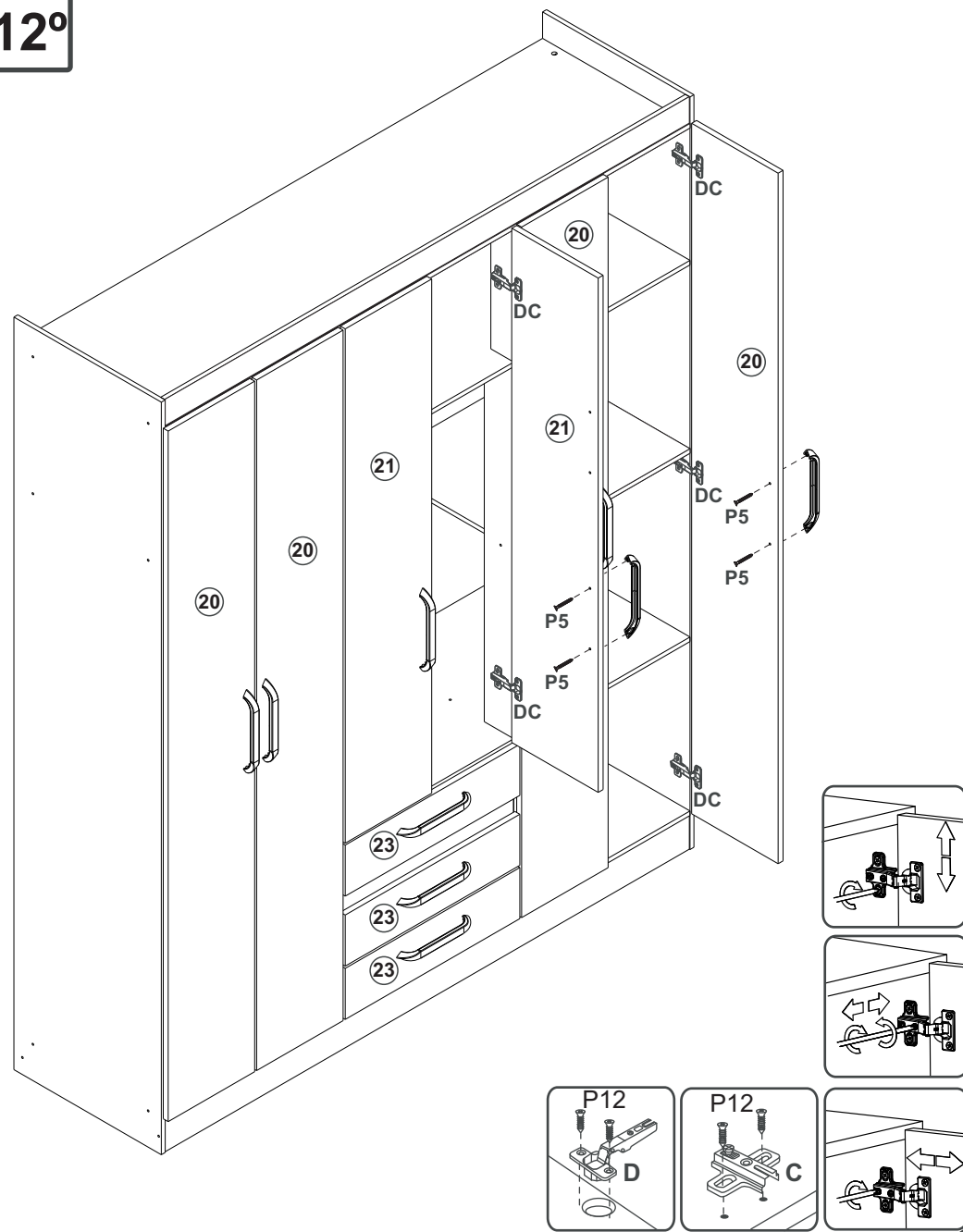

# RP3634 - ROUPEIRO

Manual de Montagem  
Assembly Instructions  
Instrucción de Montaje

decibal<sup>®</sup>  
móveis

13



Sugestão de medida.  
Sugerencia de medición.  
Measurement suggestion.

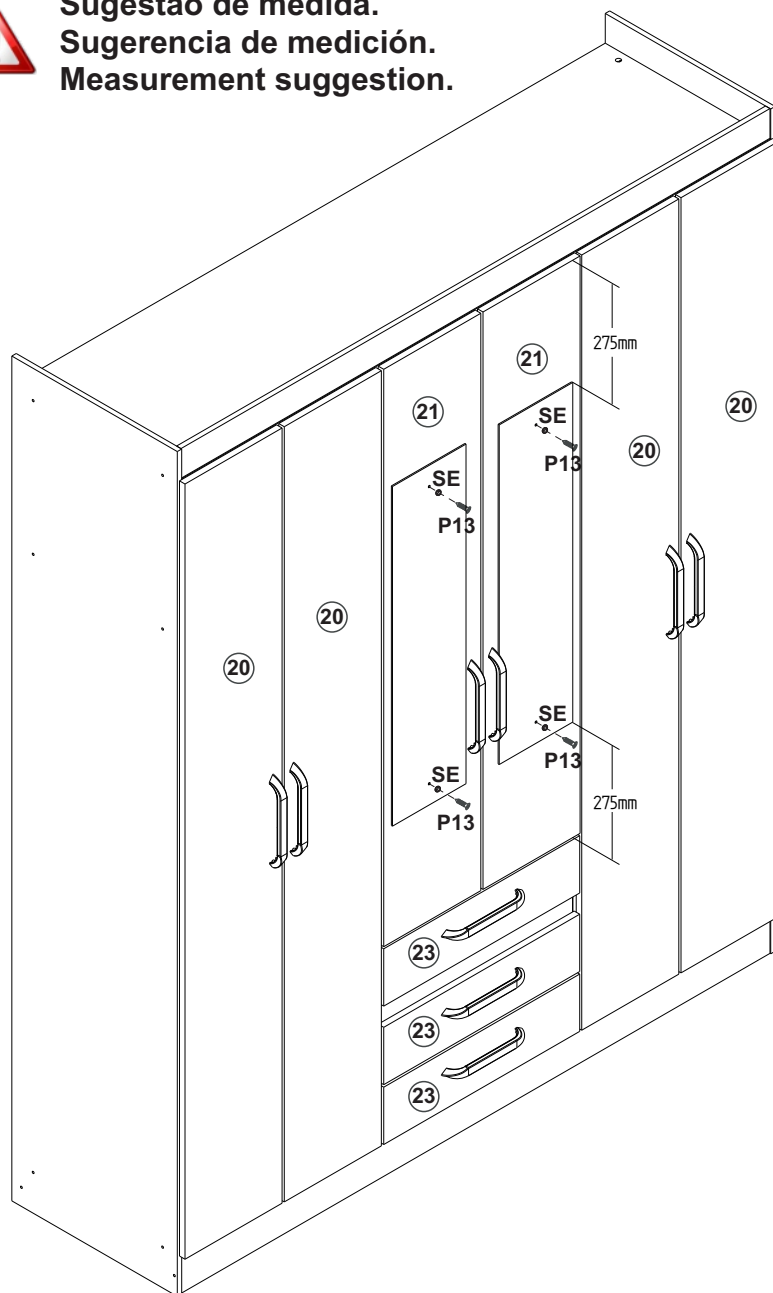

**ATENÇÃO!!!! montadores e consumidores**  
\* Ajustar o torque da parafusadeira para não danificar as peças escareando o parafuso \*  
**ATENCIÓN!!!! montadores e consumidores**  
\* Ajuste el torque del destornillador para no dañar las piezas avallanando el tornillo \*  
**ATTENTION!!!! assemblers and consumers**  
\* Adjust the torque of the screwdriver so as not to damage the parts by countersinking the screw \*

Ferramentas necessárias  
Necessary tools  
Herramientas necesarias

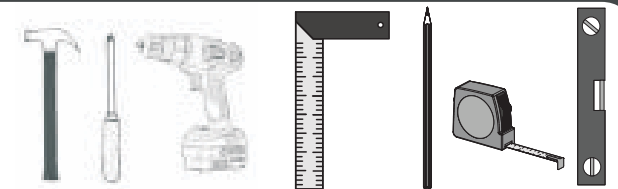

[www.decibal.com.br](http://www.decibal.com.br)

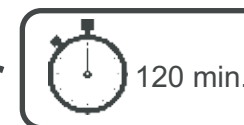

120 min.



2 montador  
2 ajustador  
2 Fitter

**ATENÇÃO!!!! montadores e consumidores**

\* Para limpar o móveis utilize somente um pano úmido (umedecido em água pura ou água com sabão neutro). Depois, passe um pano seco. Evite a umidade excessiva.  
\* Evite usar álcool, água sanitária, detergente e outros produtos químicos, mesmo diluídos em água. Não utilize produtos abrasivos de nenhuma espécie

**ATENCIÓN!!!! montadores e consumidores**

\* Para limpiar el mueble utilice solamente un paño húmedo (humedecido con agua limpia o con un jabón suave). A continuación, utilice un paño seco. Evite el exceso de humedad.  
\* Evite uso de alcohol, hipoclorídrico solución basada, detergente y otros productos químicos, mismo diluídos en agua. No utilice productos abrasivos de ningún tipo.

**ATTENTION!!!! assemblers and consumers**

\* To clean the furniture, use only a damp cloth (humidify it only in pure water ou water and neutral soap). After, use a dry cloth. Avoid excessive humidity.  
\* Avoid using alcohol, bleach, detergent and other chemical products, even diluted in water. Do not use any kind of abrasive cleaning agents to clean the furniture.  
The use of such products may jeopardize the ?nal characteristics of the furniture.

# RP3634 - ROUPEIRO







Manual de Montagem  
Assembly Instructions  
Instrucción de Montaje

**decibal**<sup>®</sup>  
móveis

## Relação de Peças/ Relación de Piezas/Parts List

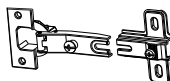
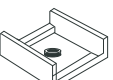
Nº	CÓDIGO/CODE	DESCRIÇÃO/DESCRIPCIÓN/DESCRIPTION	QTD/CANT	VOL.	
1	0560611	LATERAL DIR/LATERAL/SIDE	1990X450X12MM	1	1
2	0560610	BASE SUP	1602X450X12MM	1	1
3	0560613	BASE INT	1602X450X12MM	1	1
4	0560614	PRAT GAV/ESTANTE/SHELF	1077X450X12MM	1	1
5	0560616	DIVISORIA DIR/DIVIDER	461X450X12MM	1	1
6	0560615	BASE INF	526X450X12MM	2	1
7	0560623	PRAT/ESTANTE/SHELF	526X450X12MM	1	1
8	0560631	LATERAL GAVETA/LATERAL CÁJON/DRAWER SIDE	350X70X12MM	6	1
9	0560621	PILASTRA SUP DIR/PILLASTER	350X70X12MM	1	1
10	0560622	PILASTRA SUP ESQ/PILLASTER	350X70X12MM	1	1
11	0560624	RODAPÉ FRT/ZÓCALO/BASEBOARD	160X90X12MM	1	1
12	0560626	RODA FORRO/WHEEL LINING/RUEDA DE FORRO	1602X70X12MM	1	1
13	0560625	RODAPÉ TRS/ZÓCALO/BASEBOARD	1602X90X12MM	1	1
14	0560620	PILASTRA TRS/PILLASTER	984X70X12MM	2	1
15	0560619	PILASTRA FRT ESQ/PILLASTER	984X90X12MM	1	1
16	0560618	PILASTRA FRT DIR/PILLASTER	984X90X12MM	1	1
17	0560632	BATENTE/RÉVES CÁJON/DRAWER BACK	477X70X12MM	3	1
18	0560617	DIVISORIA ESQ/DIVIDER	461X450X12MM	1	1
19	0560612	LATERAL ESQ/LATERAL/SIDE	1990X450X12MM	1	1
20	0560627	PORTA MAIOR/PUERTA/DOOR	1826X264X15MM	4	2
21	0560630	PORTA MENOR/PUERTA/DOOR	1360X264X15MM	2	2
22	0560629	TRAVESSA FRT/TRAVIESSA/TRVERSE	526X70X12MM	1	2
23	0560628	FRENTE GAVETA/FRENTE CÁJON/DRAWER FRONT	533X135X15MM	3	2
24	0560634	COSTA MAIOR/REVÉS/BACK	1460X540X2,8MM	3	2
25	0560633	FUNDO GAVETA/FONDO CÁJON/DRAWER BOTTOM	500X355X2,8MM	3	2
26	0560635	COSTA MENOR/REVÉS/BACK	1602X365X2,8MM	1	2

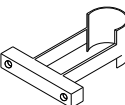
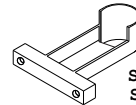
## Escala (N/A)











LEGENDA	DESCRIÇÃO/DESCRIPCIÓN/DESCRIPTION	CÓDIGO	QUANT.
<b>CL</b>	 COLA/PEGAMENTO/GLUE	01213	<b>01</b>
<b>Ct1</b>	 CANTONEIRA/PIEZA L/SHEET	03077	<b>28</b>
<b>DC</b>	 DOBRADIÇA/BISAGRA/HINGE D=26mm C=5mm	01268	<b>16</b>
<b>PE</b>	 PÉ/PATA/FOOT	01367	<b>08</b>
<b>CB</b>	 CABIDEIRO/ROLIZO PERCHA/ROD FOR HANGERS 530 MM	12394	<b>02</b>
<b>S1</b>	 SUPORTE CABIDEIRO/SOPORTE PERCHERO SUPPORT TO HANGER SUPPORT	02033	<b>01</b>
<b>S2</b>	 SUPORTE CABIDEIRO/SOPORTE PERCHERO SUPPORT TO HANGER SUPPORT	11897	<b>01</b>
<b>S3</b>	 SUPORTE CABIDEIRO/SOPORTE PERCHERO SUPPORT TO HANGER SUPPORT	04525	<b>01</b>
<b>SE</b>	 SUPORTE ESP/APOYOSUPPORT	01371	<b>04</b>
<b>E</b>	 ESPELHO/ESPEJO/MIRROR 800X200X3MM	01282	<b>04</b>

# RP3634 - ROUPEIRO

Manual de Montagem  
Assembly Instructions  
Instrucción de Montaje

**decibal**<sup>®</sup>  
móveis





## Escala (1:1)

LEGENDA	DESCRIÇÃO/DESCRIPCIÓN/DESCRIPTION	CÓDIGO	QUANT.
<b>P7</b>	 PARAFUSO/TORDILHO/SCREW 4X45	01318	<b>28</b>
<b>Pr1</b>	 PREGO/CLAVO/NAIL 10X10	01330	<b>160</b>
<b>Pr2</b>	 PREGO/CLAVO/NAIL 13X15	01329	<b>12</b>
<b>P6</b>	 PARAFUSO/TORNILLO/SCREW 4X35	02032	<b>12</b>
<b>B</b>	BUCJA/BUJE/BUCHING 	02734	<b>28</b>
<b>C2</b>	 CAVILHA/TARUGO/DOWEL 6X30 MM	01211	<b>20</b>
<b>P1</b>	 PARAFUSO/TORNILLO/SCREW 3X12	01328	<b>38</b>
<b>P5</b>	 PARAFUSO/TORNILLO/SCREW 3,5X25	09955	<b>18</b>
<b>P12</b>	 PARAFUSO/TORNILLO/SCREW 3,5X13	09927	<b>120</b>
<b>C3</b>	 CAVILHA/TARUGO/DOWEL 6X50 MM	01212	<b>09</b>

## Escala (1:1)

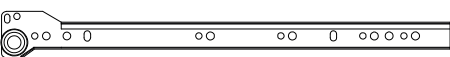
LEGENDA	DESCRIÇÃO/DESCRIPCIÓN/DESCRIPTION	CÓDIGO	QUANT.
<b>P4</b>	 PARAFUSO/TORNILLO/SCREW 4X20	03109	<b>04</b>
<b>P13</b>	 PARAFUSO/TORNILLO/SCREW 3,5X16	10224	<b>04</b>

## Escala (N/A)

LEGENDA	DESCRIÇÃO/DESCRIPCIÓN/DESCRIPTION	CÓDIGO	QUANT.
<b>CR</b>	 CORREDICA/CORREDERA/METALLIC LARG 350MM	01225	<b>03</b>
<b>PX</b>	 PUXADOR/PEGADOR/HANDLE(390.160 CROMADO FOSCO)	12472	<b>09</b>
<b>FX</b>	 FIXADOR COSTA/FIJADOR FONDO/FIXER COAST	01331	<b>46</b>
<b>ET</b>	 ETIQUETA LOGO DECIBAL/LABEL DECIBAL	01312	<b>01</b>
<b>AD</b>	 ADESIVO/ADHESIVO/ADHESIVE 15mm	Wood 09929 Branco 03379	<b>20</b>

Medida em mm

