

# MANUAL DE MONTAGEM

## INSTRUCCIONES DE MONTAJE

### ASSEMBLY INSTRUCTIONS

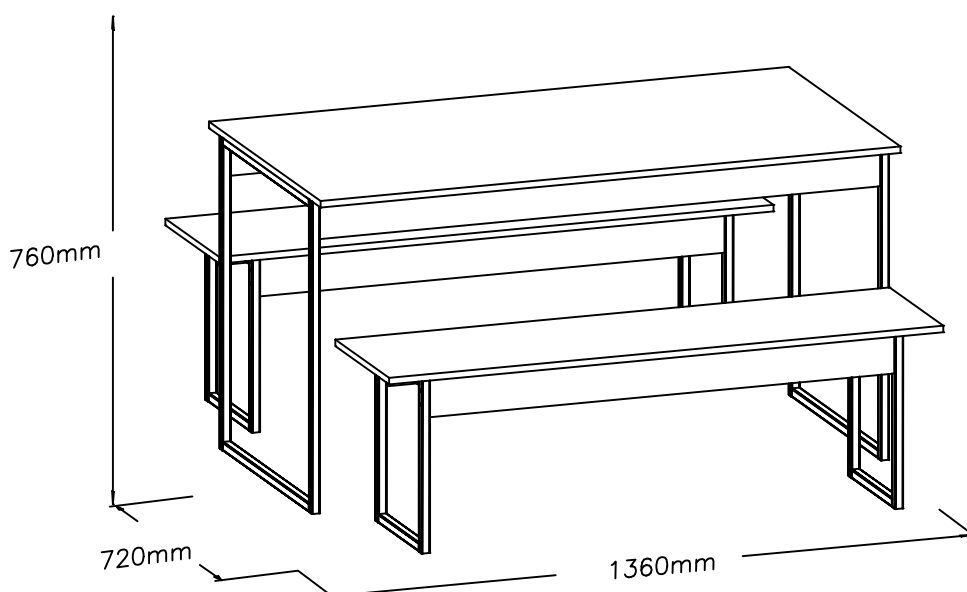

## ATENÇÃO / PRECAUCIÓN / ATTENTION:

- 1 – Ler atentamente todo o manual antes de iniciar a montagem do móvel.
  - 2 – A montagem deve ser feita em uma superfície plana e limpa.
  - 3 – Recomenda-se utilizar a embalagem do móvel para forrar e chão e assim não danificá-lo.
- 1 – Lea cuidadosamente todo el manual antes de comenzar el montaje.
  - 2 – La instalación debe hacerse sobre una superficie plana y limpia.
  - 3 – Es recomendado ser utilizado para empaquetar móvil a la línea y tierra y por lo tanto dañar ellos.
- 1 – Read the entire manual carefully before starting the furniture assembly.
  - 2 – The assembly must be done on a flat and clean surface.
  - 3 – It is recommended to use the packaging of the furniture to cover and floor and thus not to damage them.

## LIMPEZA E CONSERVAÇÃO / LIMPIEZA Y CONSERVACIÓN / CLEANLINESS AND CONSERVATION:

A limpeza do móvel deve ser feita com utilização de pano umedecido com água, podendo conter uma pequena quantidade de álcool. Não utilize produtos abrasivos.

La unidad de limpieza se debe realizar con el uso de paño humedecido con agua y puede contener una pequeña cantidad de alcohol. No utilice productos abrasivos.

The furniture should be cleaned with a cloth dampened with water and may contain a small amount of alcohol. Do not use abrasive products.

## GARANTIA / GARANTÍA / WARRANTY:

90 dias para defeitos de fabricação.

90 días a defectos de fabricación.

90 days for manufacturing defects.

## FERRAMENTAS NECESSÁRIAS / HERRAMIENTAS NECESARIAS / TOOLS REQUIRED:

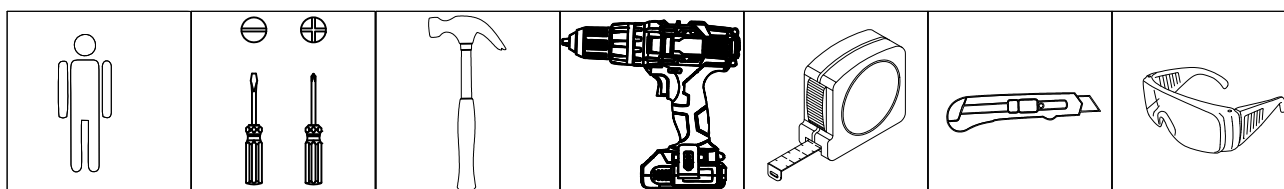

Acesse as dicas de  
montagem no Youtube

Accede a los consejos de  
montaje en Youtube.

Access the mounting tips on  
Youtube.







[www.youtube.com/MoveisKappesberg](http://www.youtube.com/MoveisKappesberg)

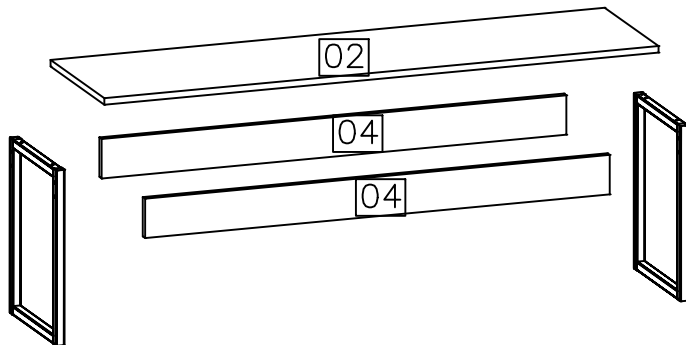
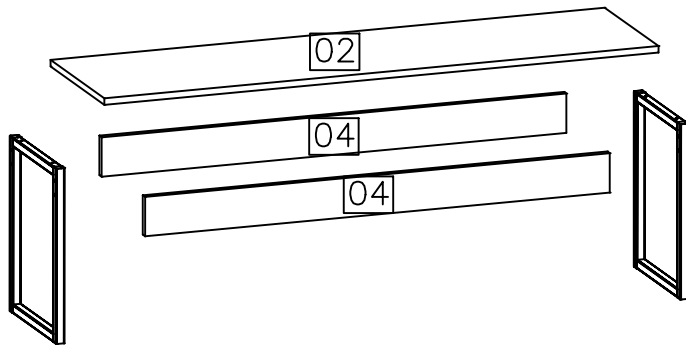
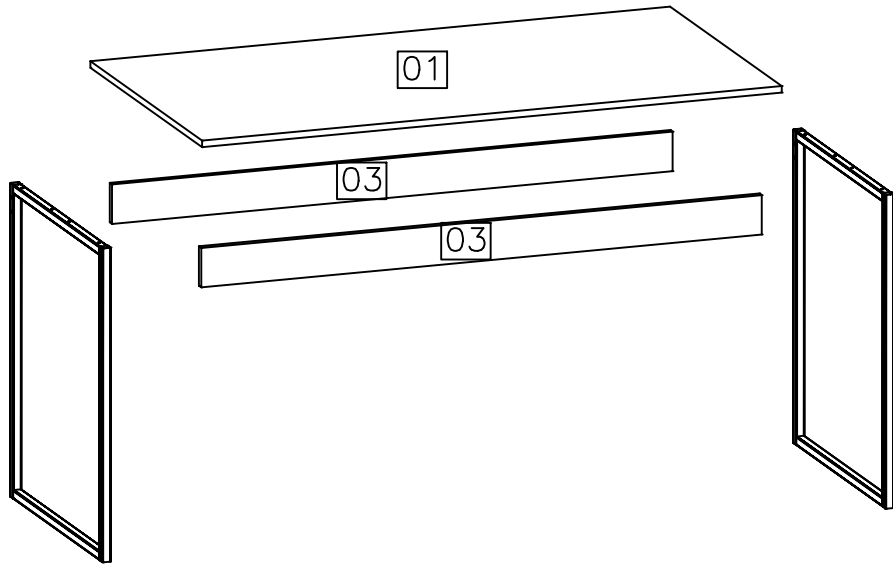

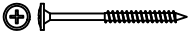
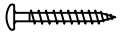
Lista de peças / Lista de piezas / List of pieces

Código/ Código/ Code	Descrição	Descripción	Description	Quantidade/ Cantidad/ Amount	Comprimento/ Longitud/ Length (mm)	Largura/ Ancho/ Width (mm)	Espessura/ Espesor/ Thickness (mm)	Caixa/ Caja/ Box
01	Tampo da mesa	Panel de mesa	Table top	1	1360	720	15	A
02	Tampo do banco	Panel de banco	Top panel	2	1300	347	15	A
03	Reforço da mesa	Refuerzo de mesa	Table reinforcement	2	1315	90	15	A
04	Reforço do banco	Fortalecimiento del banco	Strengthening of the bank	4	1090	90	15	A

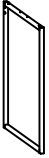

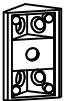

Ferragem / Herrajes / Hardware			
	Código/ Código/ Code	Descrição / Descripción / Description	Quan. / Cant. / Amou.
PF12	59672	 Parafuso flange/Tornillo/ Screw 5,0x50 ZP	24
PP10	58731	 Parafuso/ Tornillo/ Screw 4,0X30 ZP	16
PC3	4214	 Parafuso/ Tornillo/ Screw 3,5X14	48
EM	58	 Etiqueta marca/Tag label "Kappesberg"	1
SA	58639	 Sapata regulável/Zapato/ Shoe 1/4x20	12
BR	58638	 Bucha/Casquillo de tornillo/Screw bushing 20x20	12
E1	59129	 Estrutura Estructura Structure	2
E2	59130	 Estrutura Estructura Structure	4
CG	899	 Cantoneira /Cantón/Angle bracket	12
01 Saco-07			



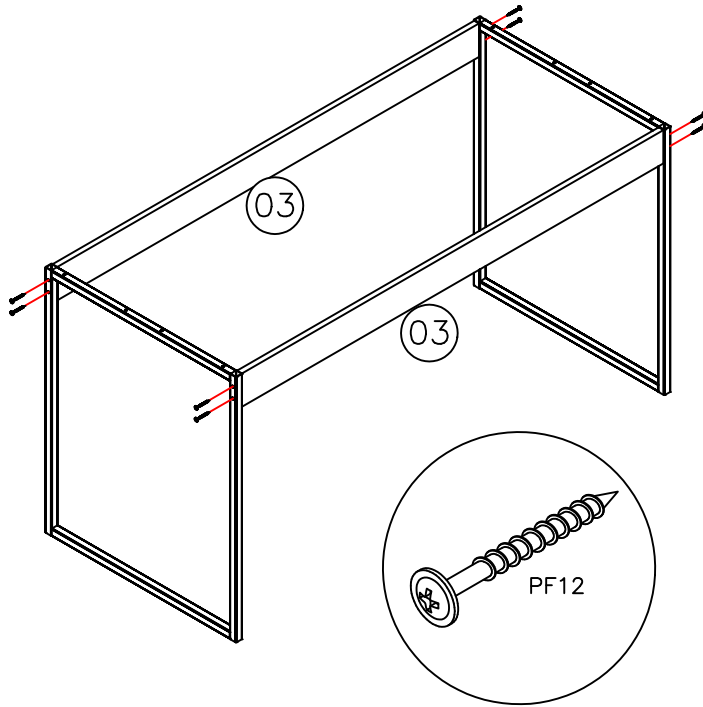



01

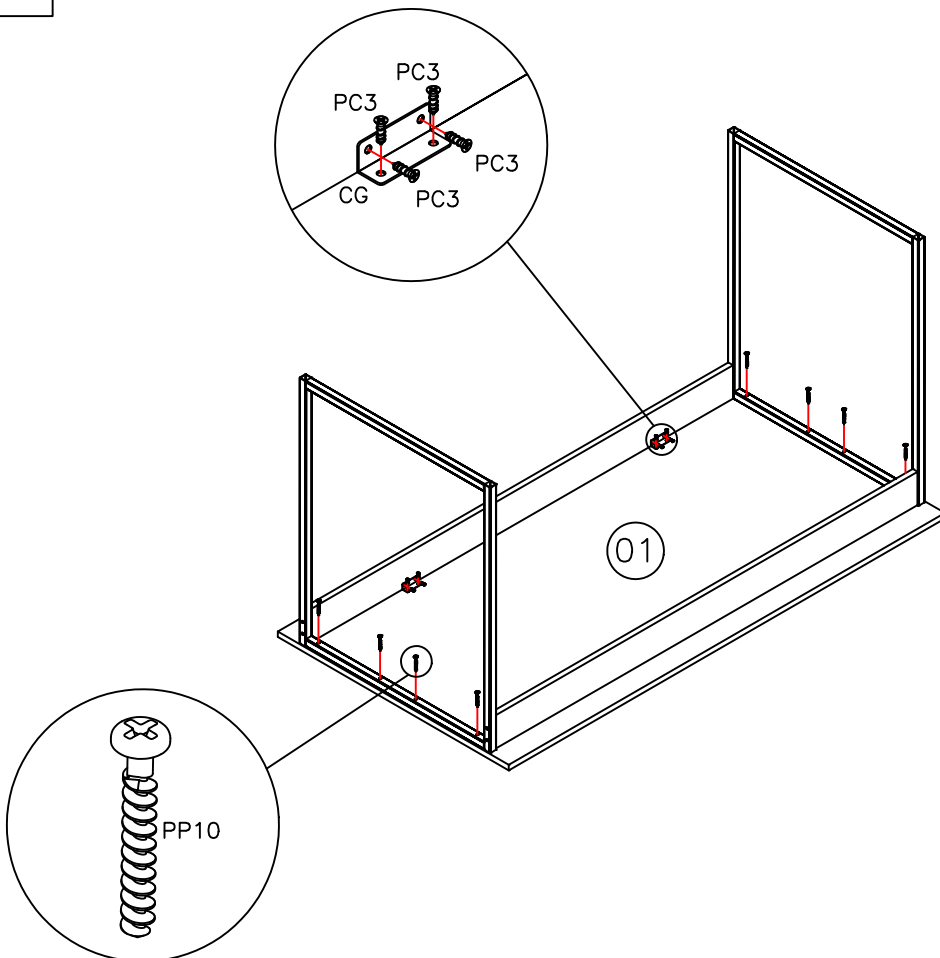

PF12		8
E1		2

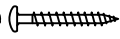
02

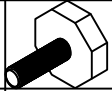

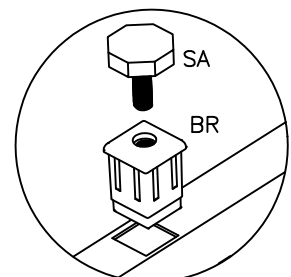

PP10		8
PC3		16
CG		4
SA		4
BR		4



03

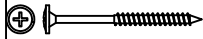

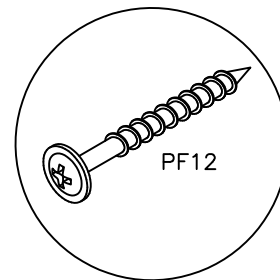
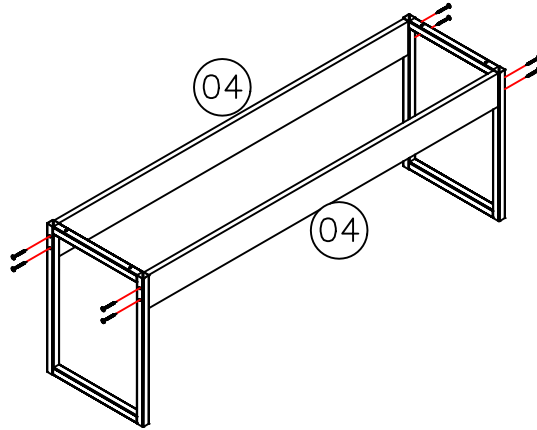

2x

PF12		16
E2		4

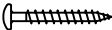

04

2x

PP10		8
PC3		32
CG		8
SA		8
BR		8

