

Montagem/Montaje

04

ATENÇÃO!!!

É importante colocar o móvel no esquadro antes de fixar as costas. Para isto utilize uma trena observando que a medida 1 deve ser igual à medida 2.

ATENCIÓN!!!

Es importante hacer una escuadra perfecta entre el fondo y la estructura del mueble. Observe que la medida 1 debe ser la misma que la medida 2.

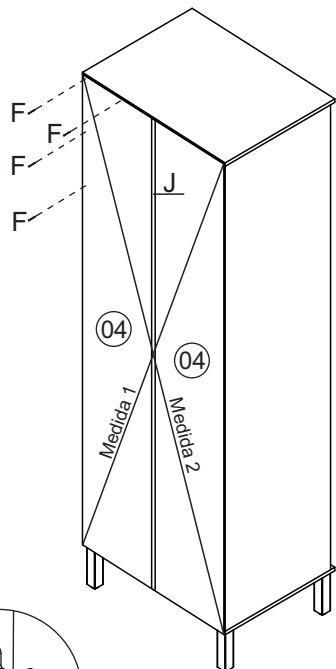

05

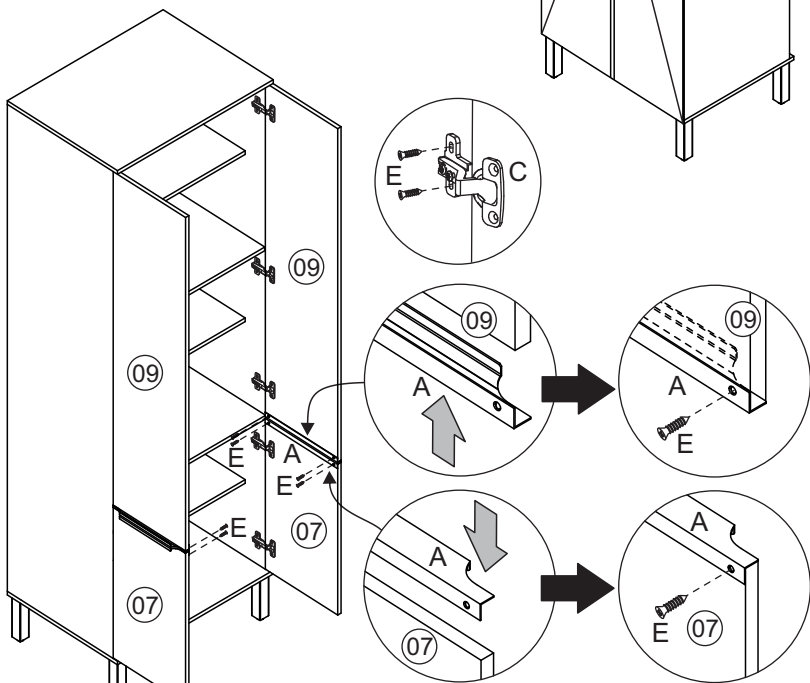

*Usar os outros 4 parafusos (D) para unir este módulo a outro.

Usar los otros tornillos (D) para unirse este modulo a otro.

Limpeza/Limpieza

- ≠ Use um pano levemente umedecido com água, seguido de pano seco.
- ≠ Use solamente un paño húmedo con agua y después un paño seco.
- ≠ Nunca utilize produtos químicos ou abrasivos.
- ≠ No utilice productos químicos o abrasivos.

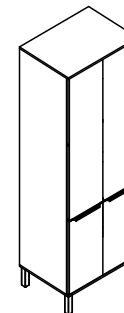

Ref. PVE02

Panelero 4P
Armario p/Ollas 4P
Cozinha/Cocina
Verace

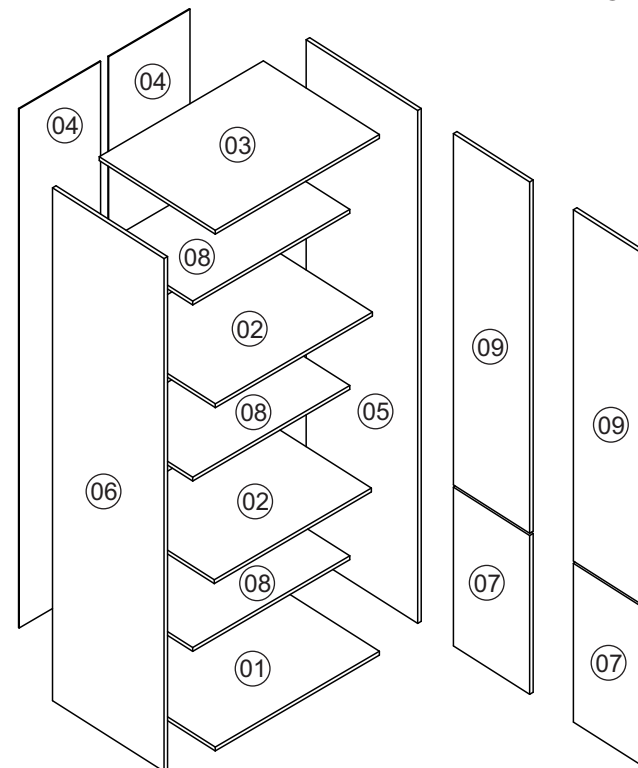

Nº	CÓDIGO ASSISTÊNCIA	NOME DA PEÇA/DESCRIPCIÓN PIEZAS	MEDIDAS (mm)	QTD.	CÓDIGO DAS PEÇAS/CÓDIGO PIEZAS					
					HAVANA	TAUPE	TAUPE	OFF WHITE	TITANIO	TAUPE
01	PVE02.01.00	Base inferior/Base inferior	700x516x15	01	54073		54091		54085	
02	PVE02.02.02	Base interna/Base	670x496x15	02	54074		54092		54086	
03	PVE02.05.00	Base superior/Base superior	700x516x15	01	54075		54093		54087	
04	PVE02.13.00	Forro/Revés	2014x347x2.5	02	47486		47486		47486	
05	PVE02.17.00	Lateral externa direita/Lateral derecha	1990x496x15	01	54076		54094		54088	
06	PVE02.18.00	Lateral externa esquerda/Lateral izquierda	1990x496x15	01	54077		54095		54089	
07	PVE02.25.01	Porta panel/Puerta	616x339x15	02		54078		54096		54078
08	PVE02.27.00	Prateleira interna/Repisa	670x400x15	03	47490		47490		47490	
09	PVE02.25.00	Porta panel/Puerta	1363x339x15	02	54079			54097		54079

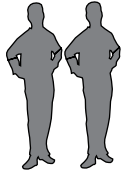

Ferragens/Herrajes

Código Qtde.

A		Puxador Manija	1816	04
B		4,0 x 50	12537	28
C			10269	10
D		3,5 x 25	692	08
E		4,0 x 14	667	66
F		8x8	822	80
G			12539	10
H		5,0 x 50	1979	04
I			1973	04
J		Perfil 2014mm	1799	01



Pré-Montagem/Preparación Piezas

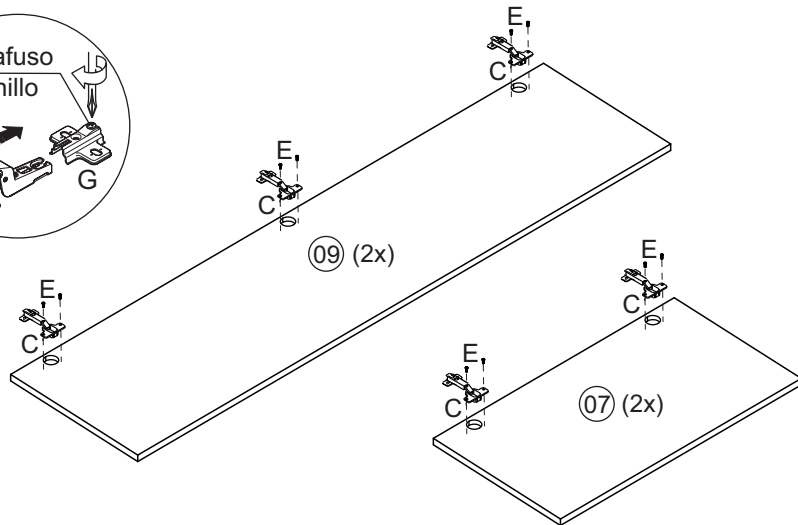

Montagem/Montaje

01

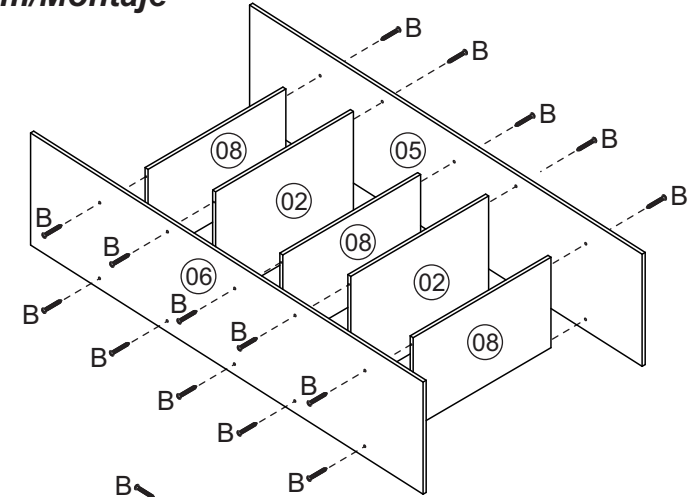

02

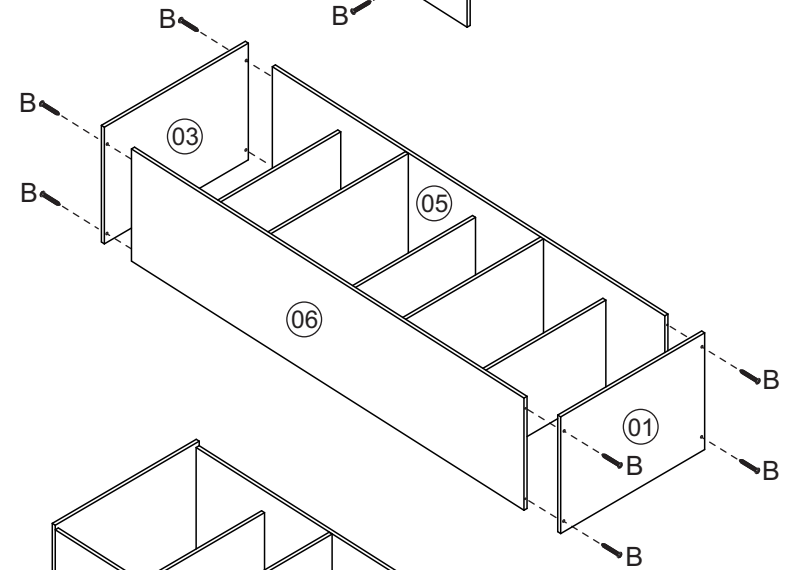

03

