

ATENÇÃO: No momento da entrega, verificar as condições da embalagem do produto, e caso a caixa esteja danificada, recusar o recebimento.

EMISSÃO: 30/11/2022
REVISÃO: 000 (30/11/2022)

INSTRUÇÃO DE MONTAGEM



**Mesa
Pé Balcão
Painel**



[Assista o Vídeo de Montagem](#)

Pandin

Peças

9573

01

Tampo Balcão



9575

01

Fundo Balcão



9594

02

Retaguarda Maior



9619

01

Perfil PVC Viga H



9577

02

Lateral Dir/Esq Arm



9579

02

Divisão Dir/Esq Arm



9581

01

Lateral Direito Gav



9583

01

Lateral Esquerda Gav



9598

02

Retaguarda Menor



9585

01

Prateleira Central



9587

01

Prateleira Externa



9983

01

Caixa Tomada Preto



9662

04

Perfil U



9590

01

Porta Direita



9592

01

Porta Esquerda



9599

04

Frente de Gaveta



Peças

9601



01

Travessa Fechadura

634



01

Fechadura Articulavel

3719



01

Retaguarda Mesa

1545



04

Corpo de Gaveta

594



04

Trilho Corrediça Par

4880



02

Puxador Aço

9604



01

Tranca Galvalume

9611



01

Tampo Mesa

9610



01

Suporte Fixação Ret

6183



01

Pé Dir/Esq Mesa

Kit

9966



05

Tapa Furo 12mm

5988



07

Suporte Fixação 14x20

7477



06

Suporte Fixação Pé

750



25

Tambor Girofix 15mm

694



23

Pino Girofix 6mm

825



69

Parafuso 4x14mm

831



08

Parafuso 3,5x22mm

833



08

Parafuso 4x25mm

838



04

Parafuso 4,5x50mm

840



29

Parafuso 6x10mm

844



16

Parafuso M4x0,6mm

892

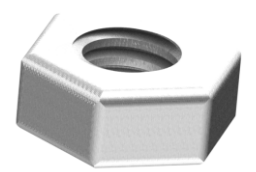

16

Porca Sextavada M4

699



04

Puxador Plástico

692



01

Fechadura 421

637

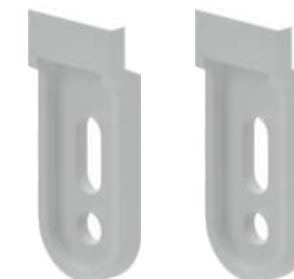

02

Kit Sis-Flex

873



08

Pé Nivelador 1/4x3/4

Kit

847



02

Parafuso 1/4x3/4

4839



02

Bucha Americana 1/4

925



08

Tapa Furo 12mm

935



16

Tapa Furo 18mm

1505



01

Suporte Aço Fixação

759

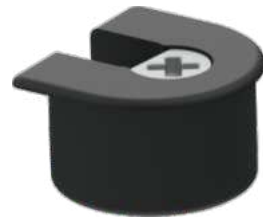

08

Dispositivo Vb35 M16

695



08

Pino Girofix VB Aa6

8965



04

Porca 12x60x0,18

910



01

Suporte Plastico 8/10

710



05

Bucha Americana

760



02

Espaçador

6105



02

Pino Girofix

9575

01

Fundo Balcão



01

7477

06

Suporte Fixação Pé

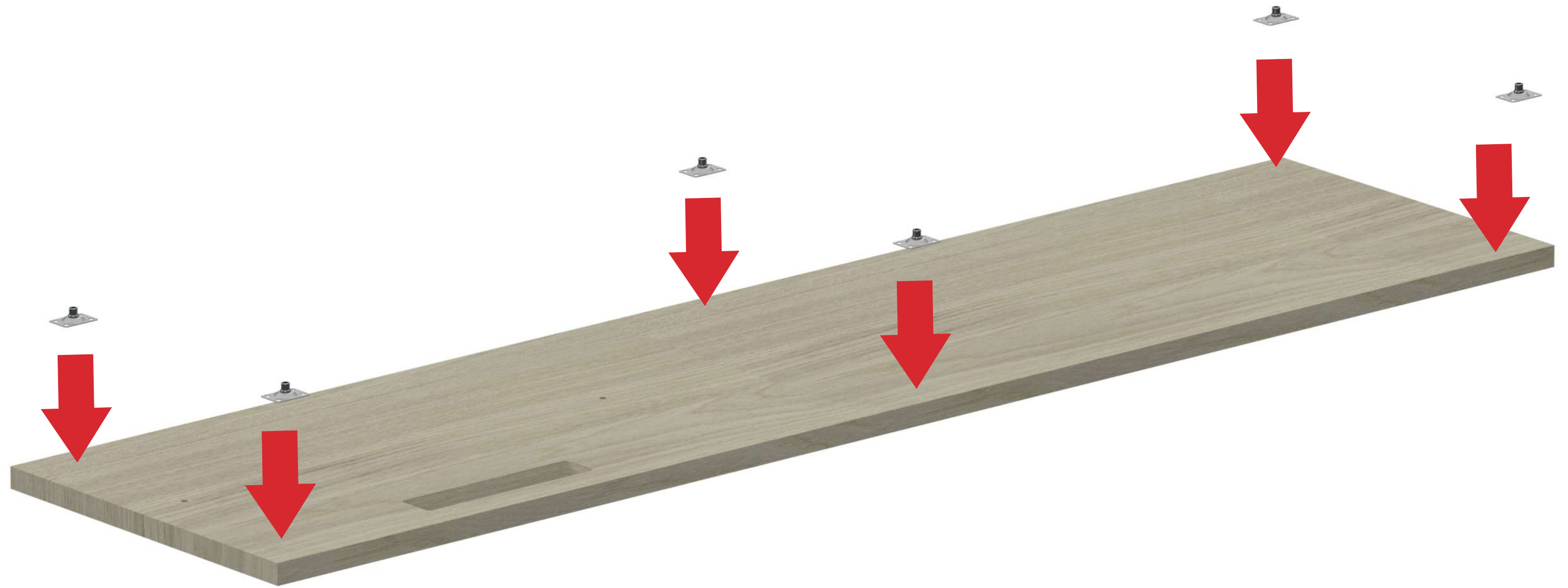

825

24

Parafuso 4x14mm

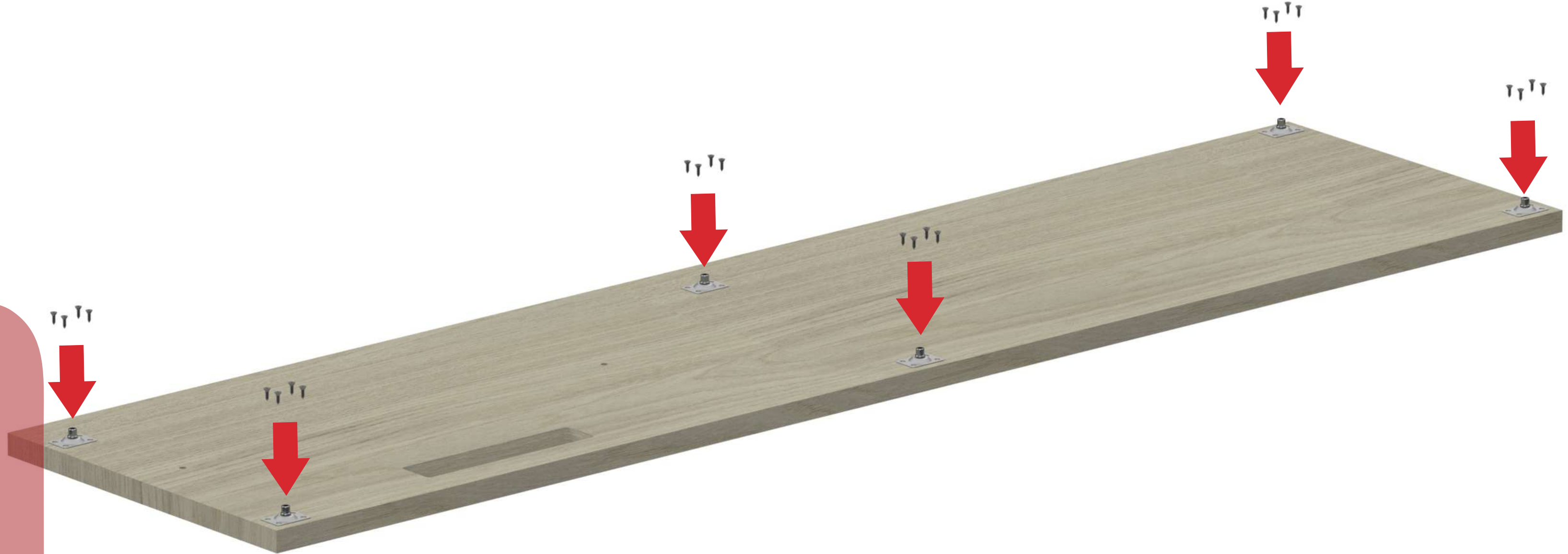

873



06

Pé Nivelador 1/4x3/4

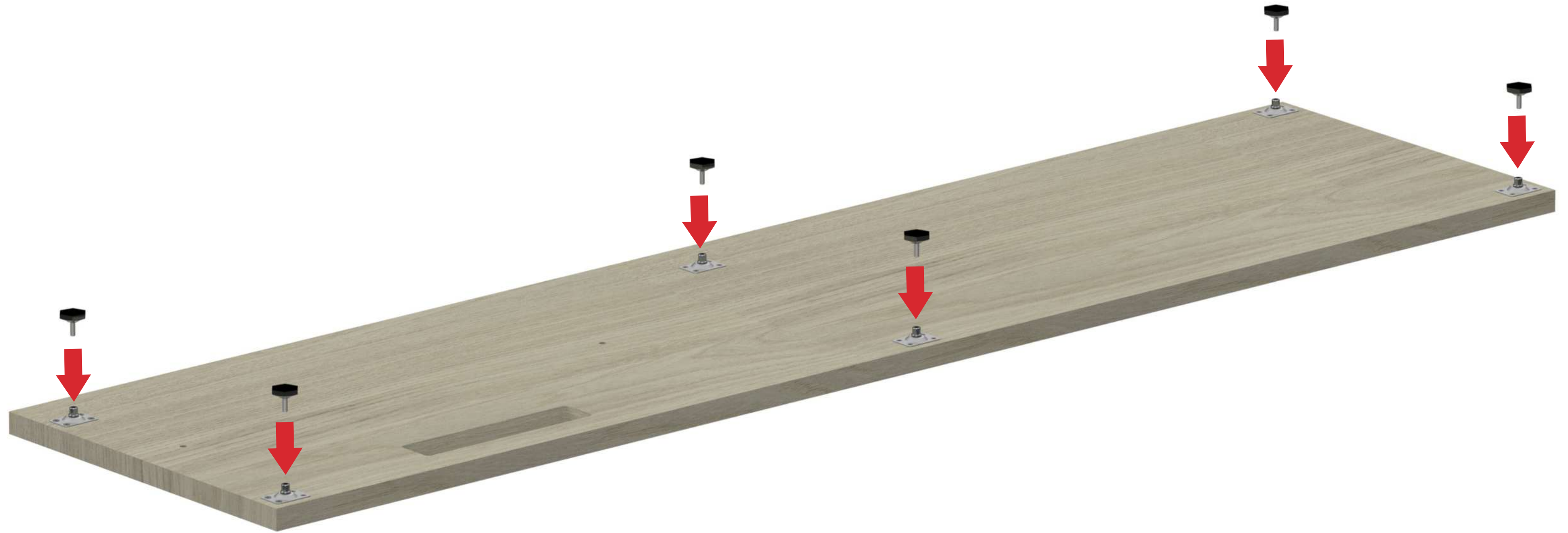



9662

04

Perfil U



694



05

Pino Girofix 6mm

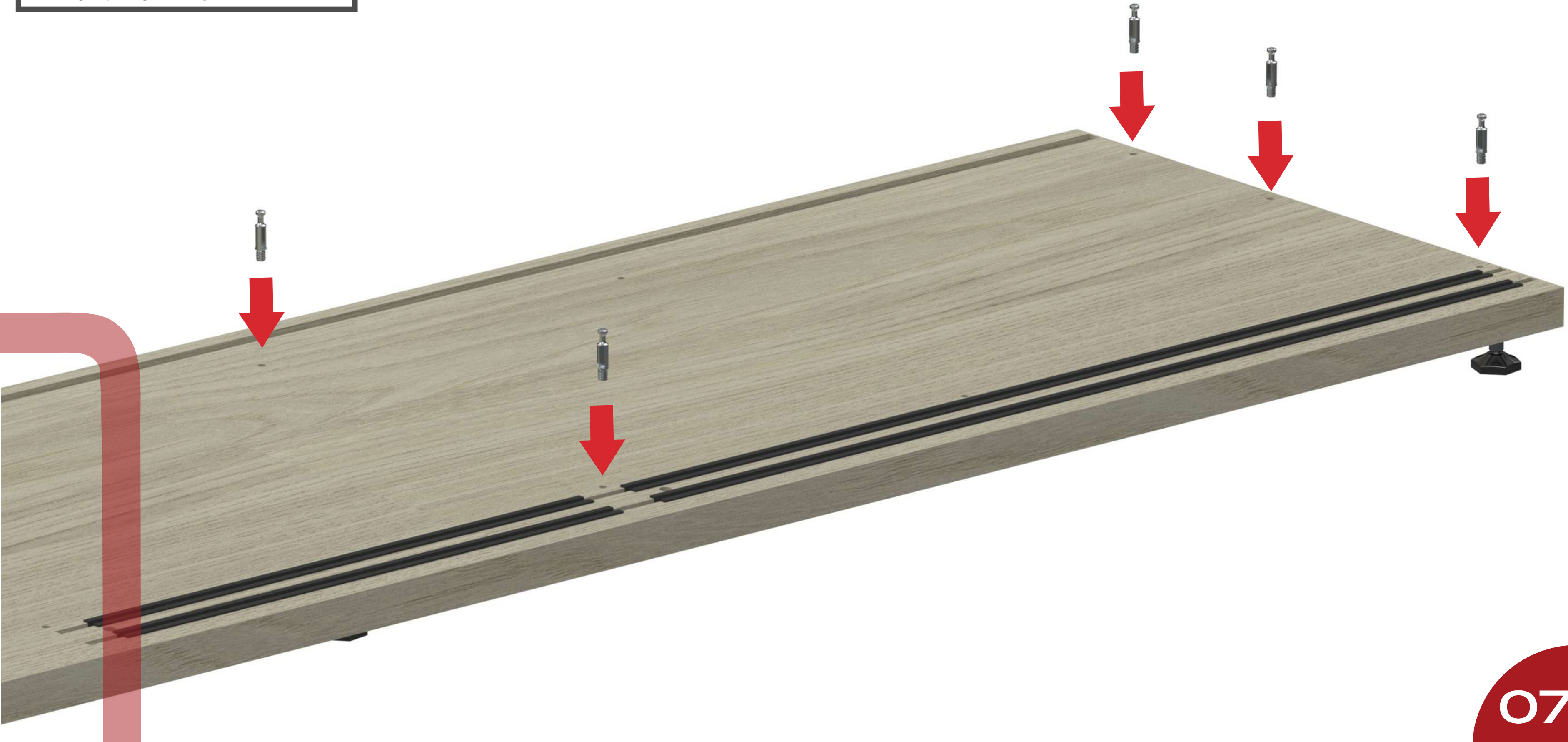

694



05

Pino Girofix 6mm



9577

01

Lateral Dir/Esq Arm

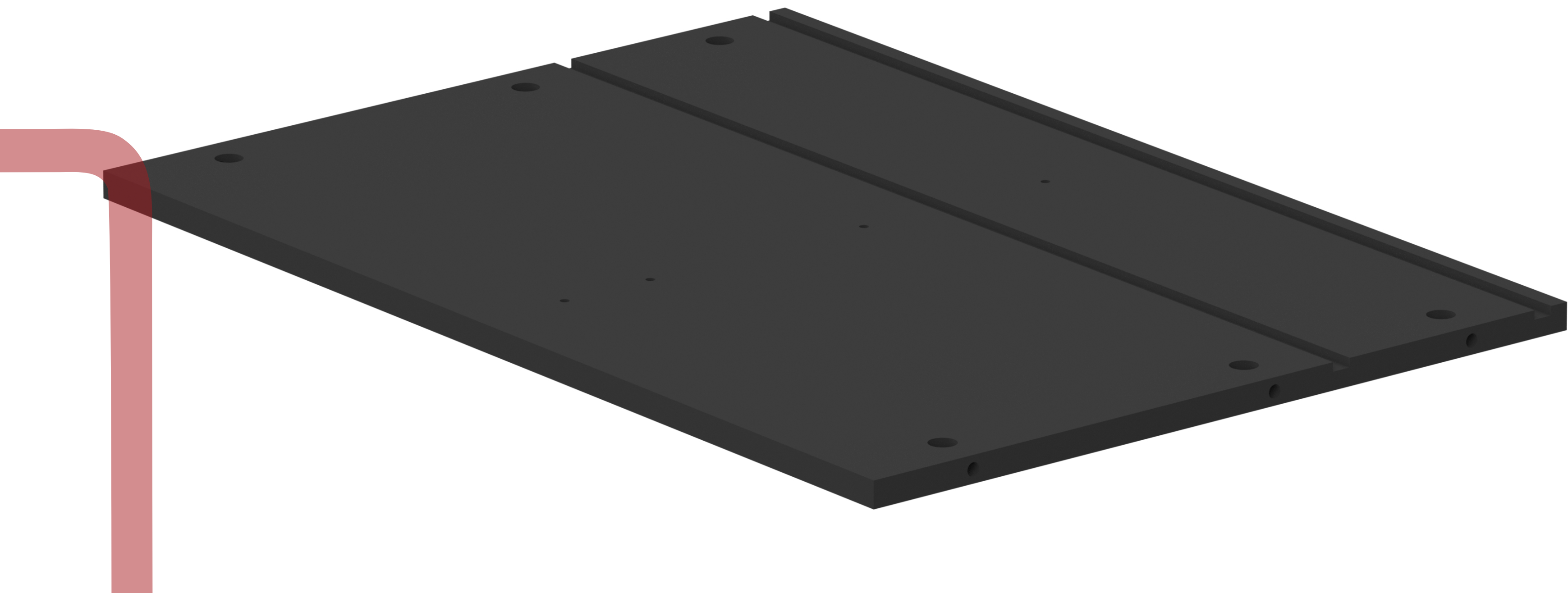

750
06



Tambor Girofix 15mm

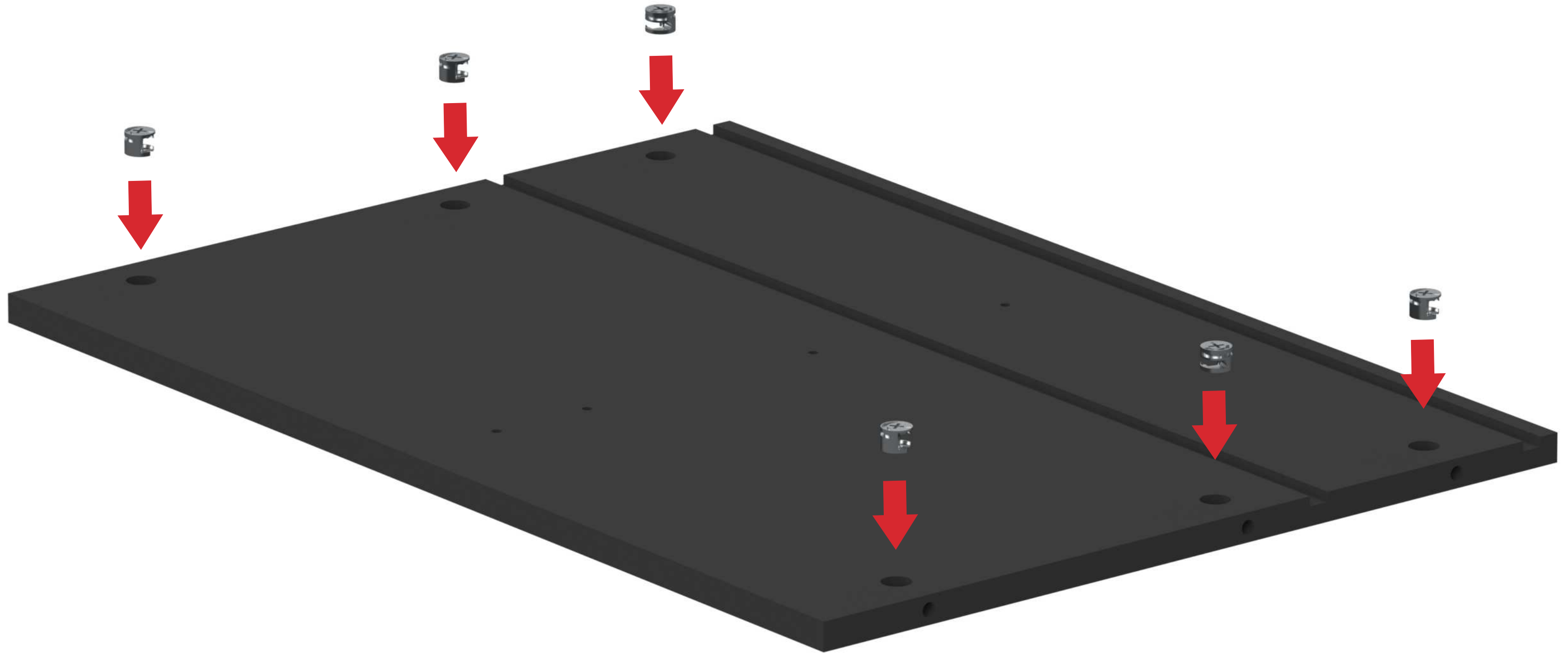

695

02

Pino Girofix VB Aa6

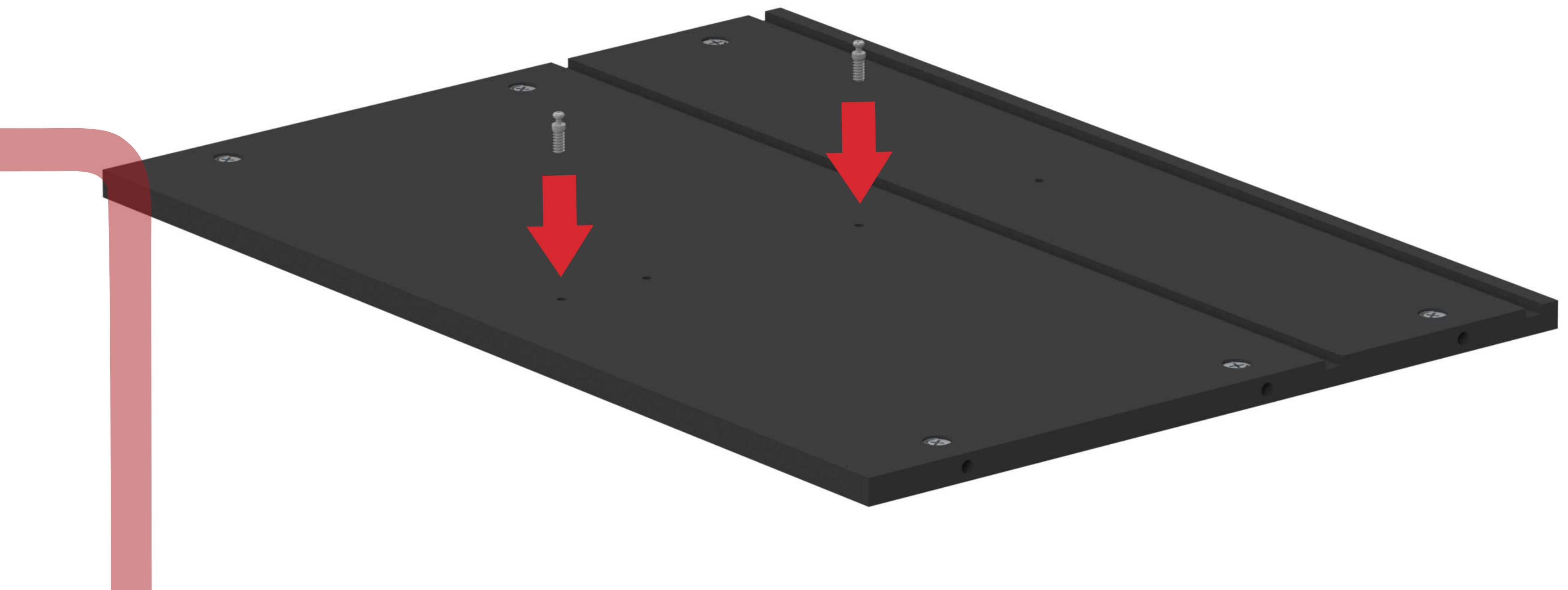

9579

01

Divisão Dir/Esq Arm

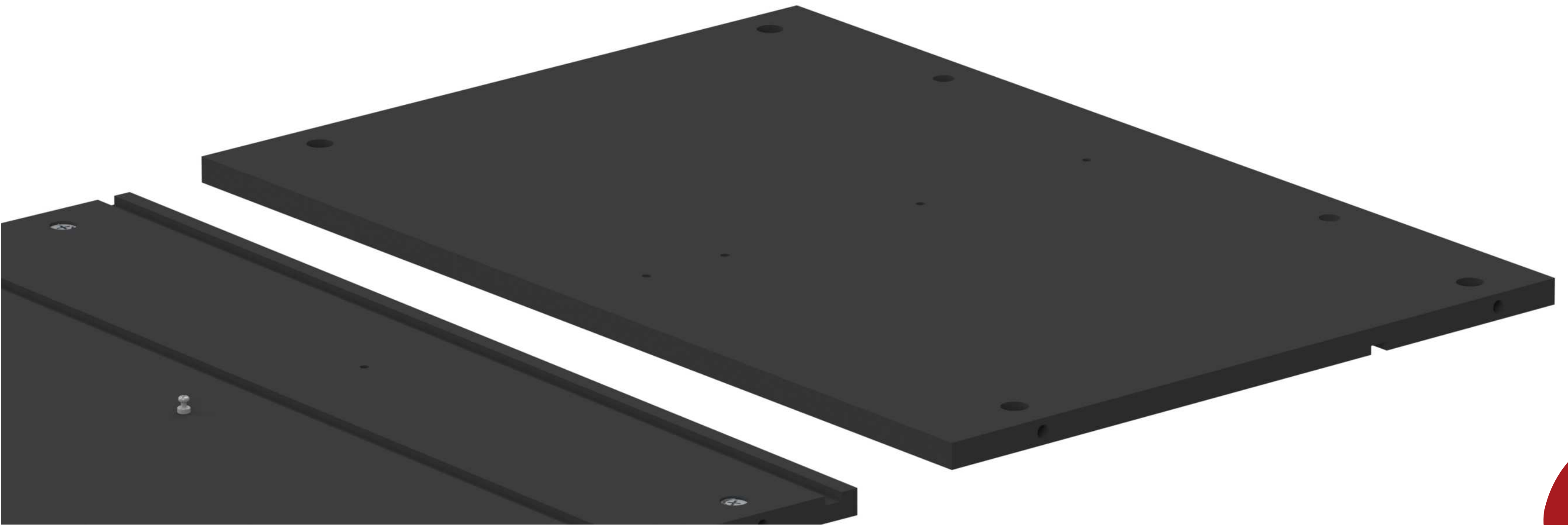

750
04



Tambor Girofix 15mm

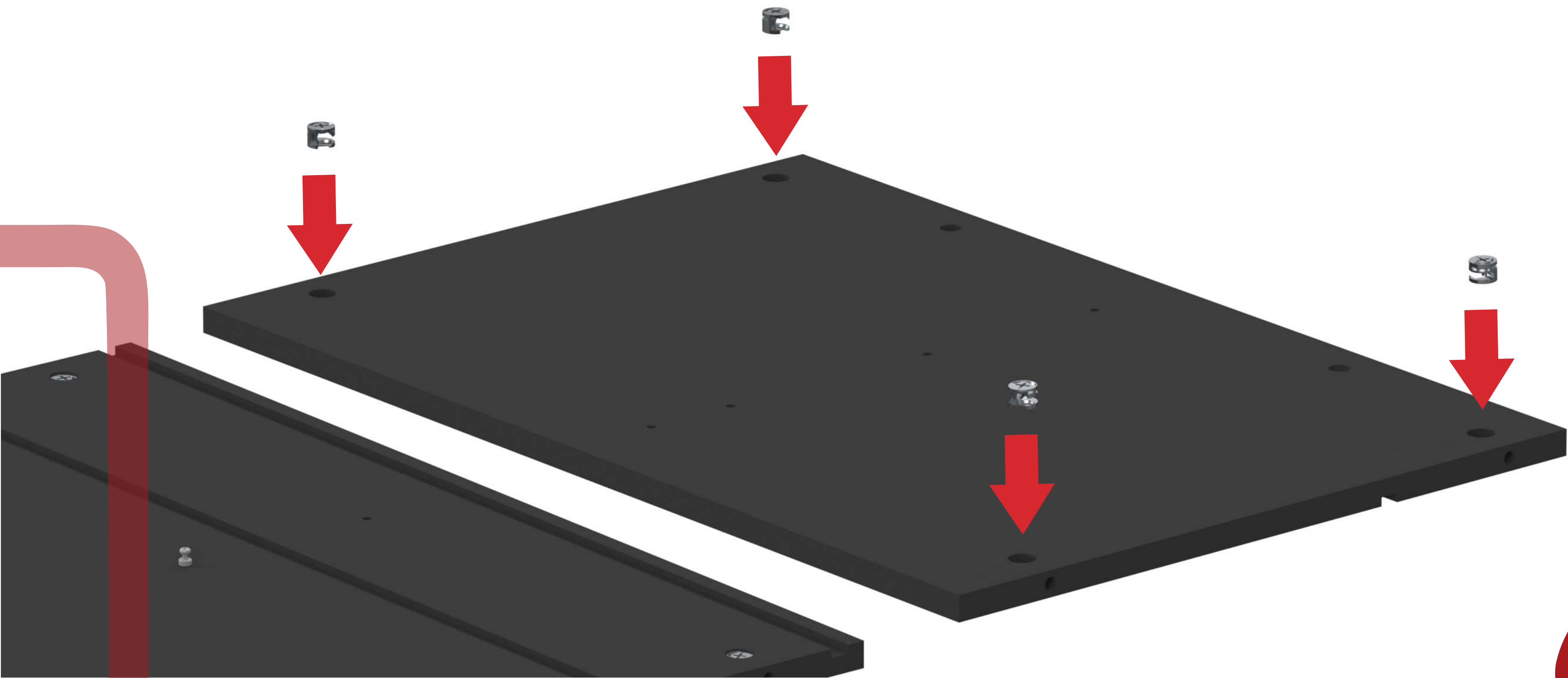

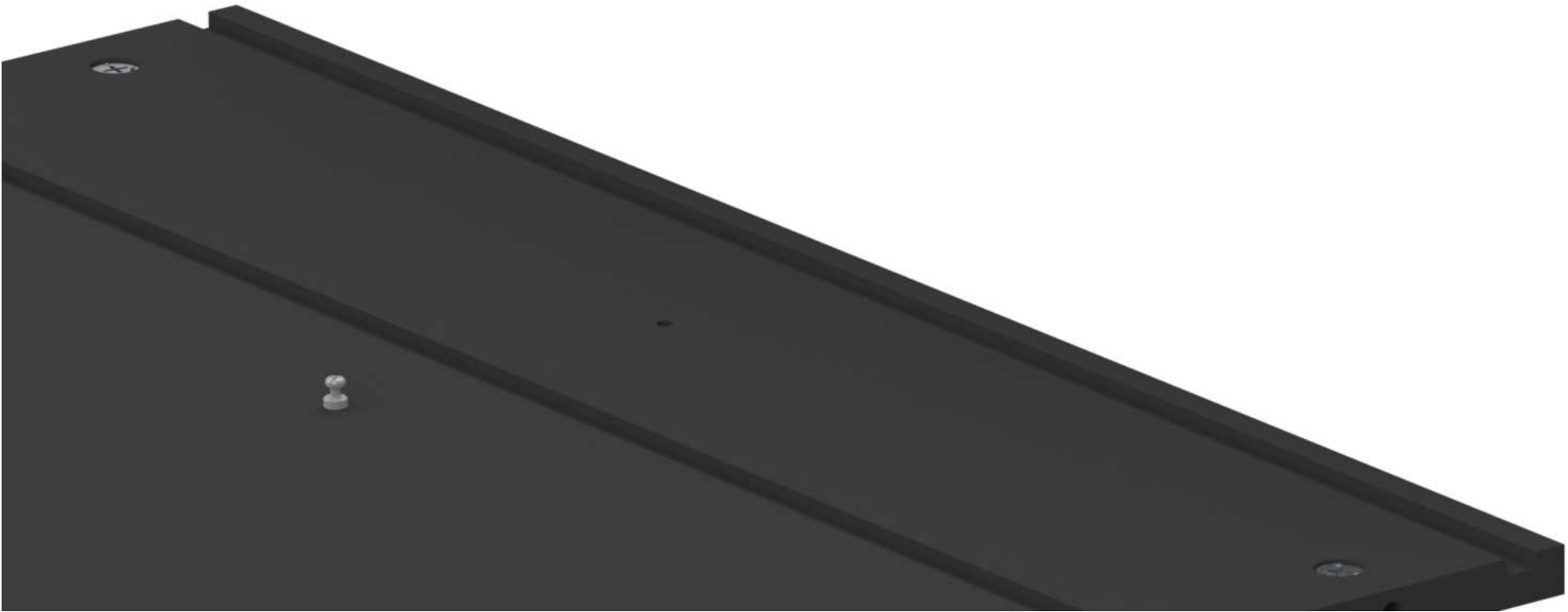
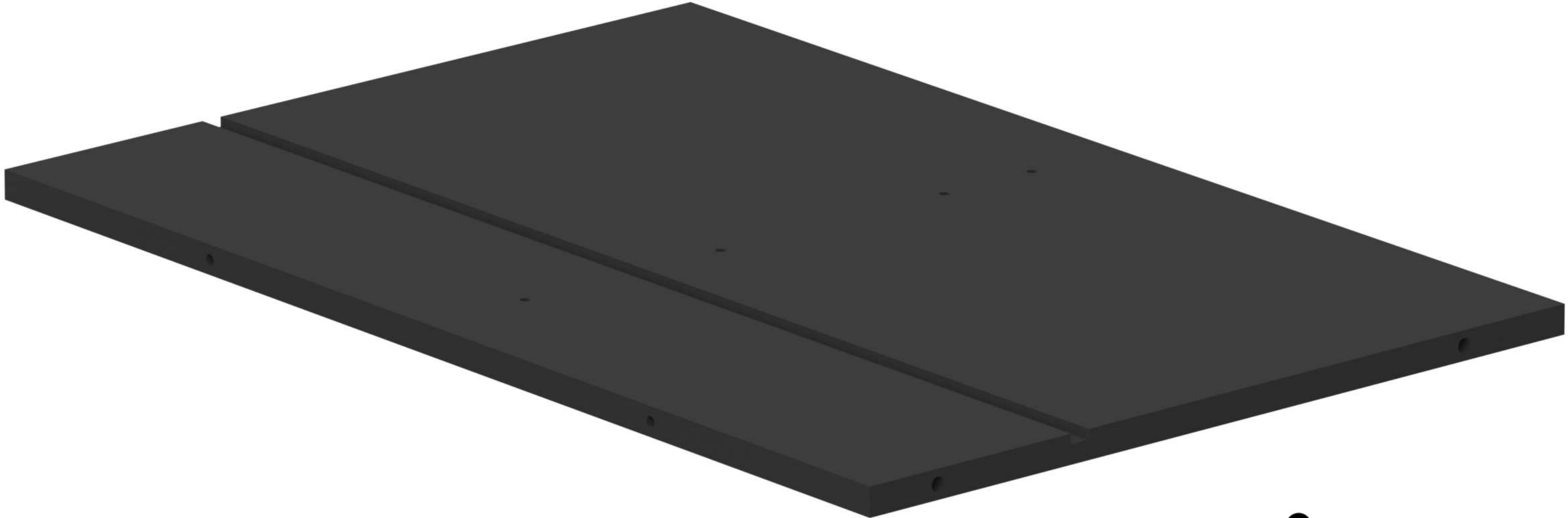

695

02

Pino Girofix VB Aa6

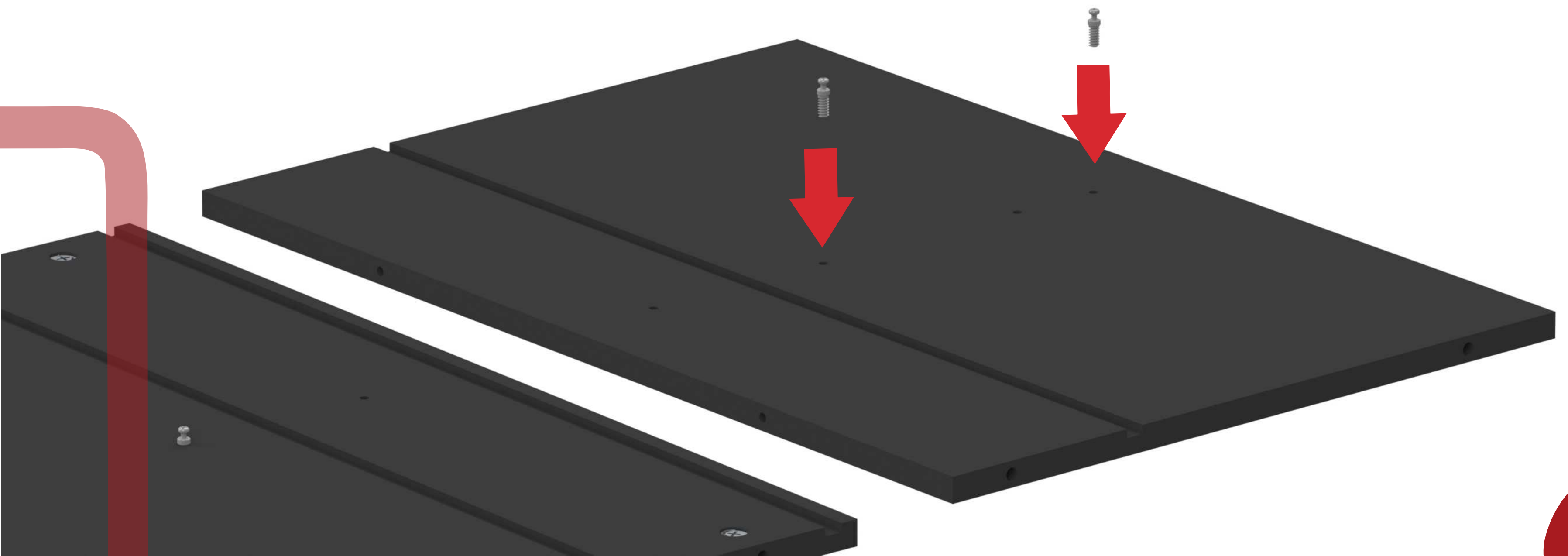

9579



01

Divisão Dir/Esq Arm

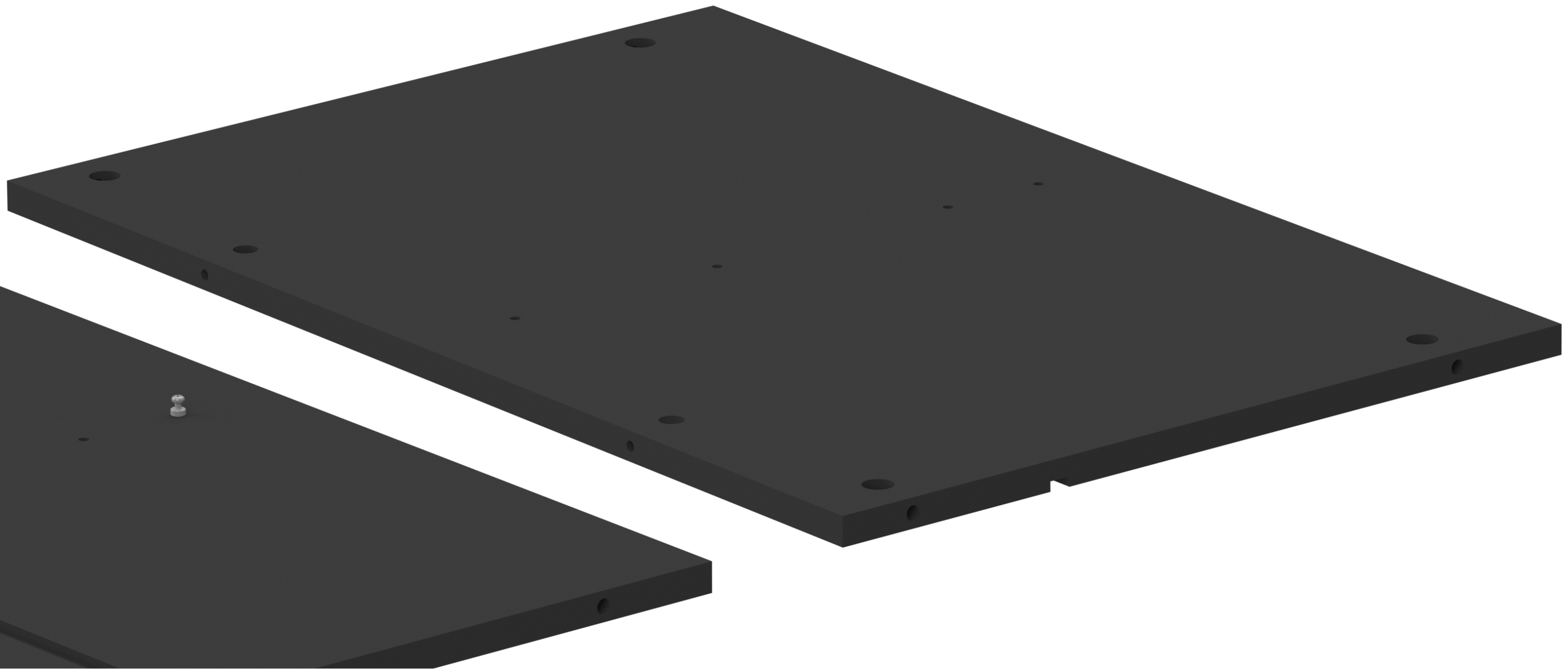

8965

02

Porca 12x60x0,18

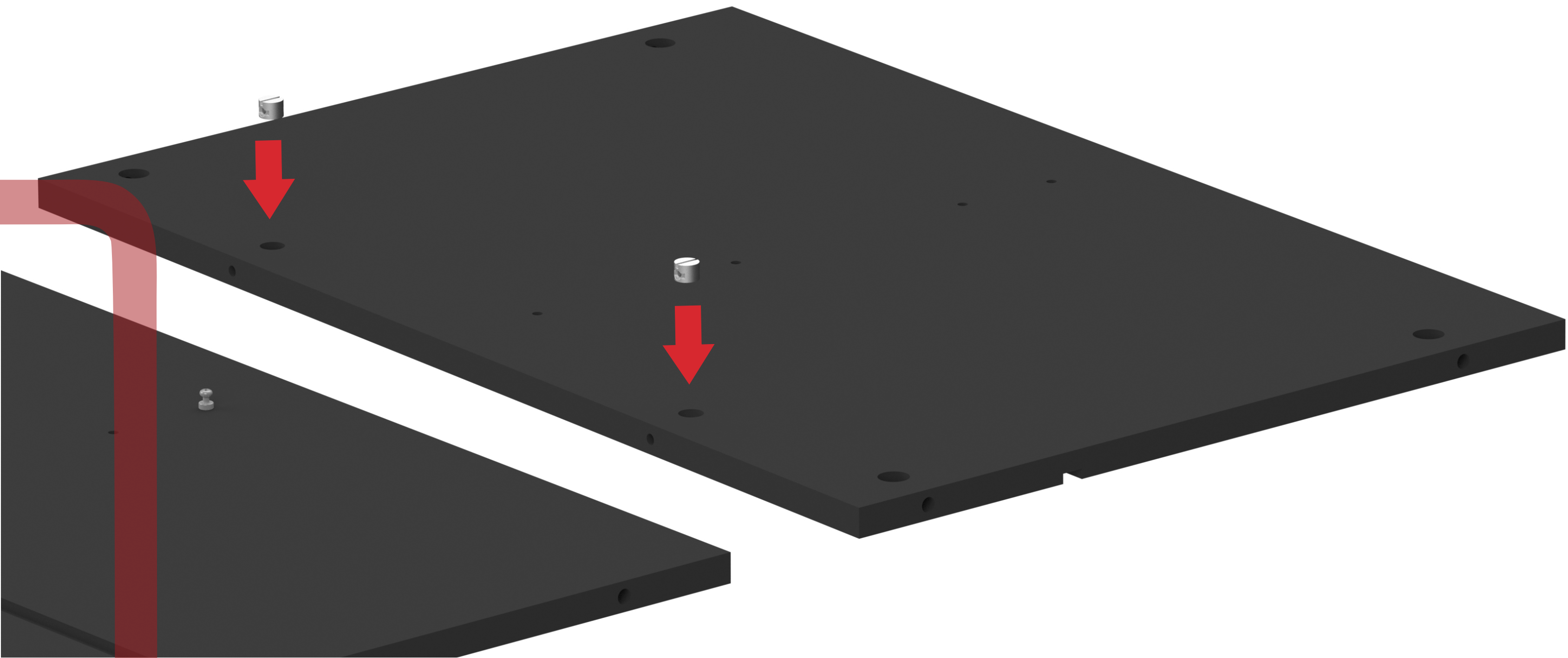

750

20

Tambor Girofix 15mm

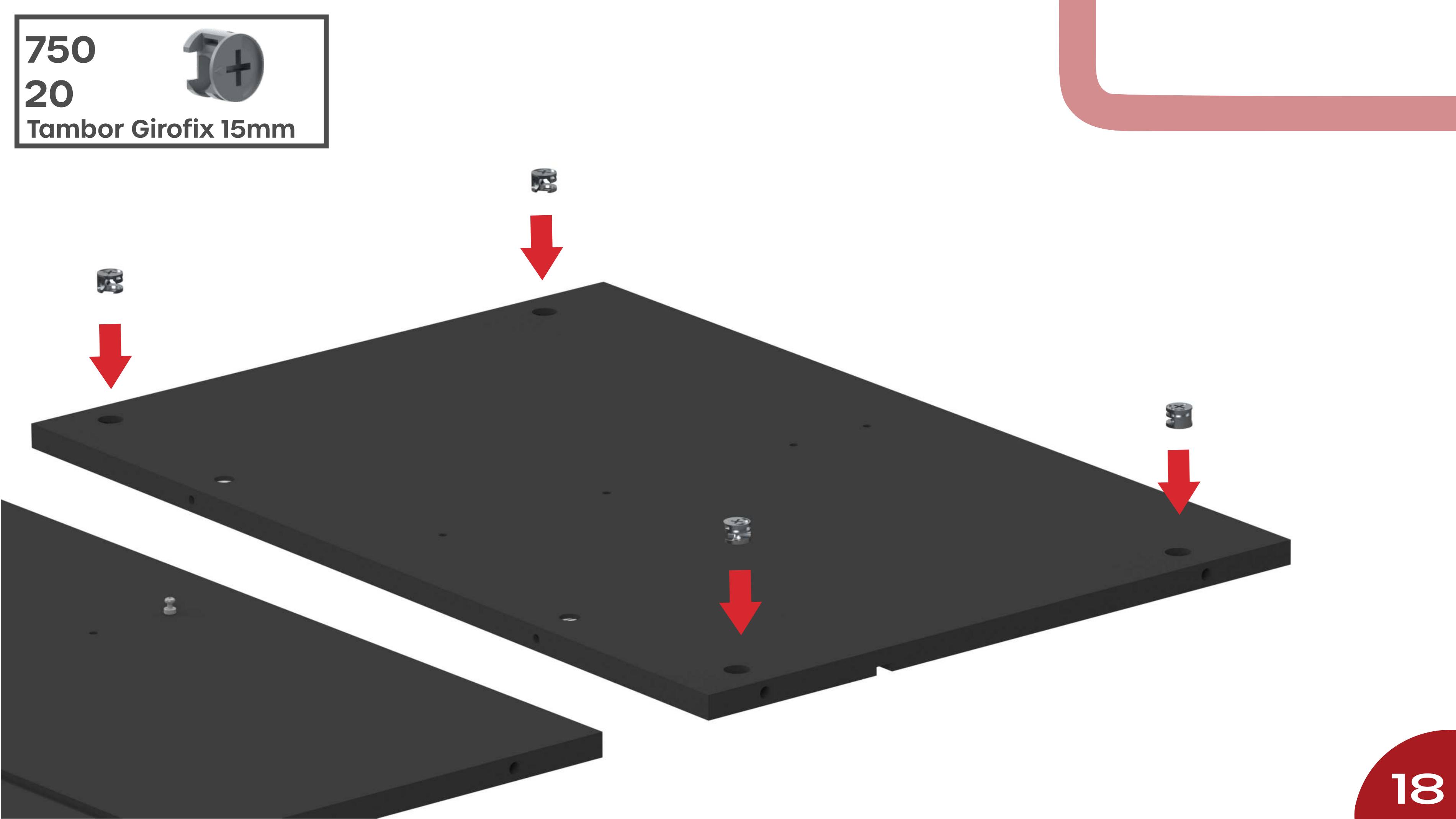

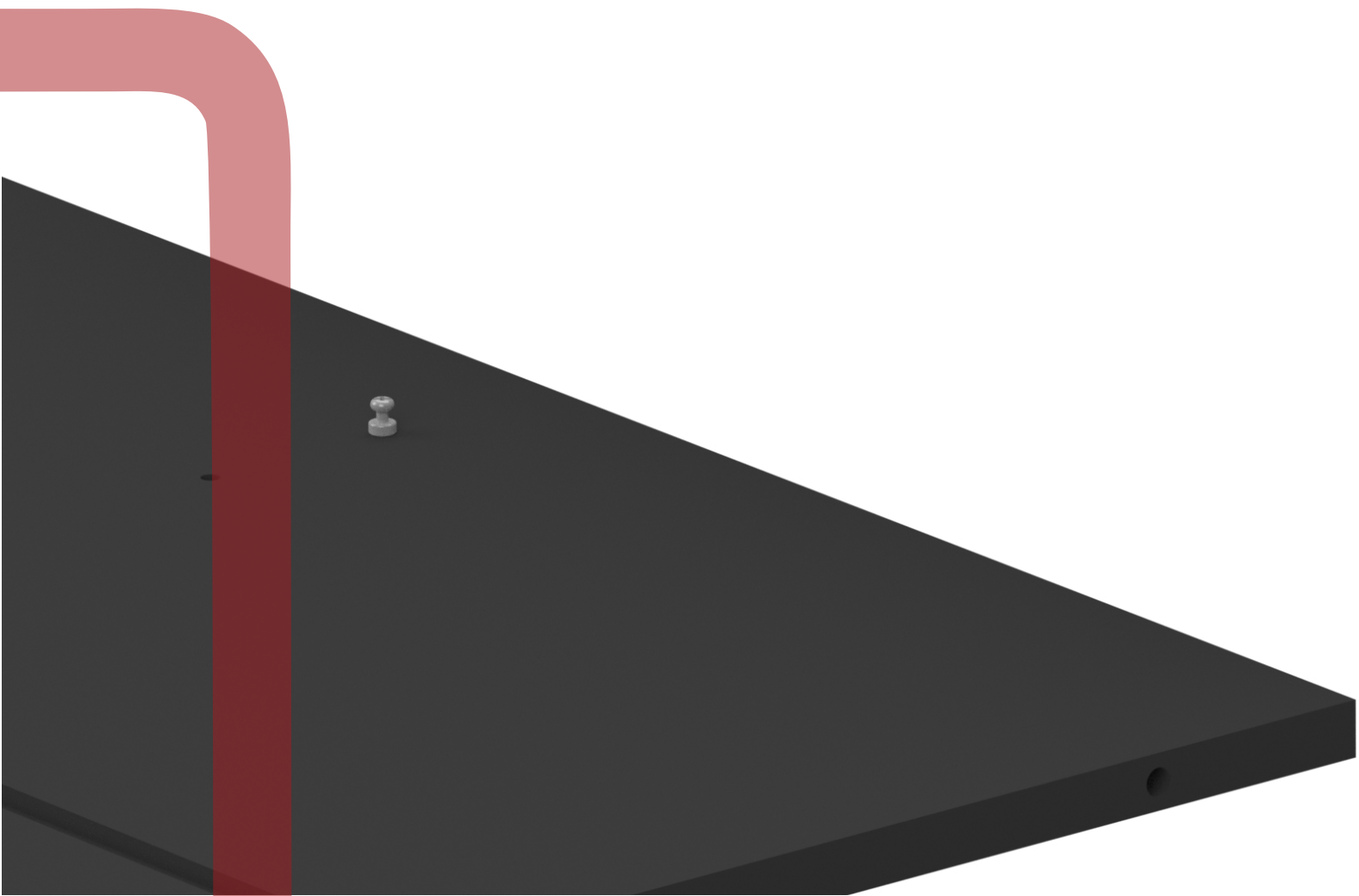
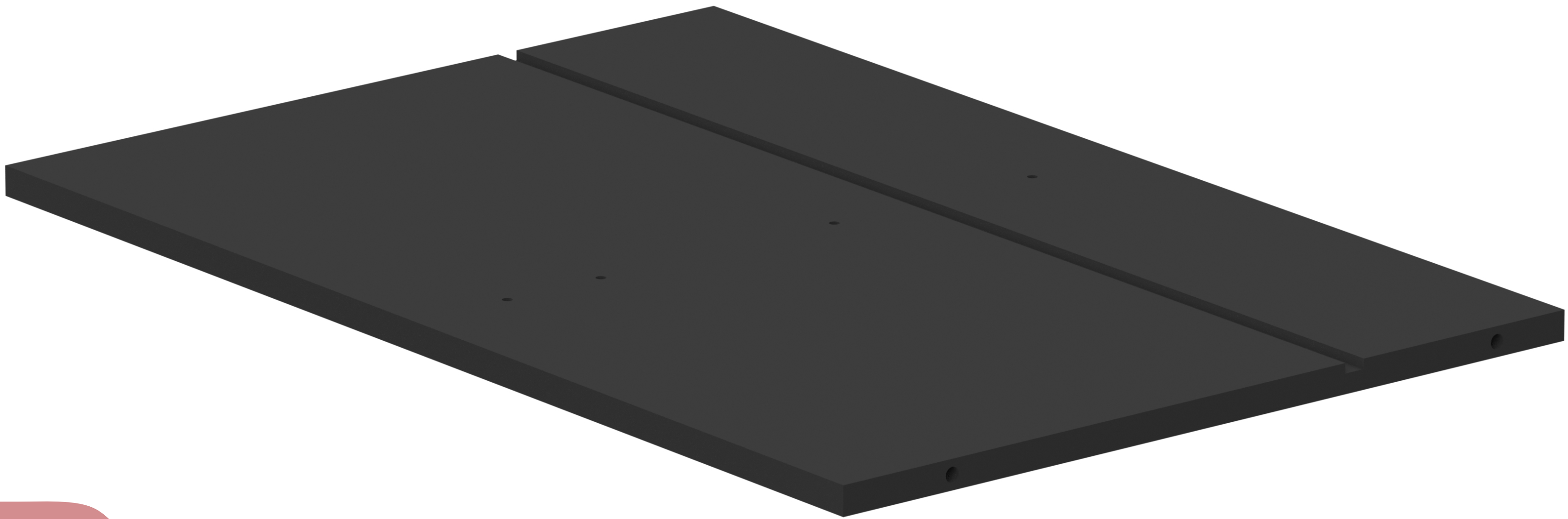

695

02

Pino Girofix VB Aa6

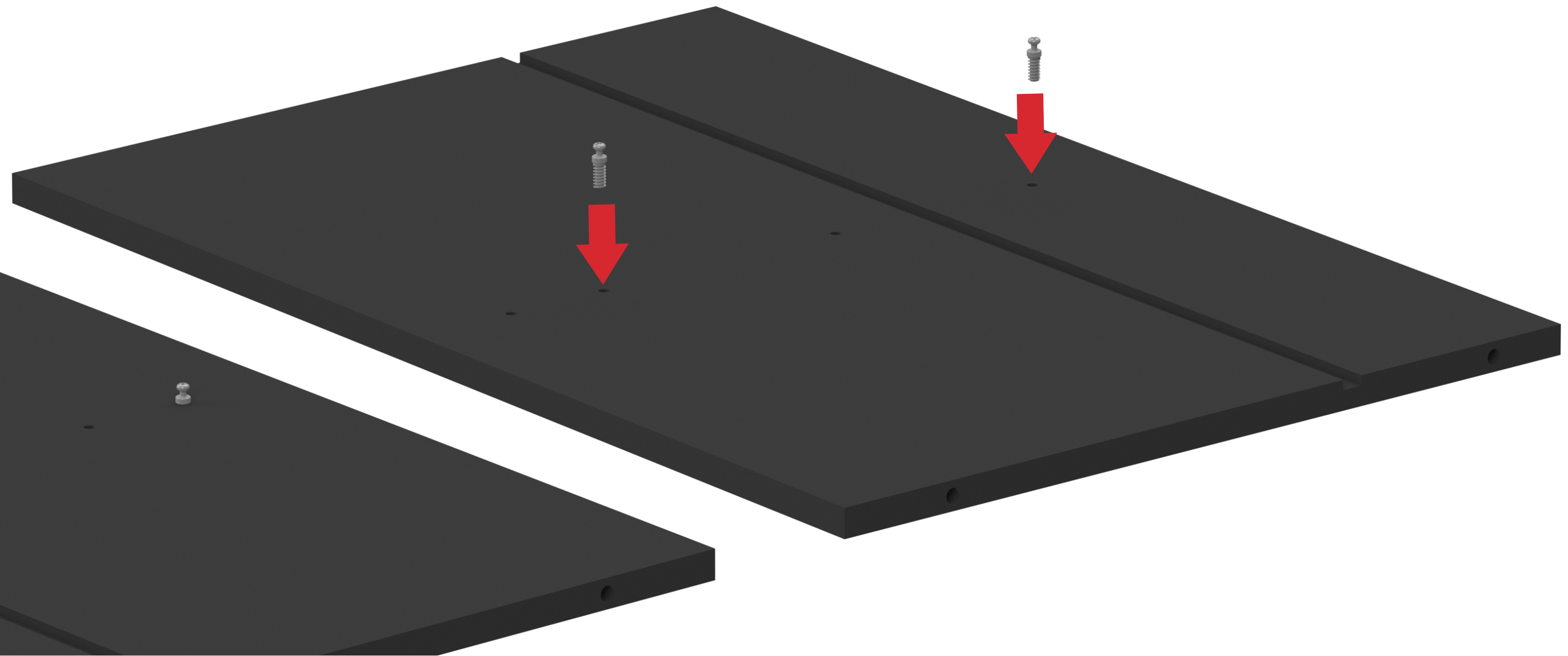

9577

01

Lateral Dir/Esq Arm

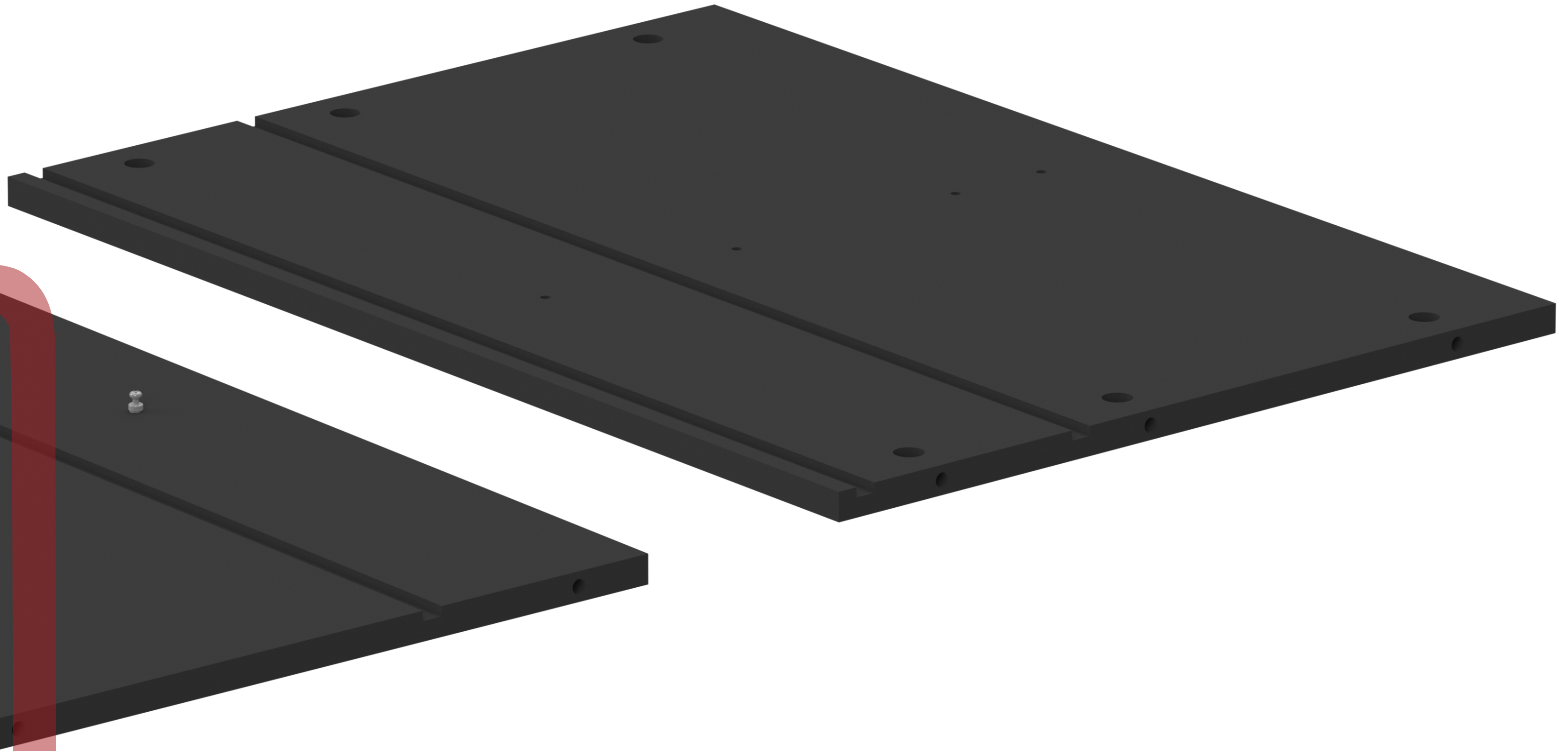

750
06



Tambor Girofix 15mm

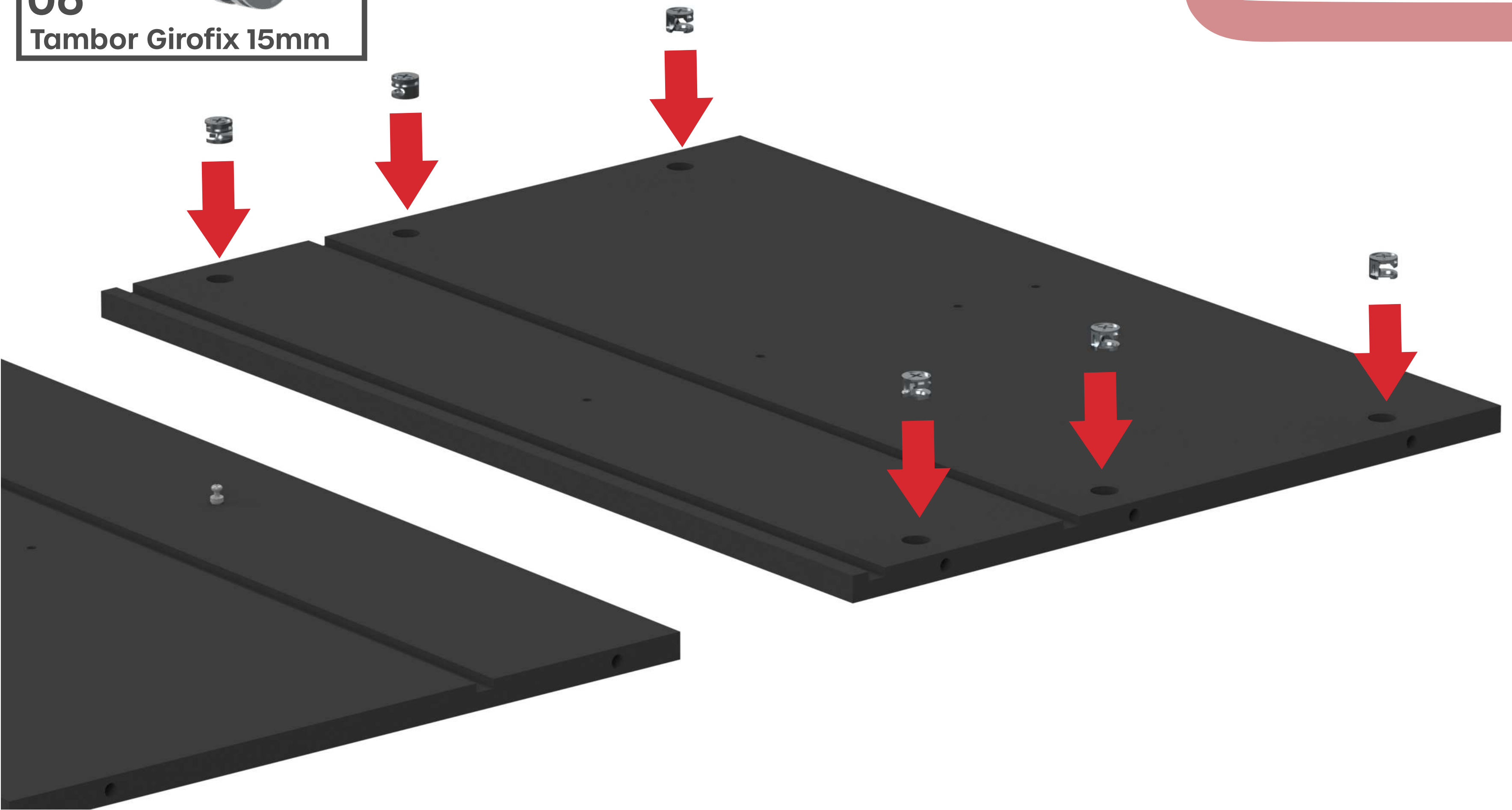

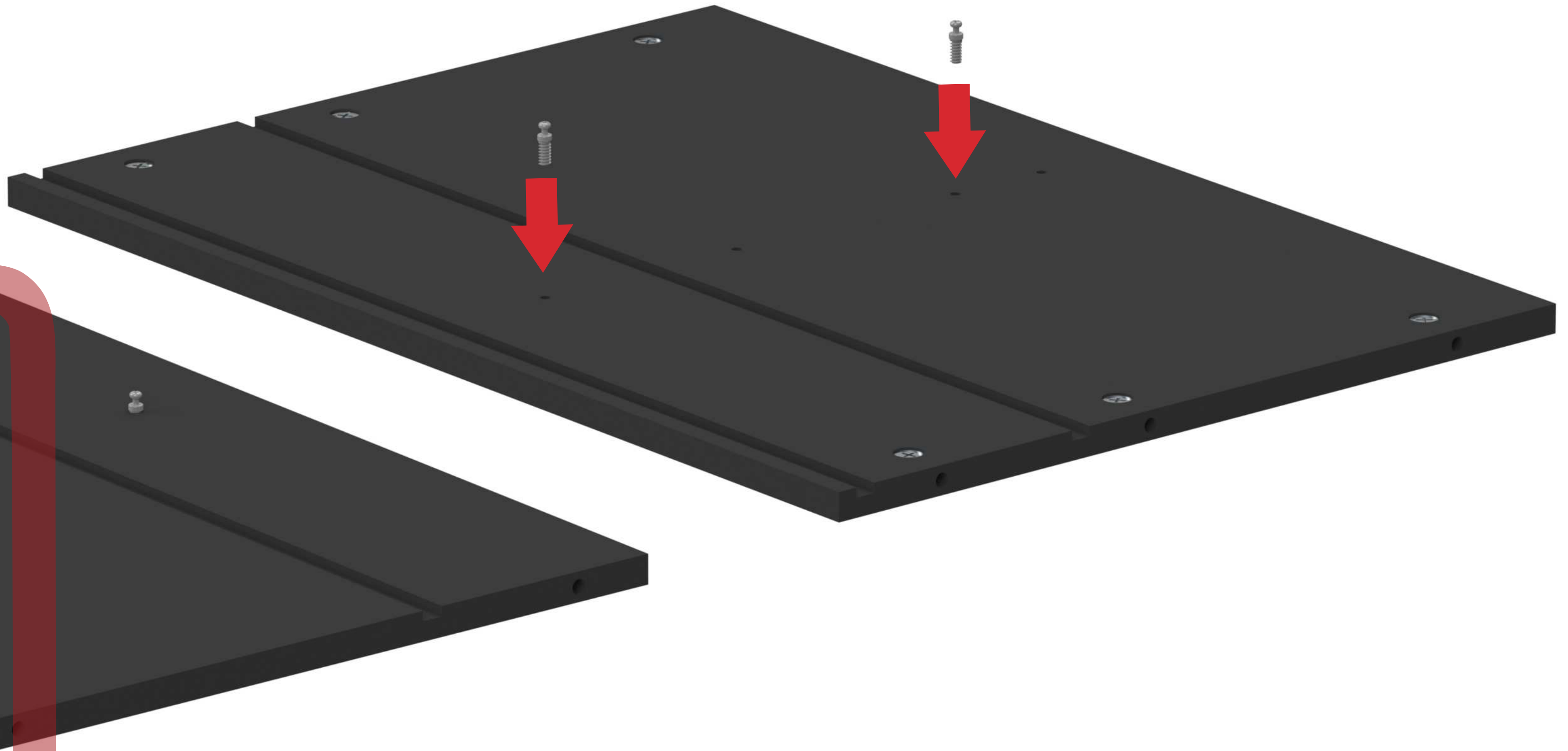



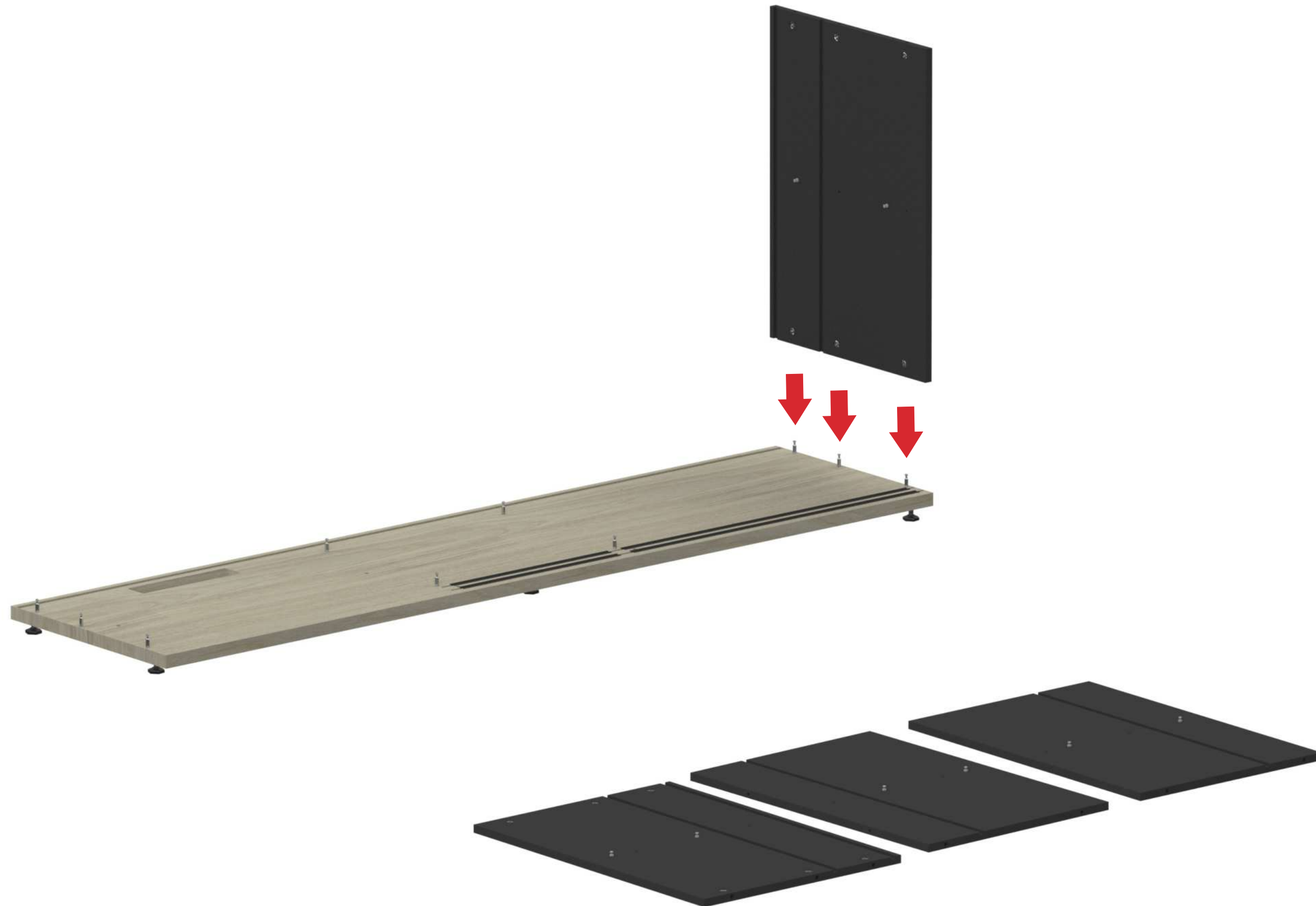

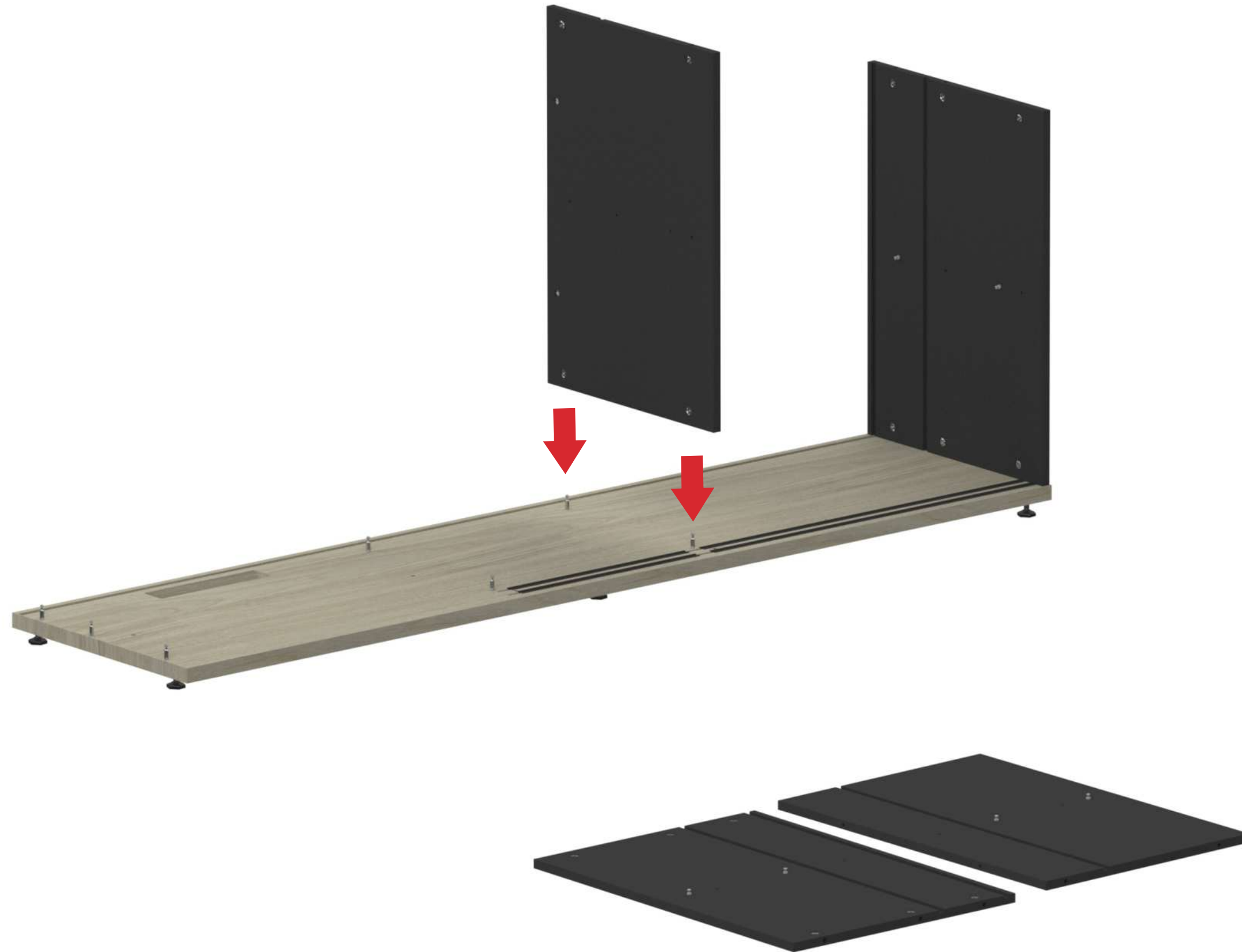

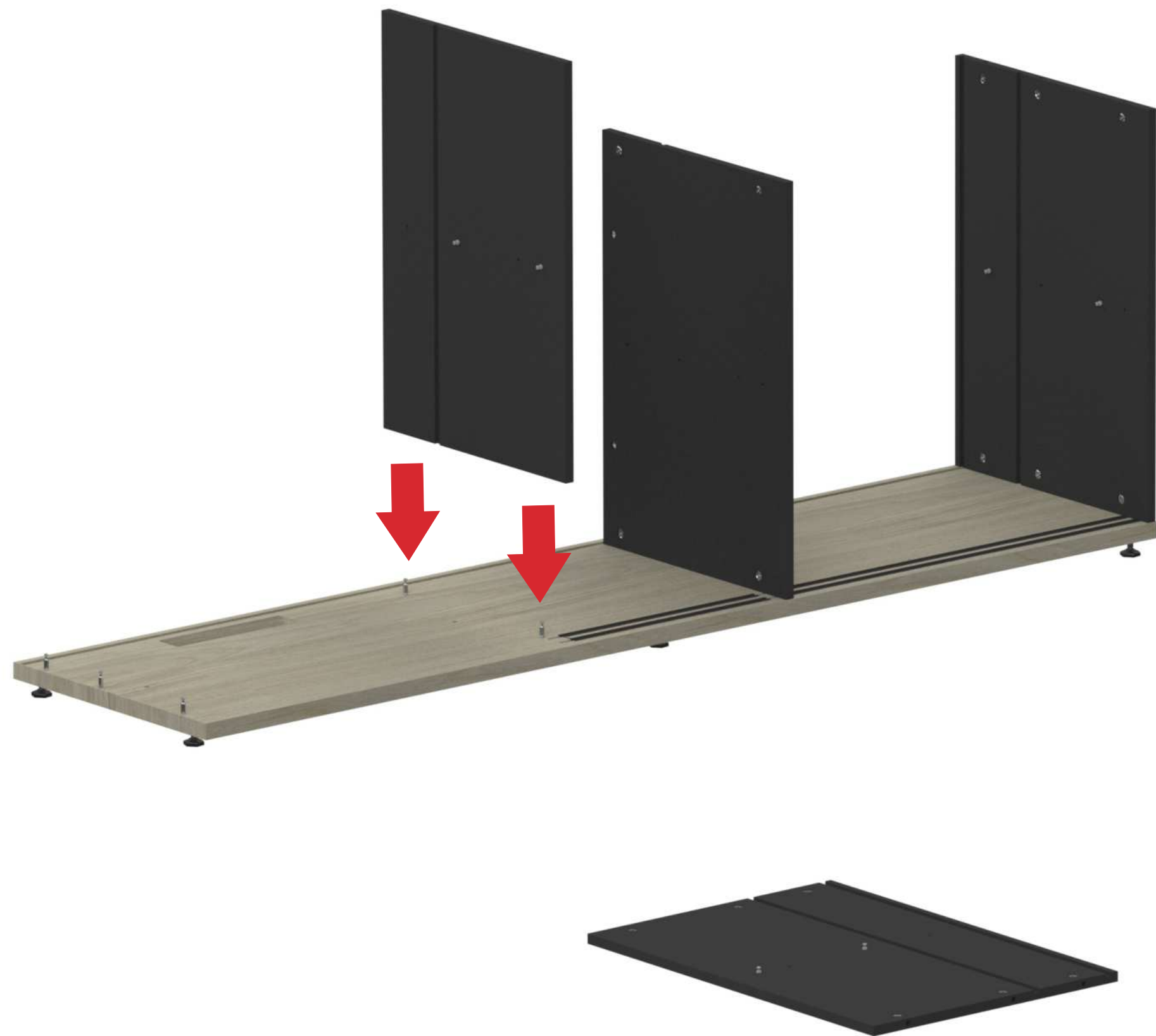



9594

01

Retaguarda Maior

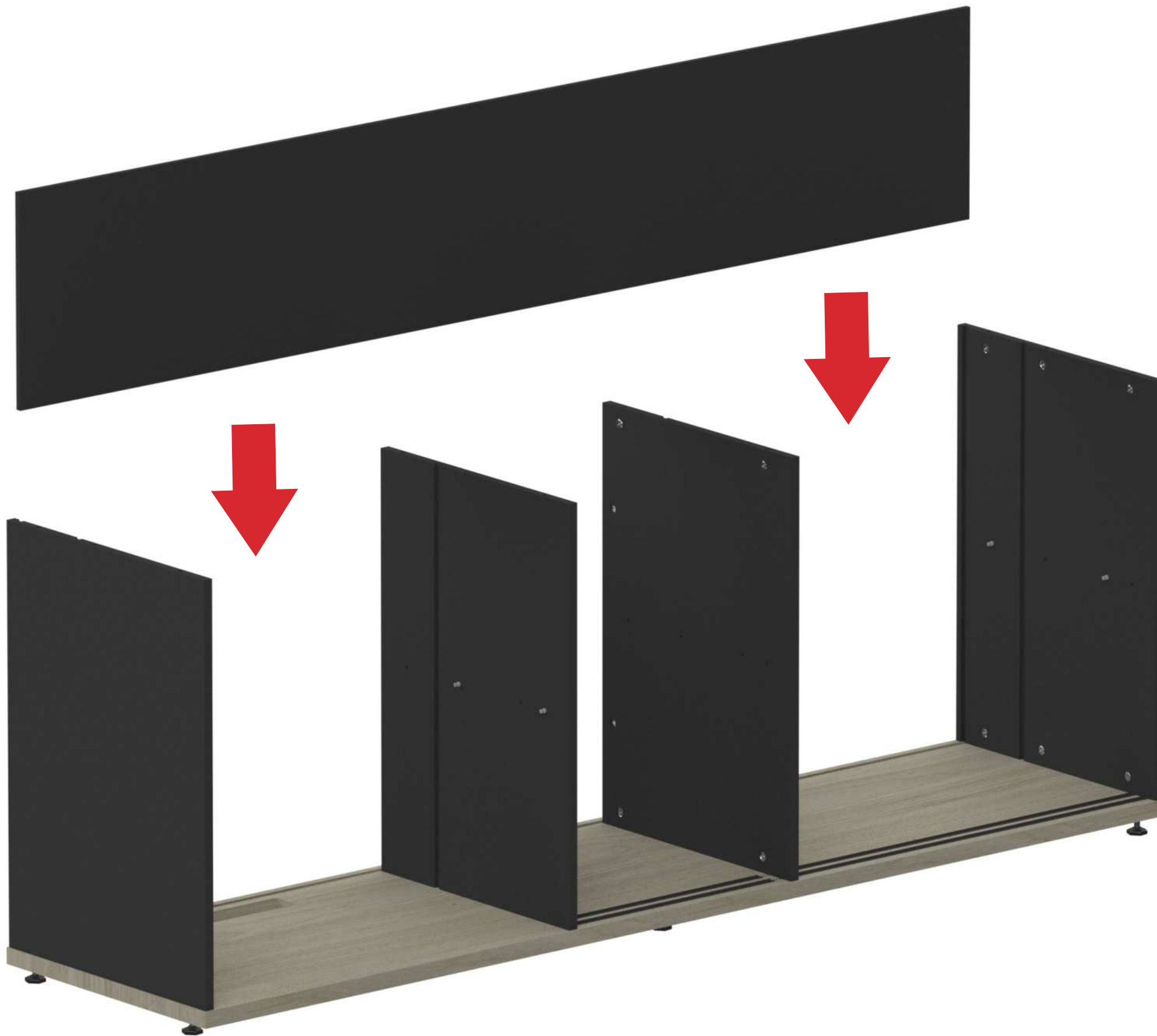

9619

01

Perfil PVC Viga H

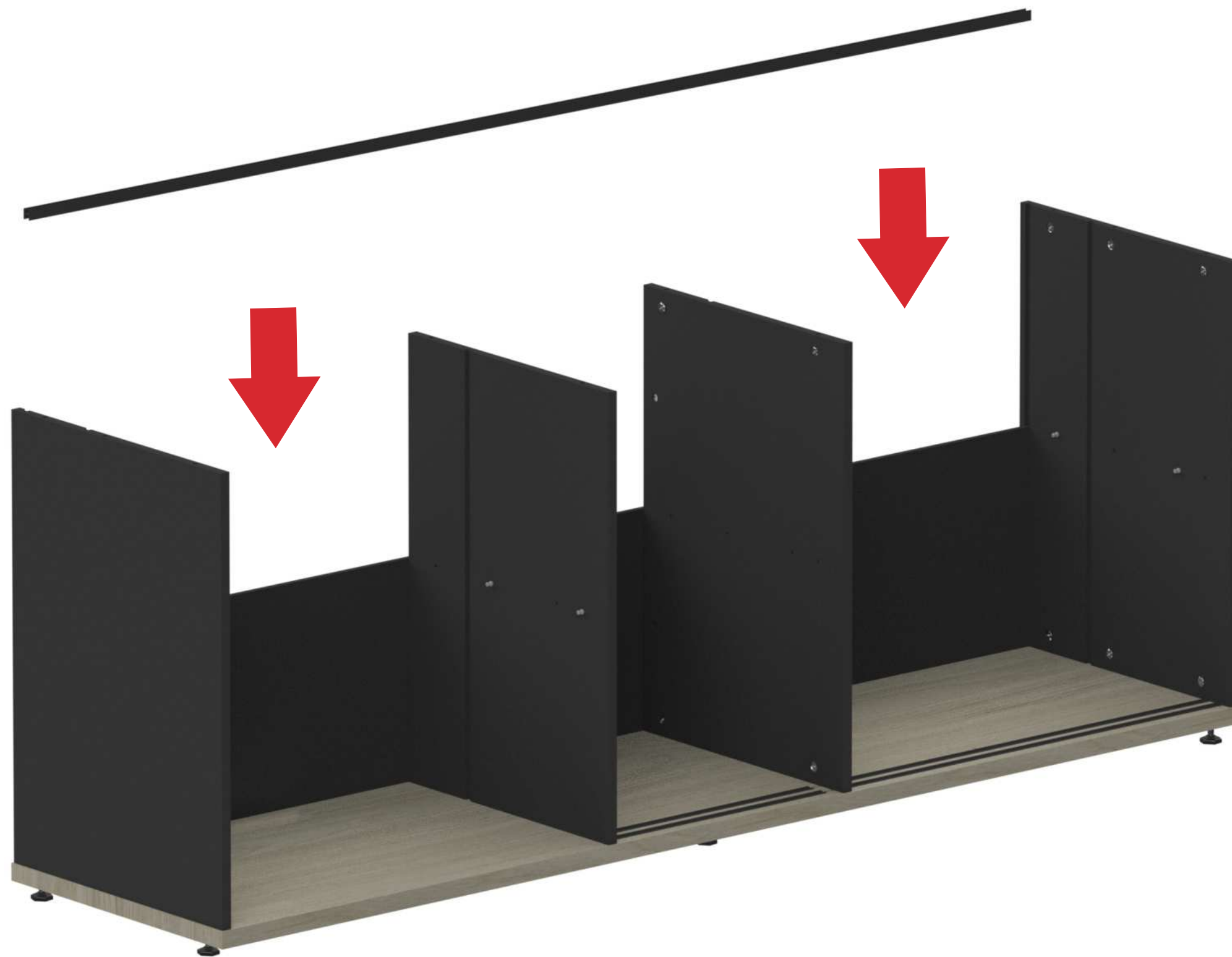

9594

01

Retaguarda Maior

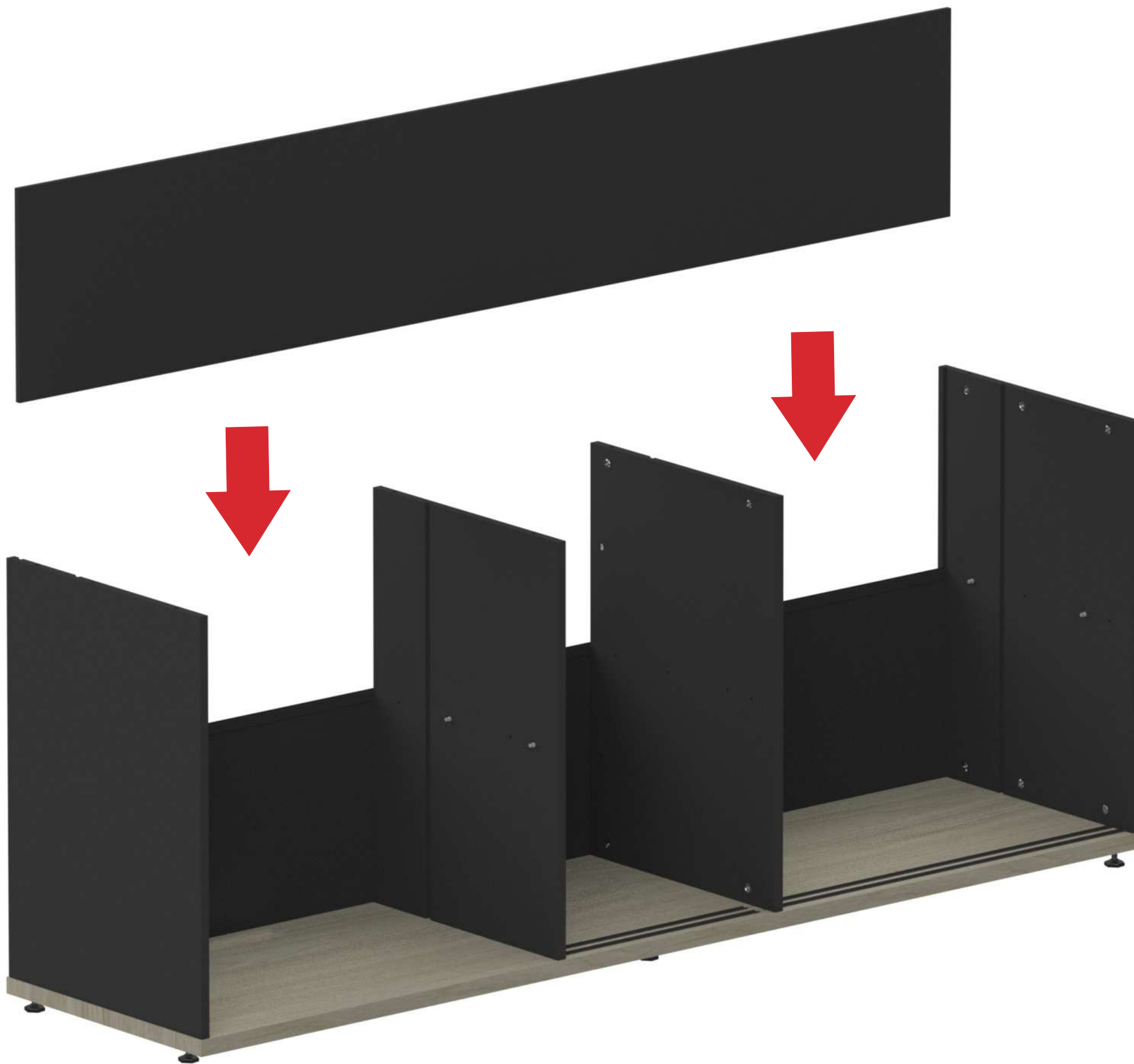

9598

01

Retaguarda Menor

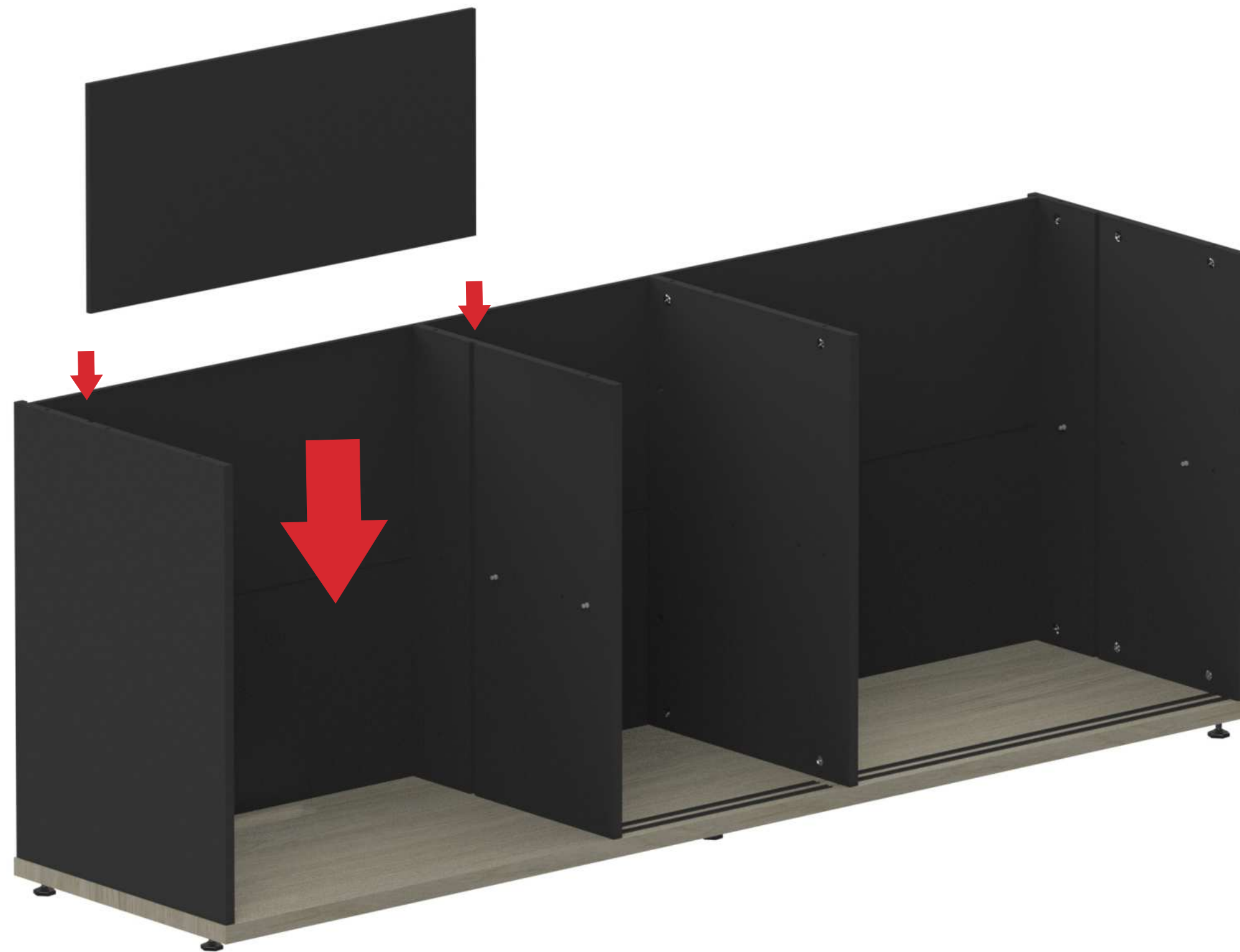

9598

01

Retaguarda Menor

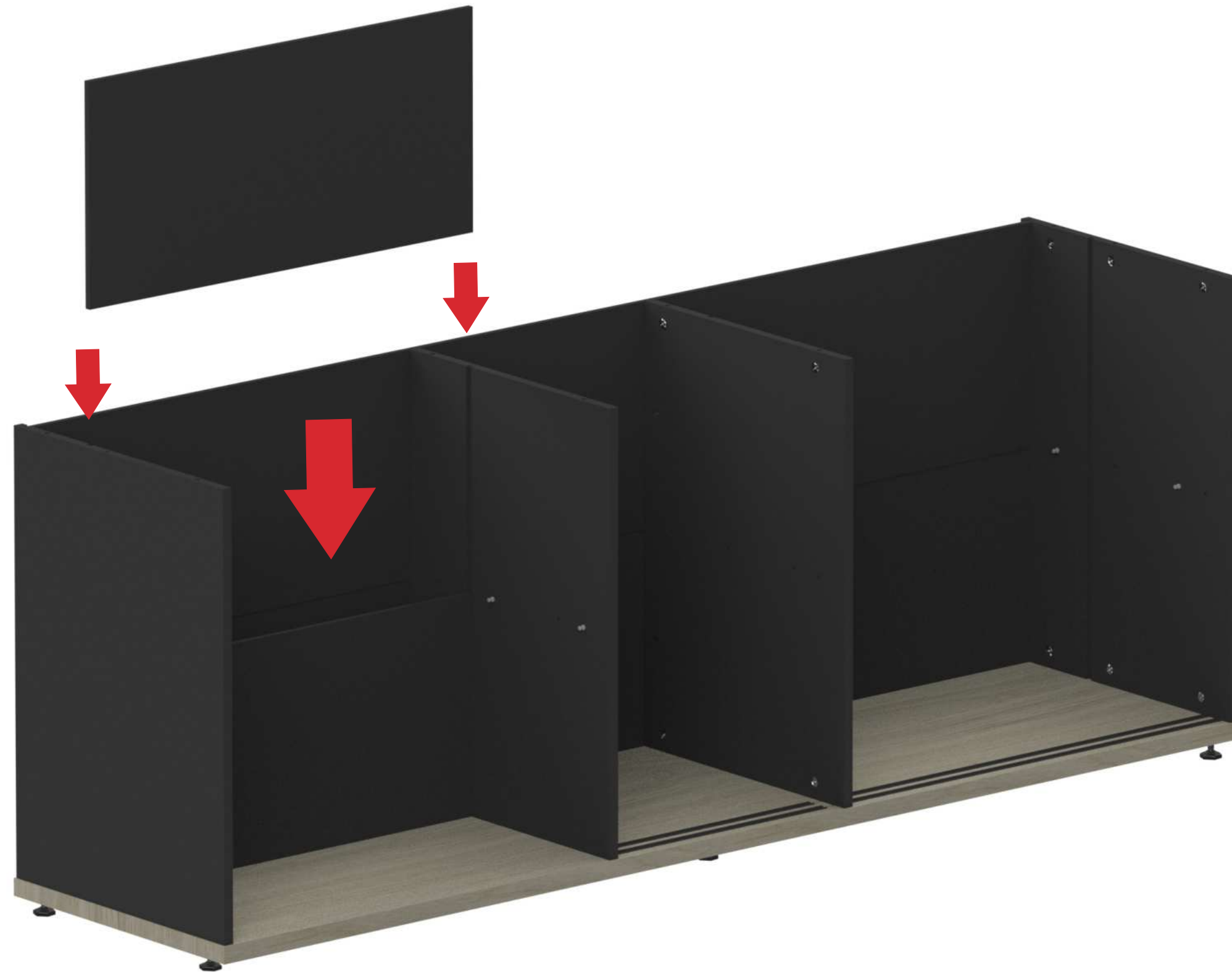

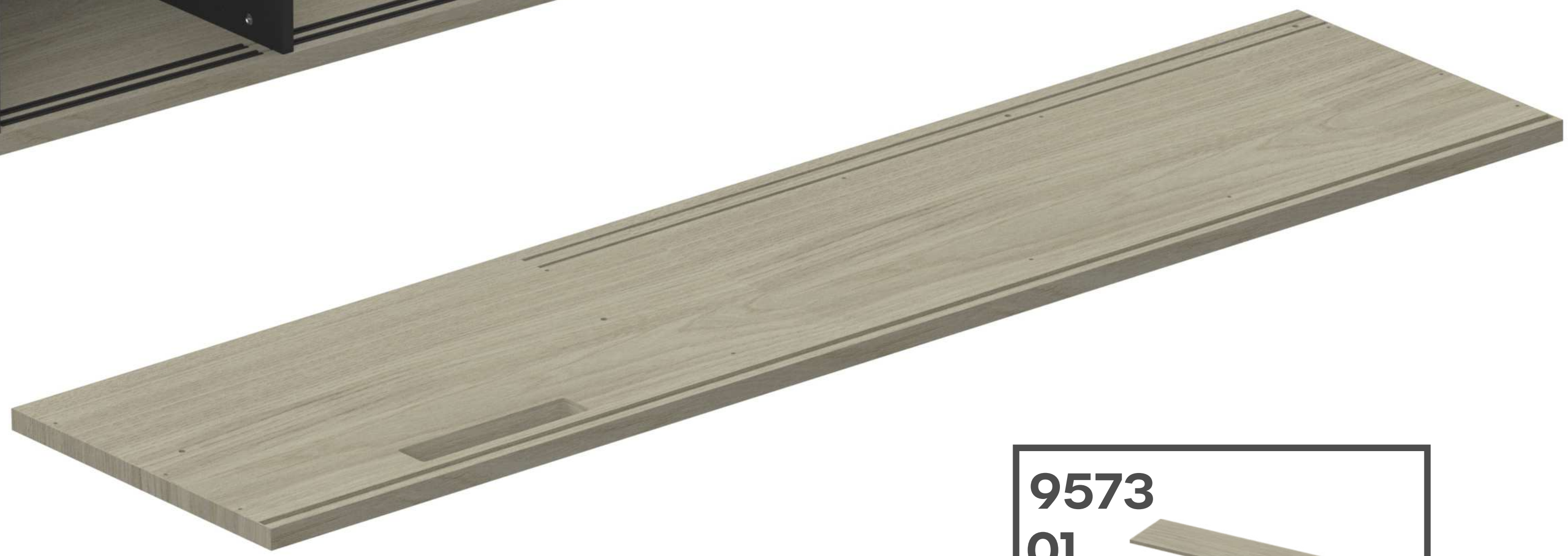

9573
01 
Tampo Balcão

9662
04
Perfil U

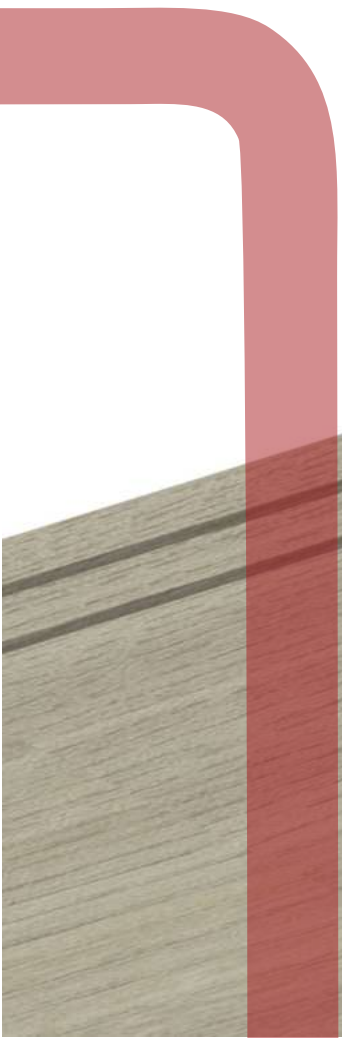

910

01

Suporte Plastico 8/10



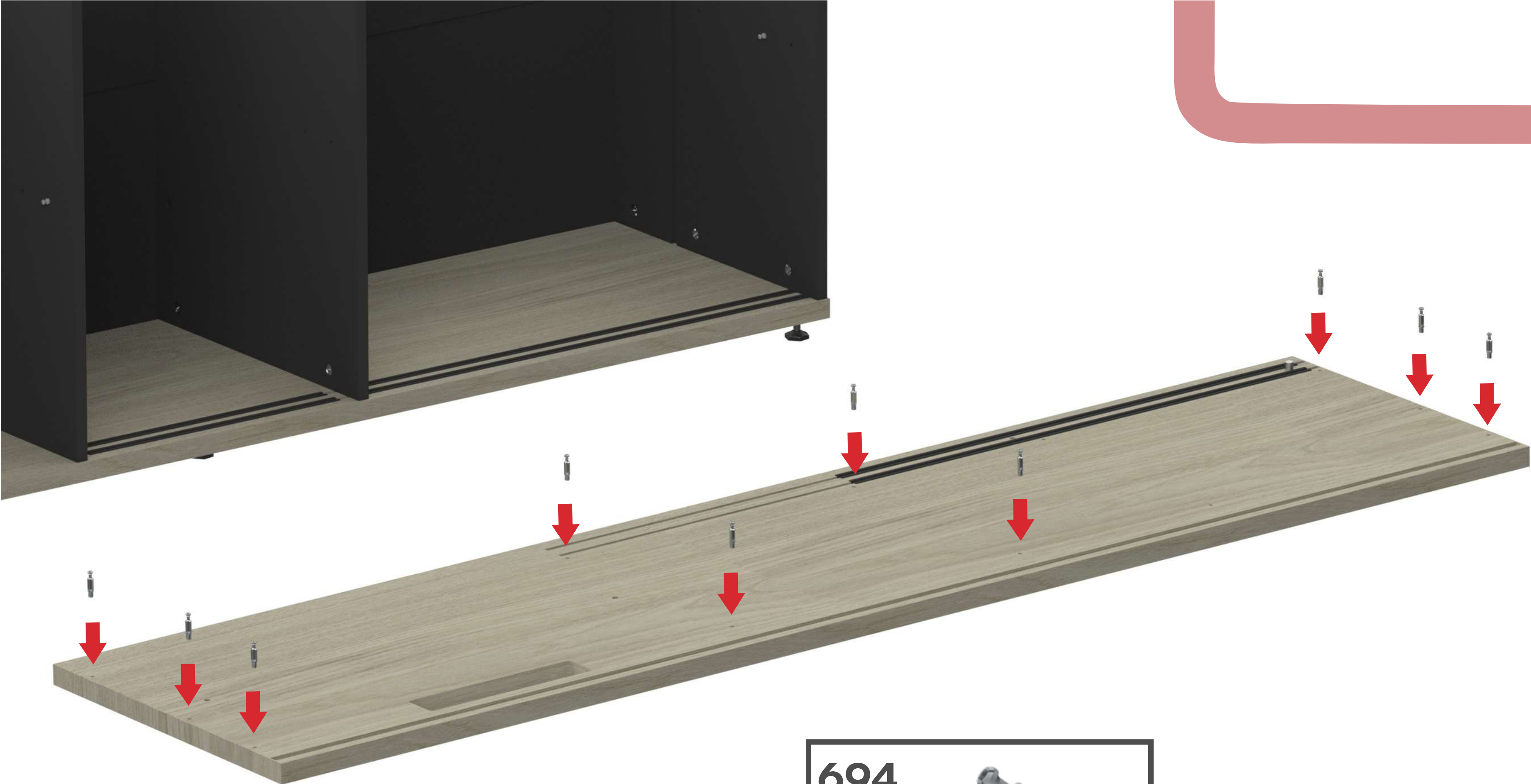

694
10
Pino Girofix 6mm







9581

01

Lateral Direito Gav



9604

01

Tranca Galvalume

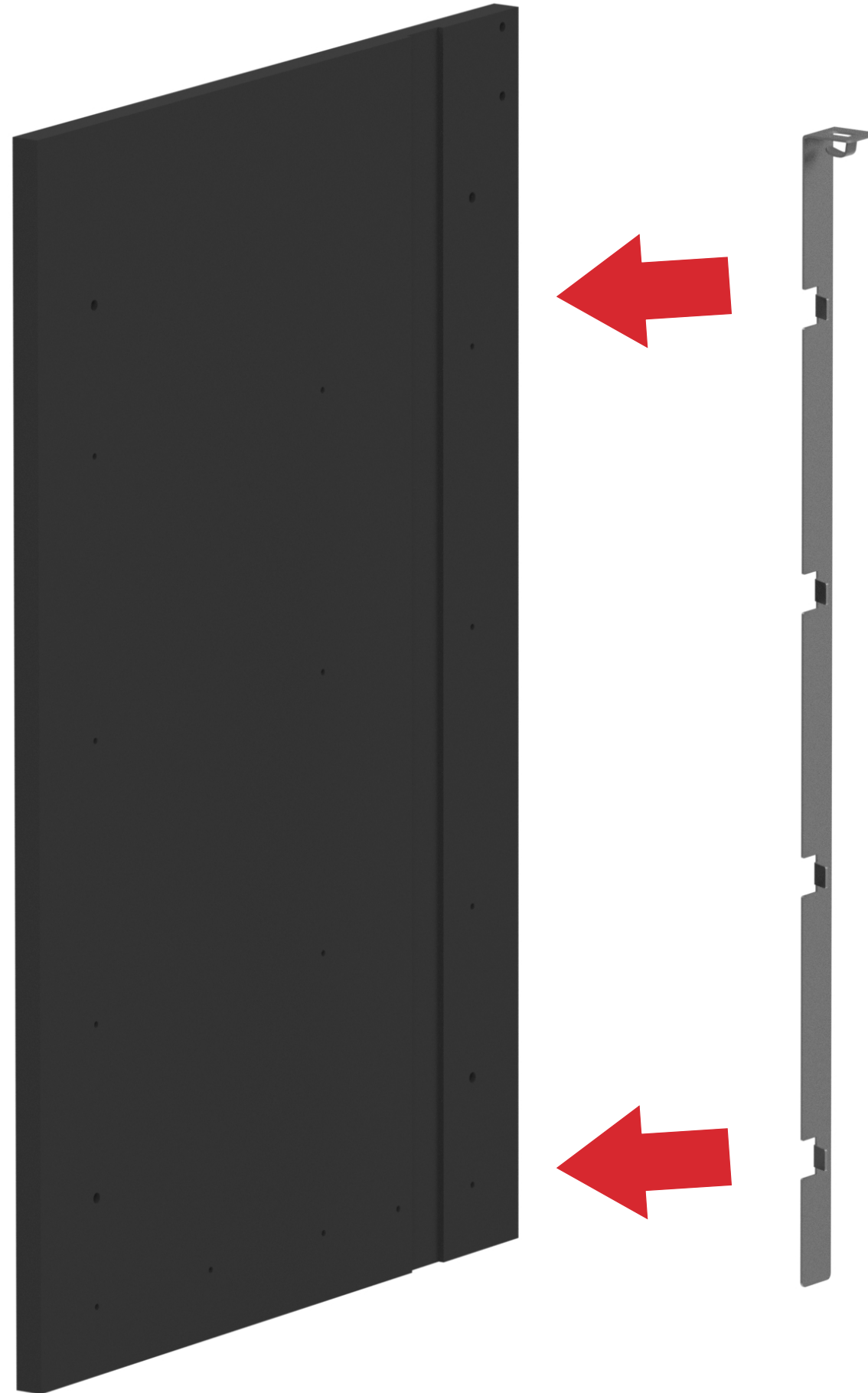

594

02

Trilho Corrediça Par

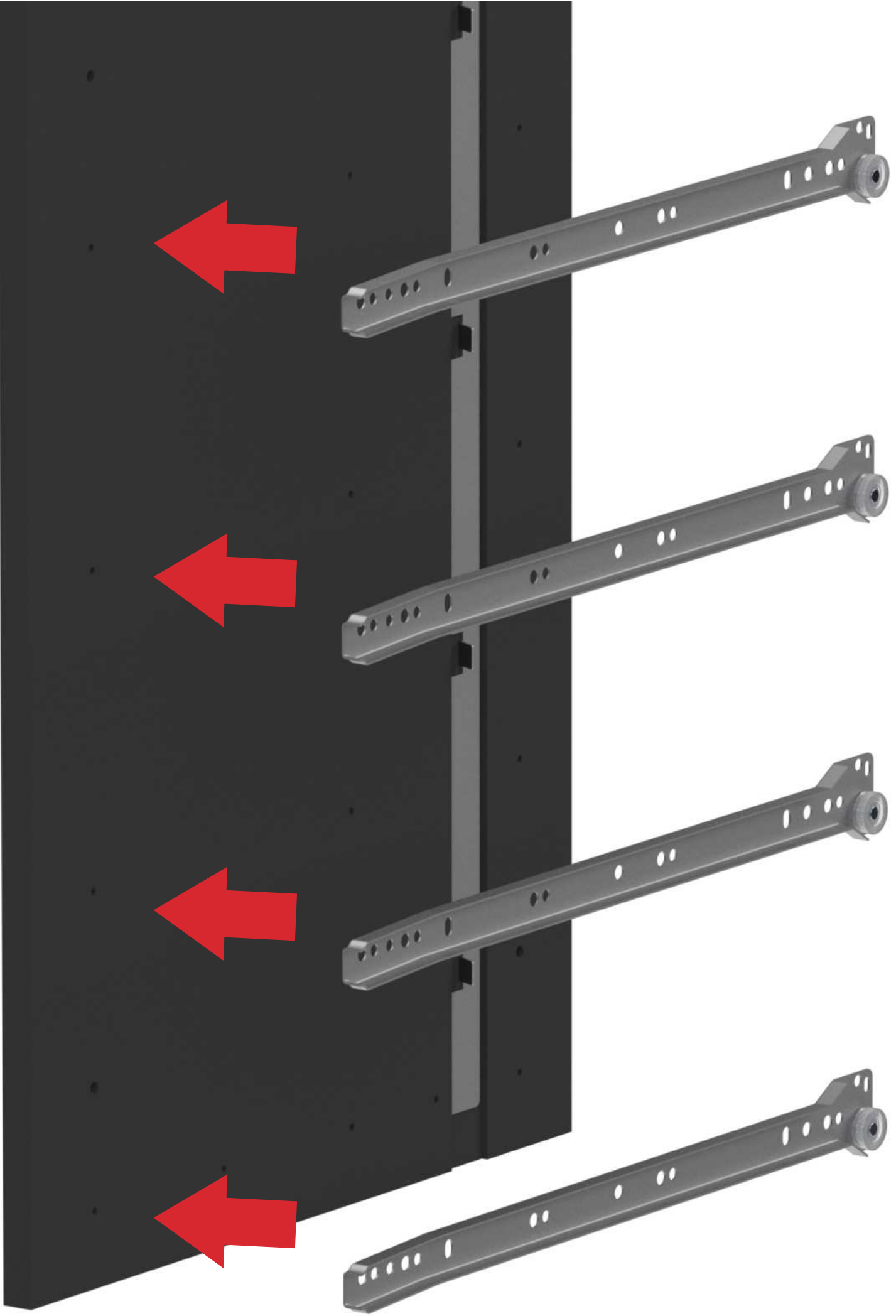
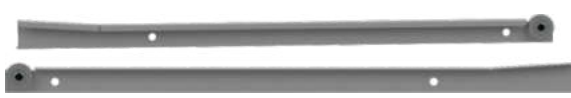

825

12

Parafuso 4x14mm

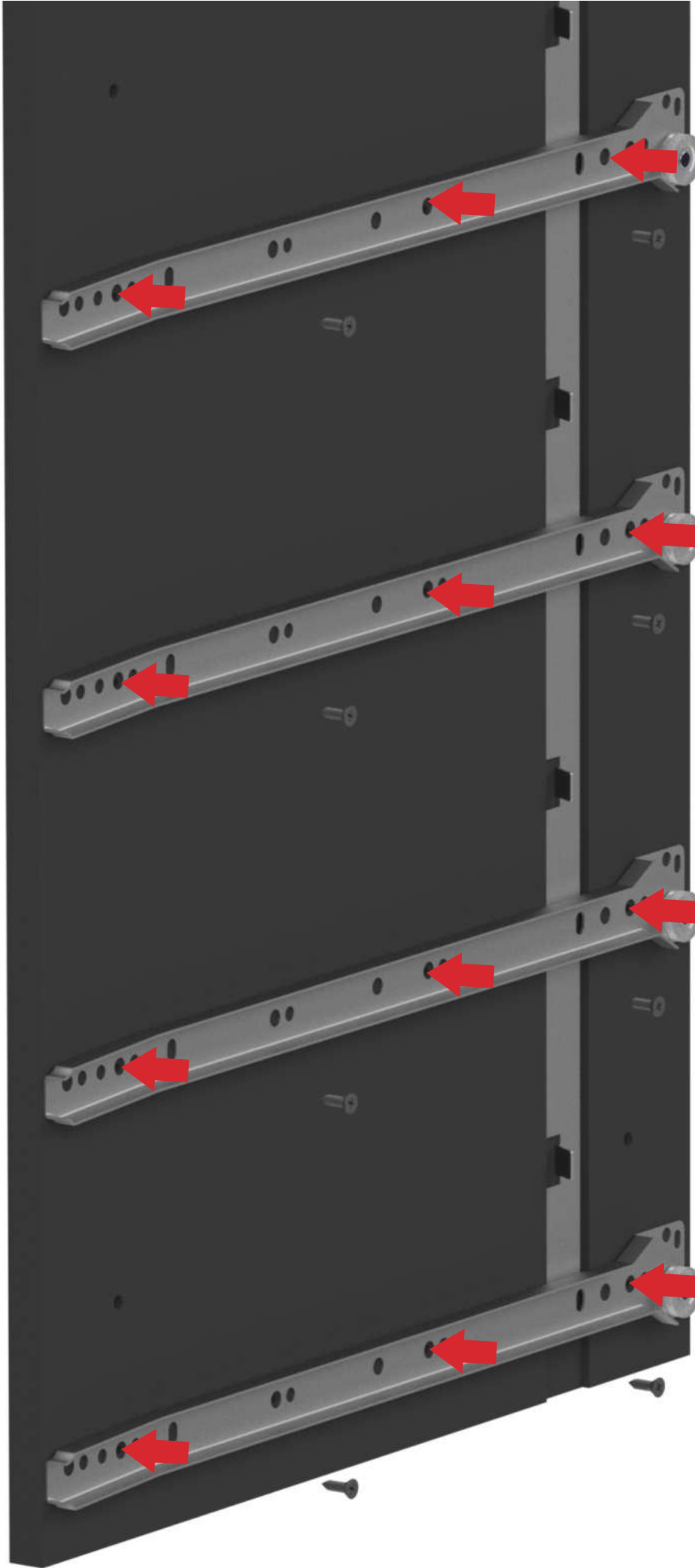

9583

01

Lateral Esquerda Gav

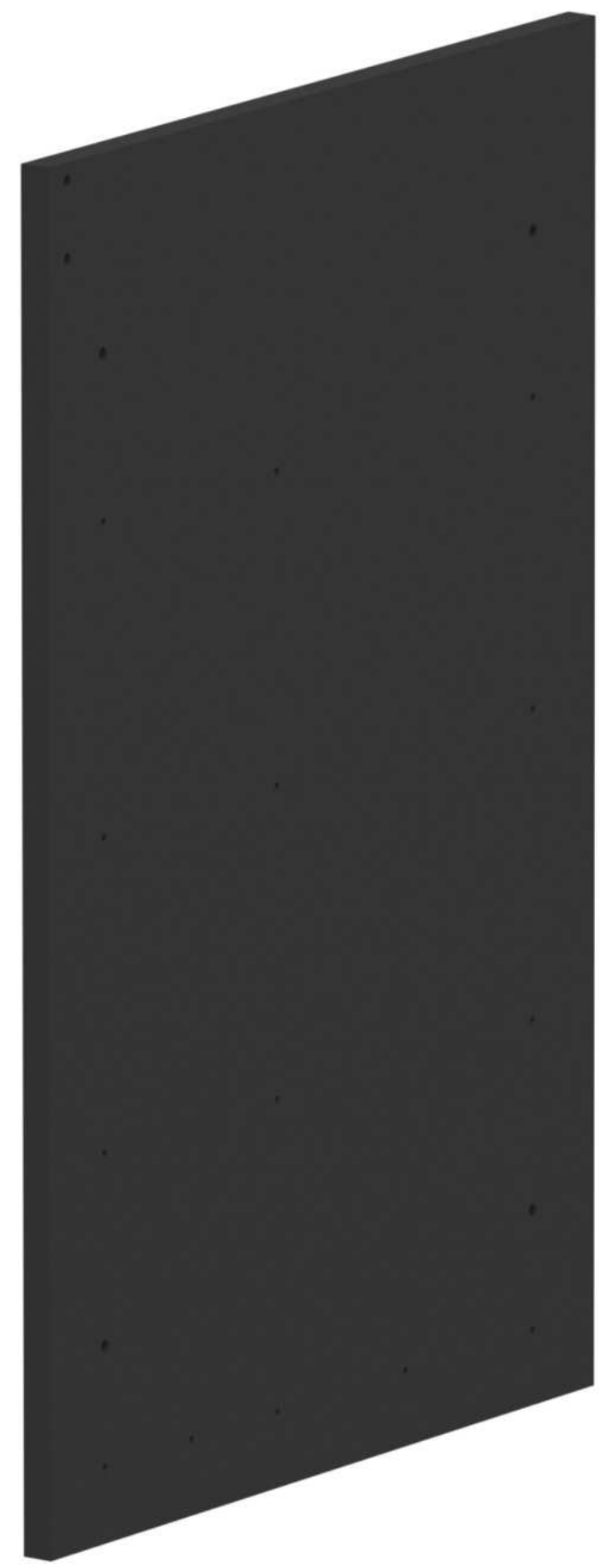
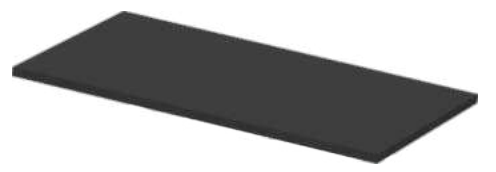

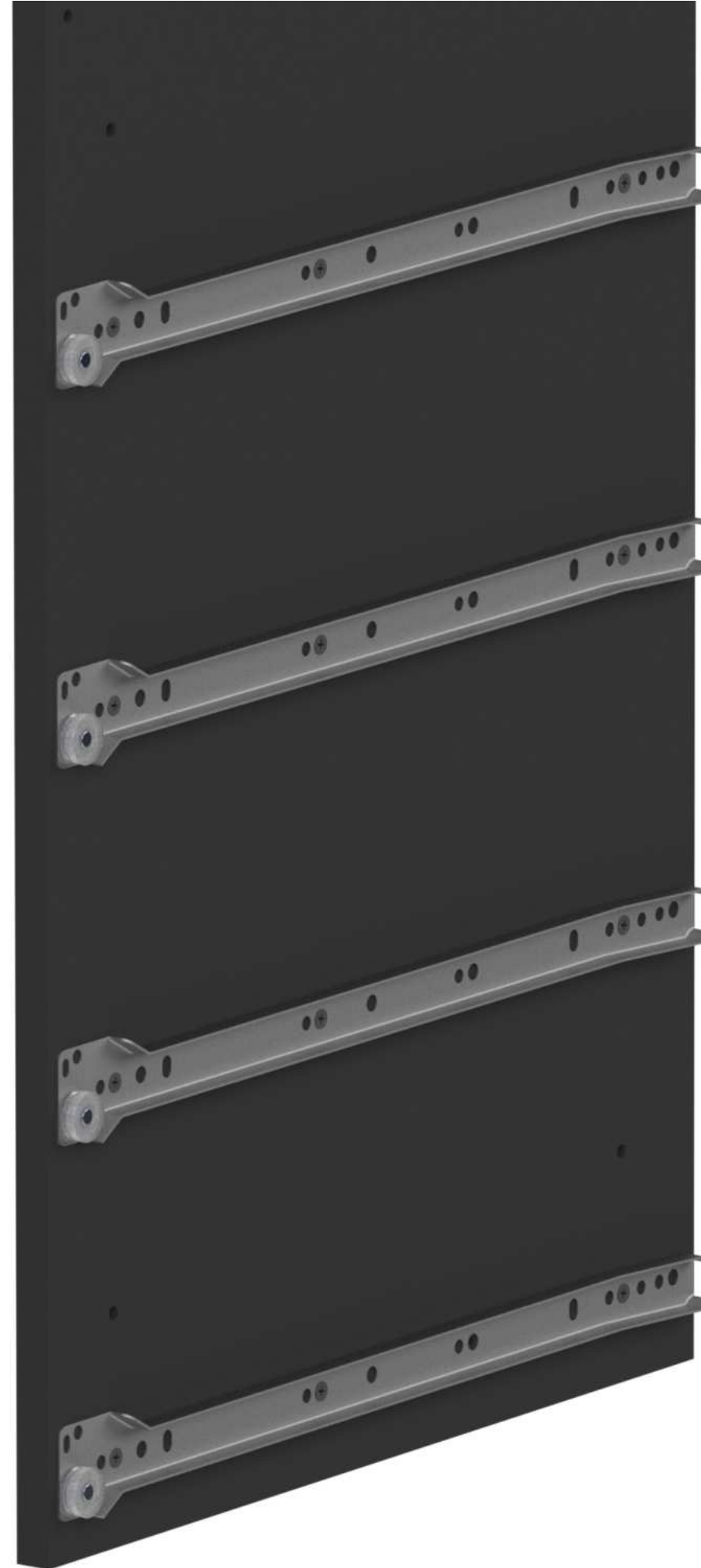
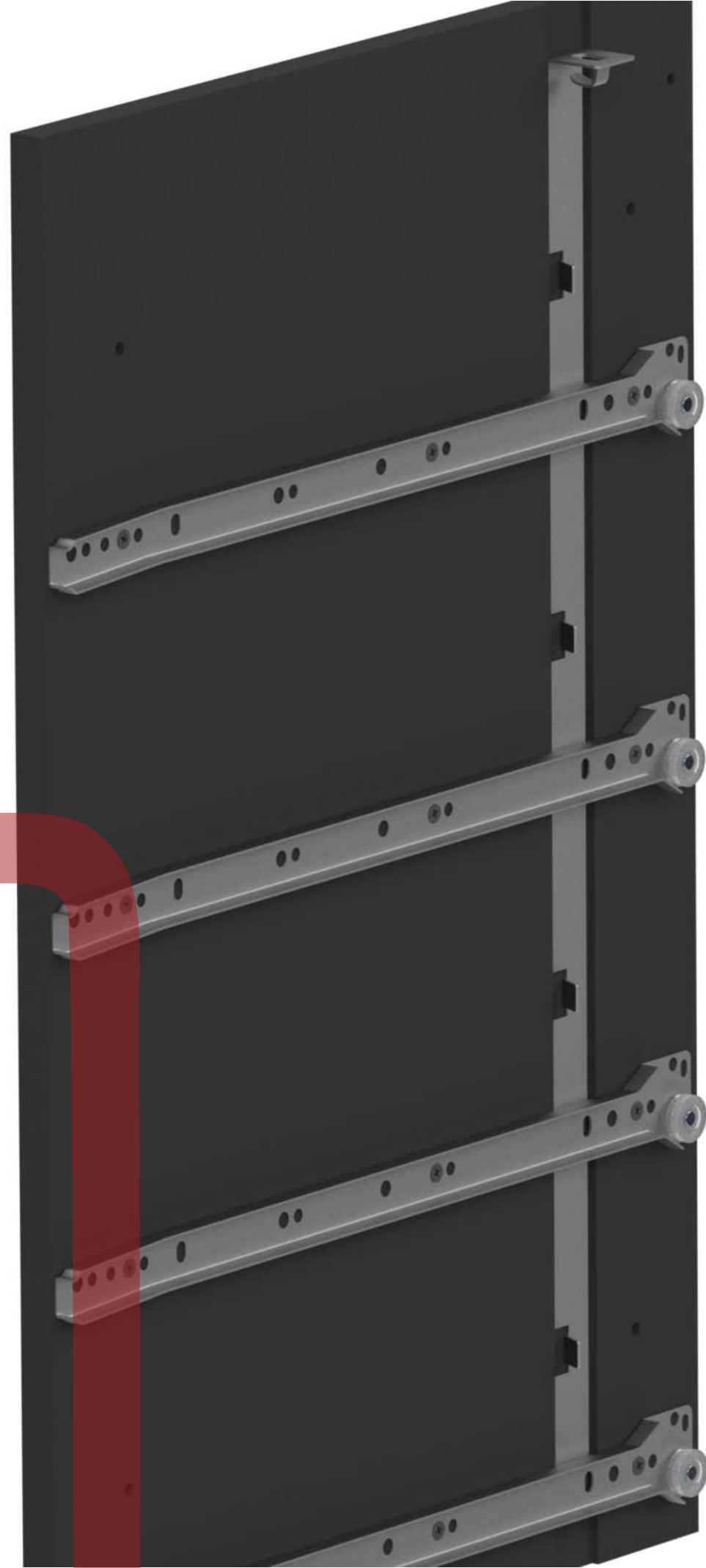

594

02

Trilho Corrediça Par

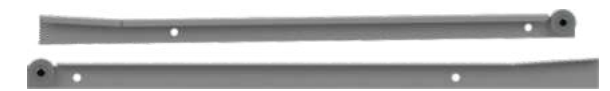

825

12

Parafuso 4x14mm



5988



04

Suporte Fixação 14x20

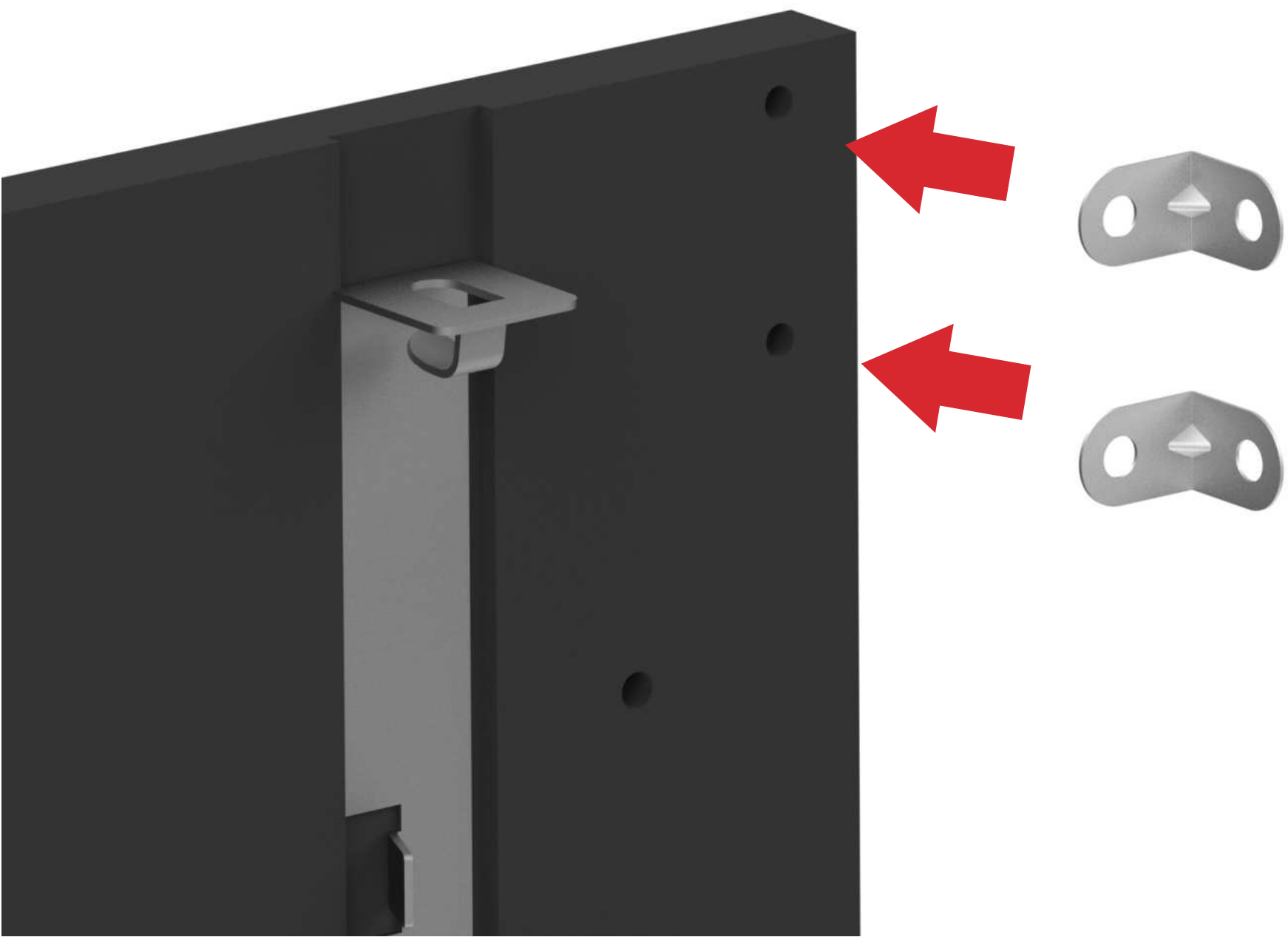

840

04

Parafuso 6x10mm

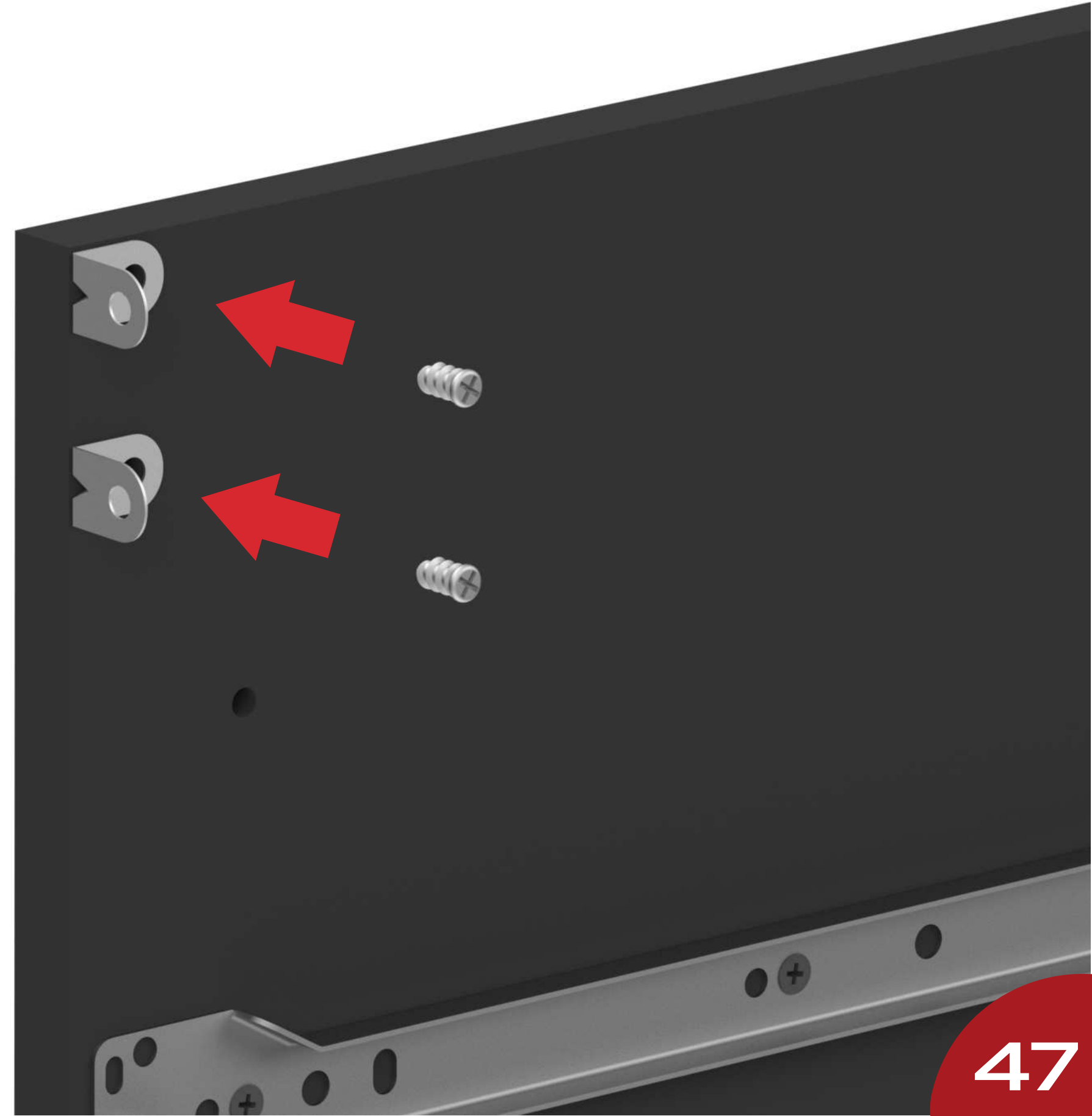
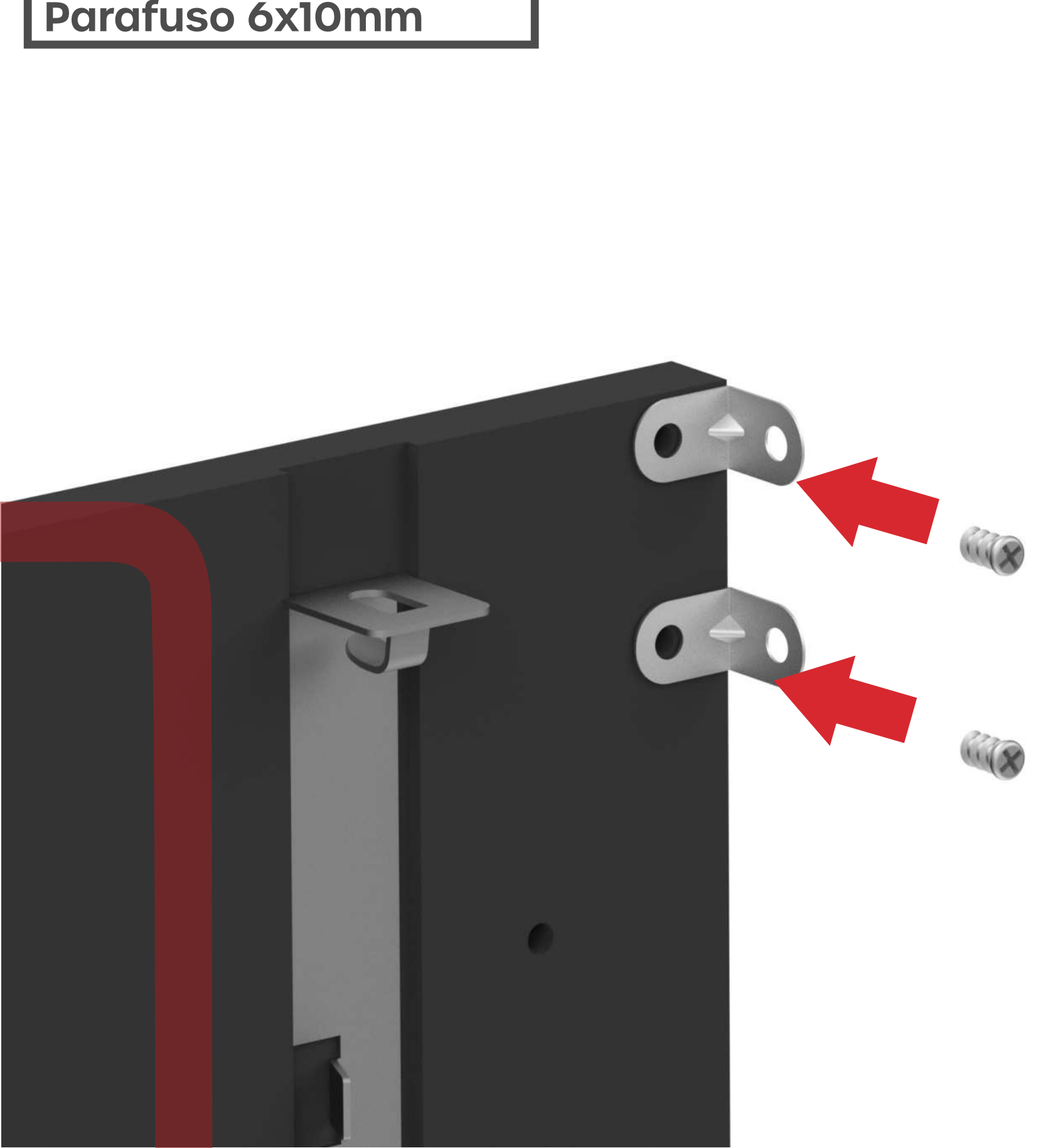



**634
01**



Fechadura Articulado

**9601
01**



Travessa Fechadura





5988



01

Suporte Fixação 14x20

840

29

Parafuso 6x10mm



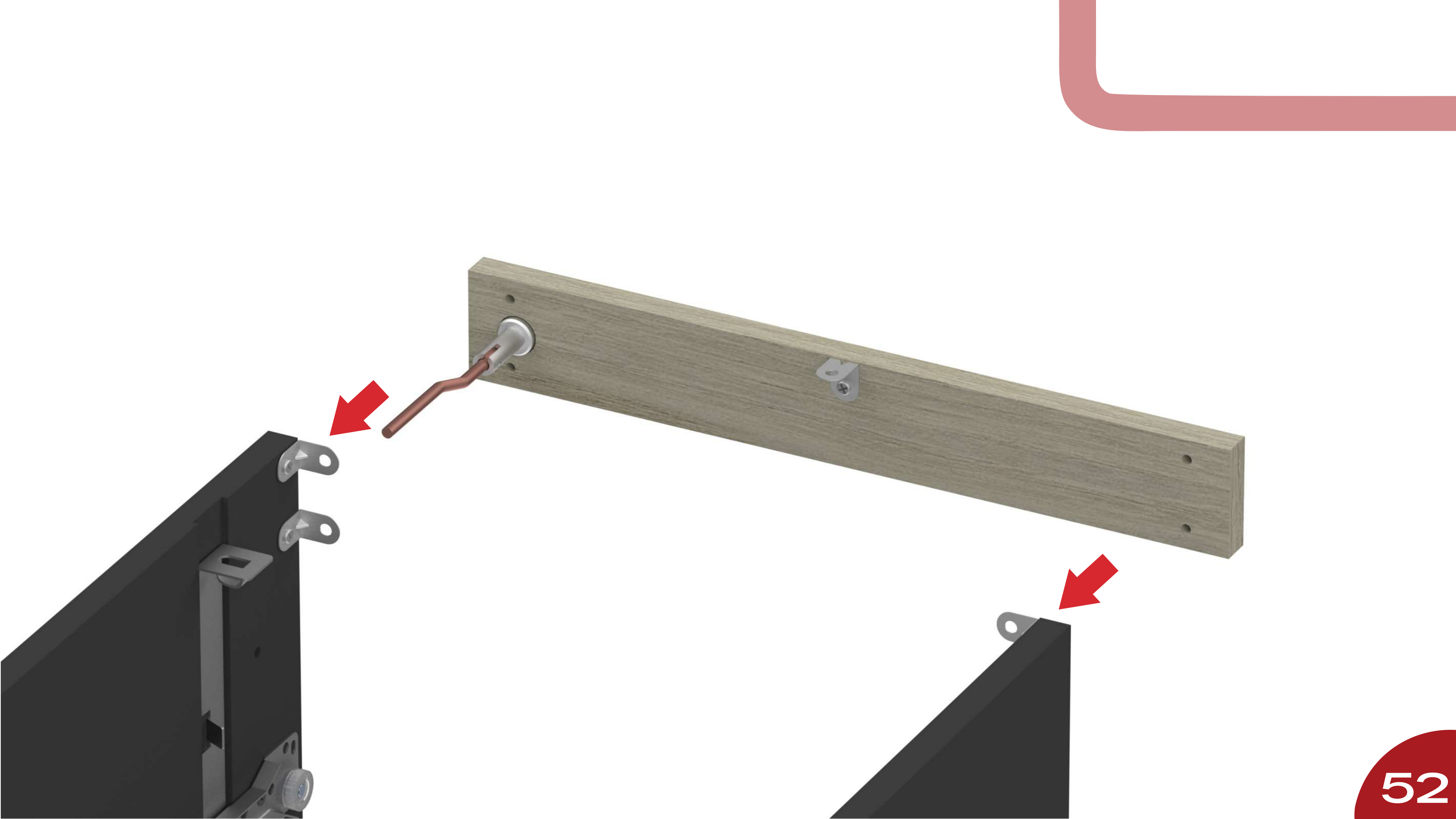

840

02

Parafuso 6x10mm

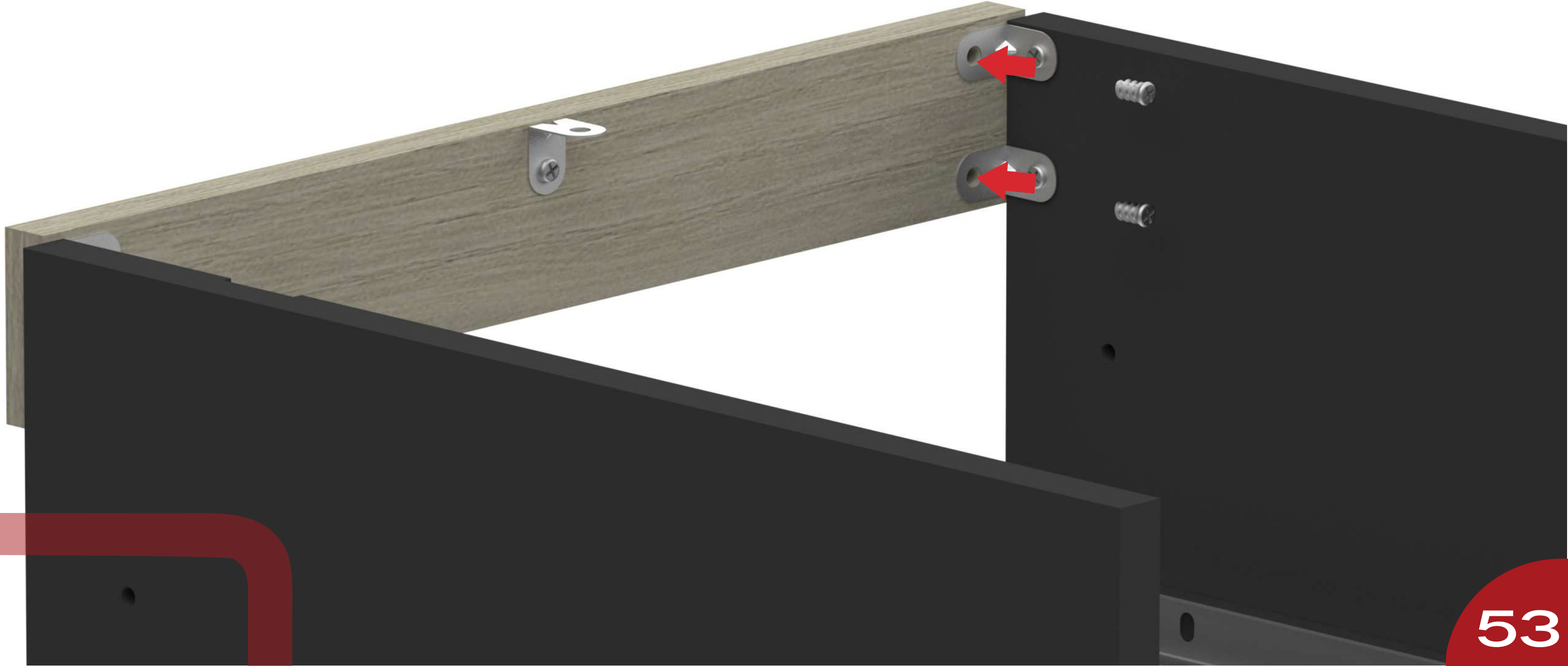

840

02

Parafuso 6x10mm

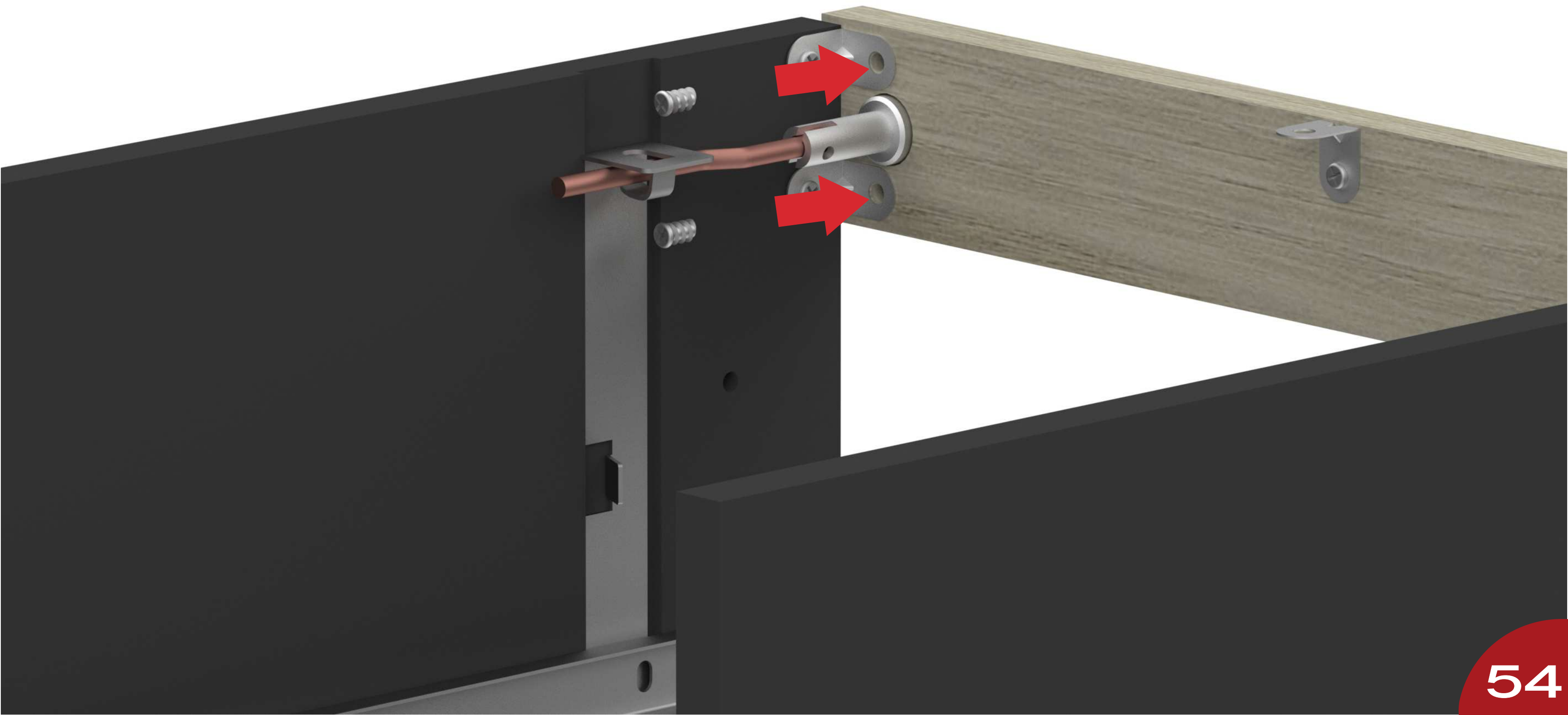





833

04

Parafuso 4x25mm





833
04
Parafuso 4x25mm



9587

01

Prateleira Externa

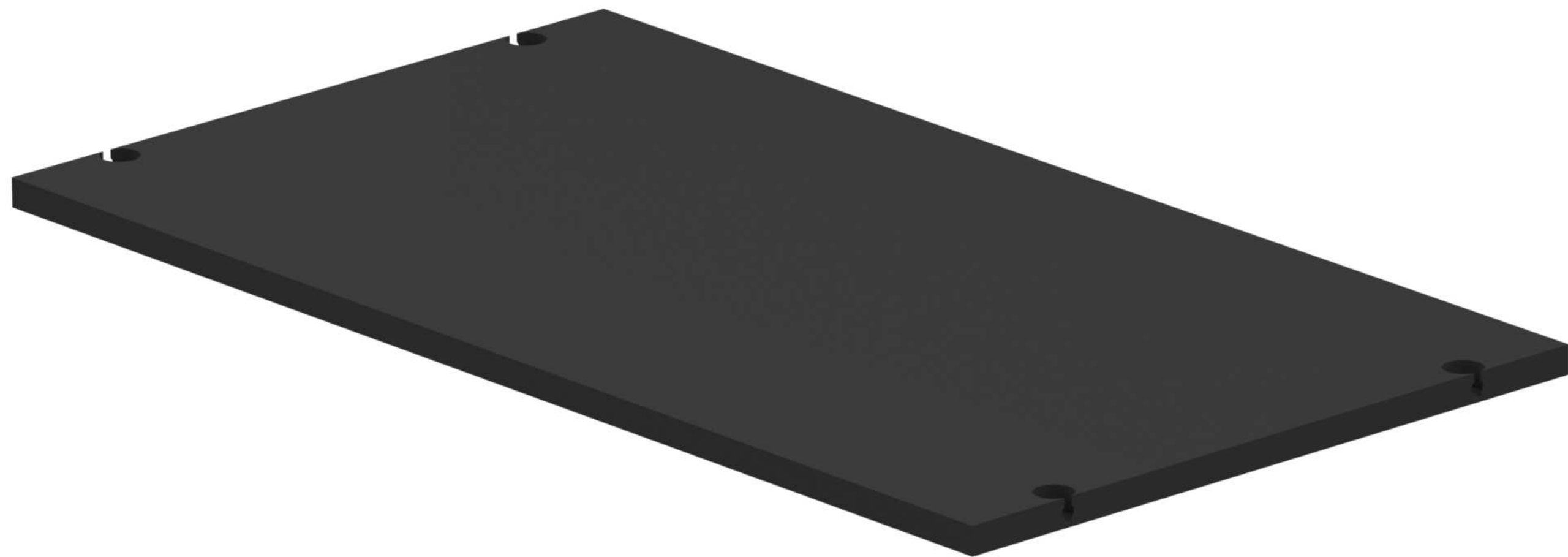

759

08

Dispositivo Vb35 M16

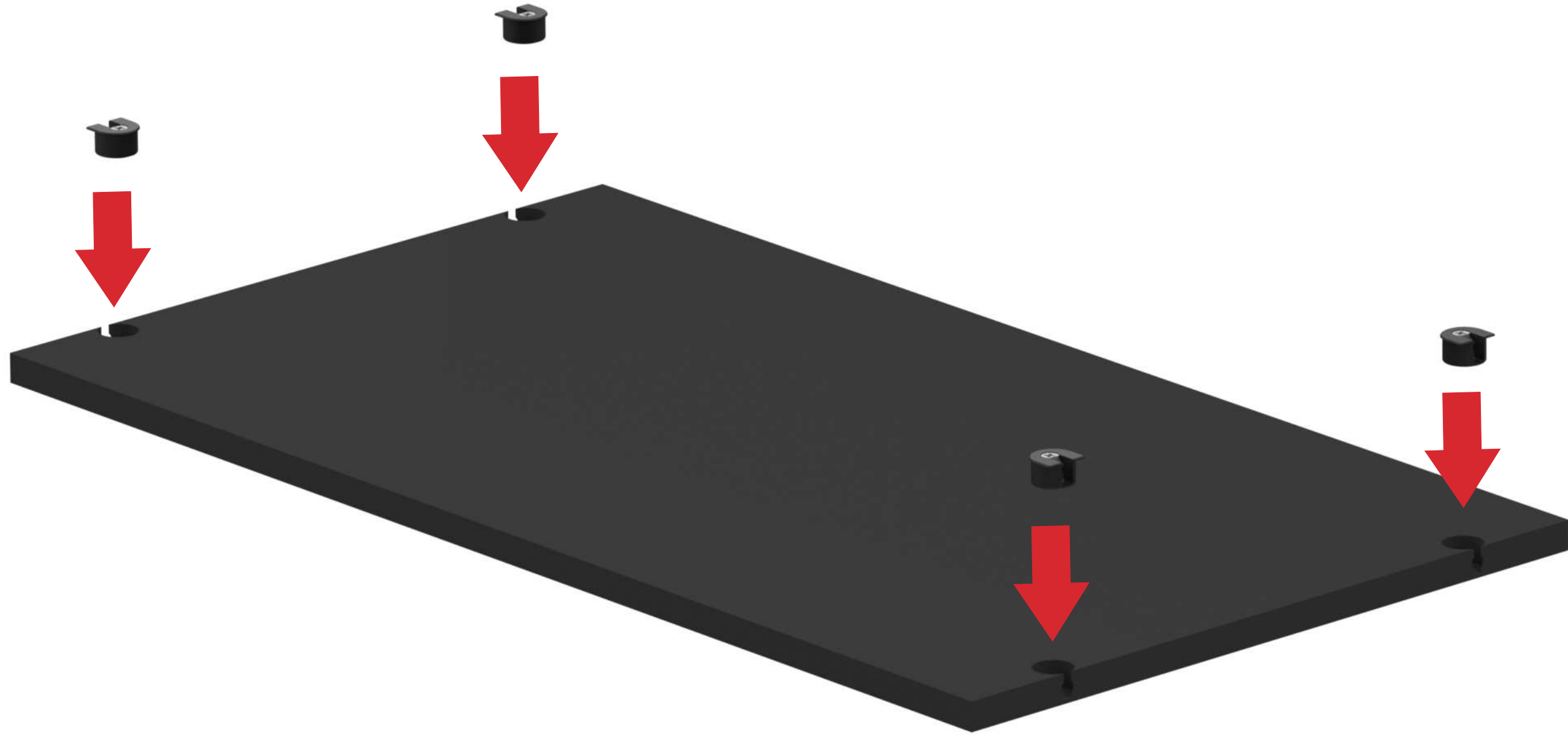





9592

01

Porta Esquerda



1505

01

Suporte Aço Fixação



825



02

Parafuso 4x14mm



637

01

Kit Sis-Flex

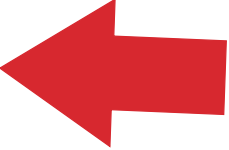
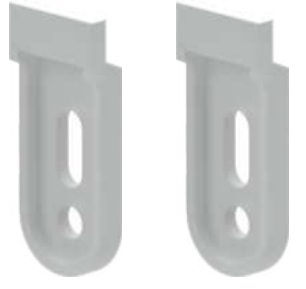



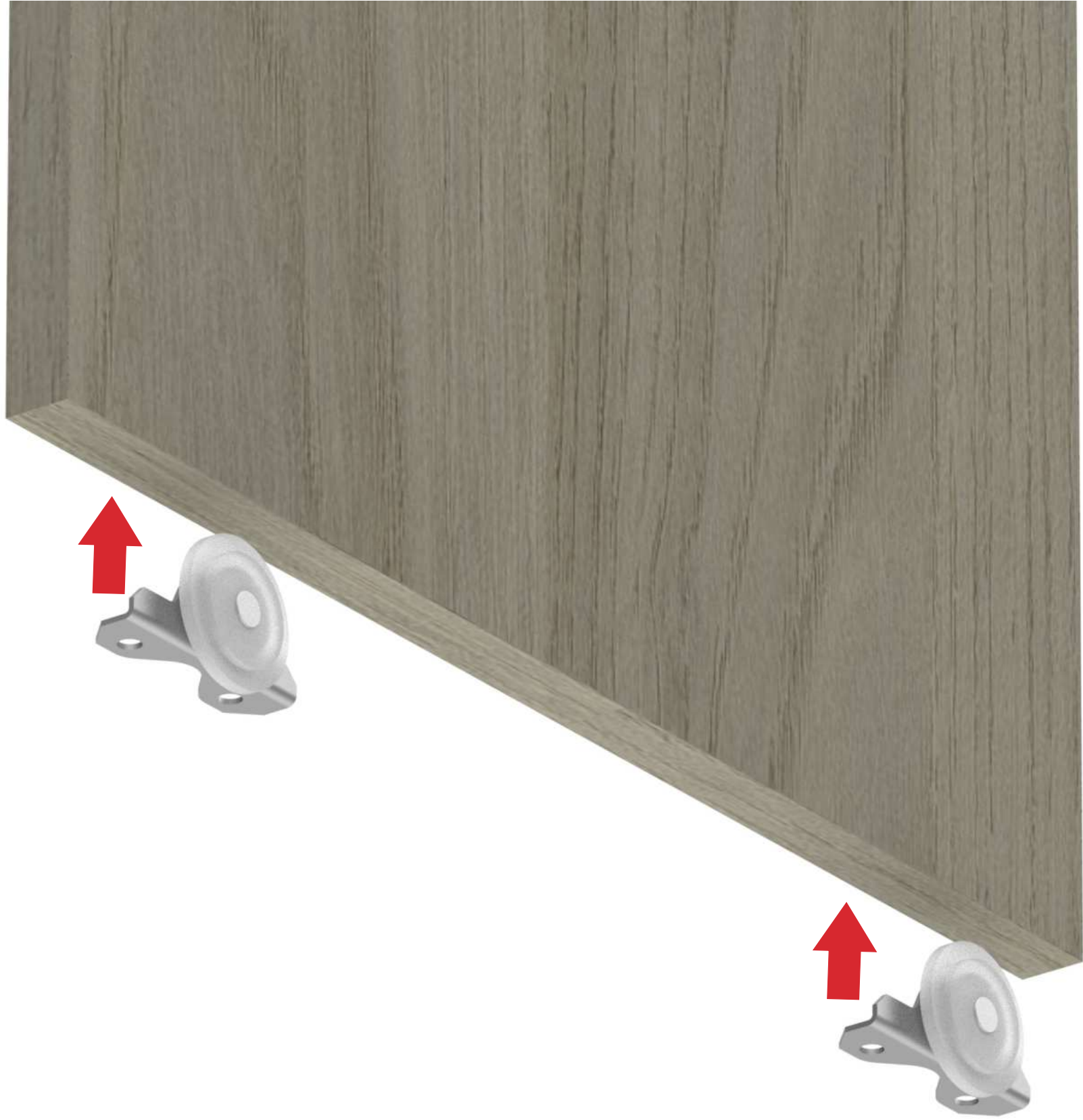

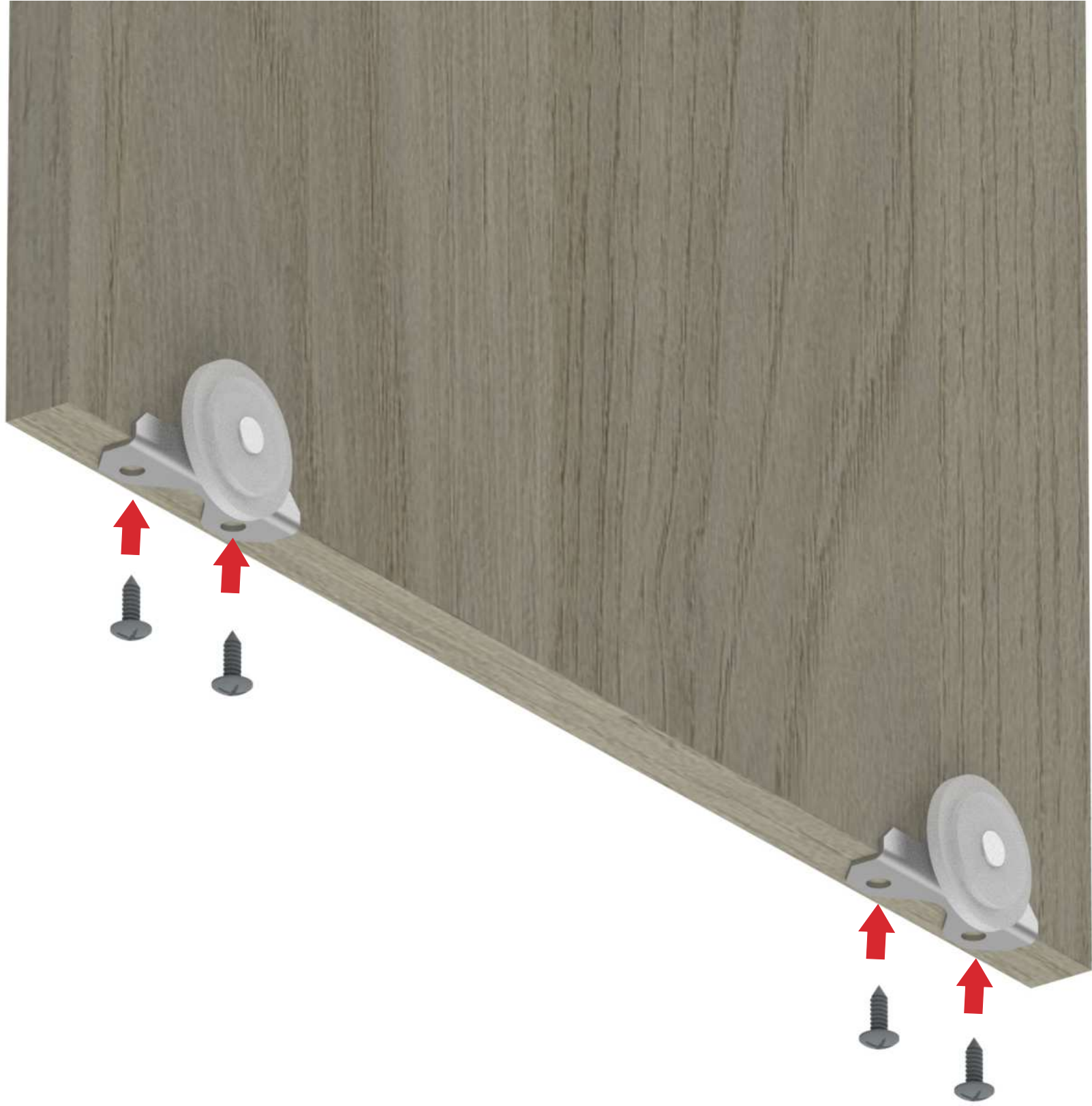

4880

01

Puxador Aço



825

04

Parafuso 4x14mm













9590

01

Porta Direita



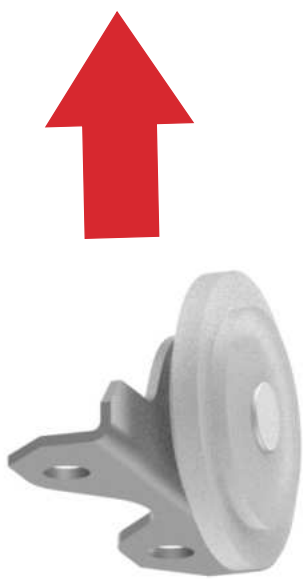
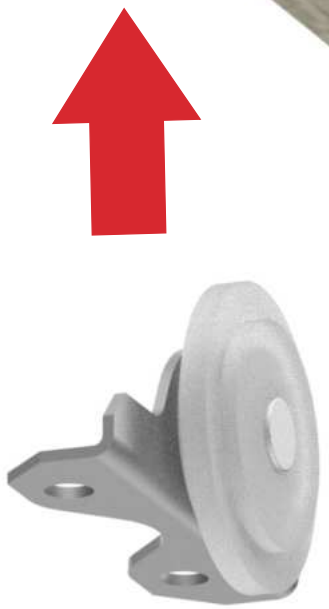
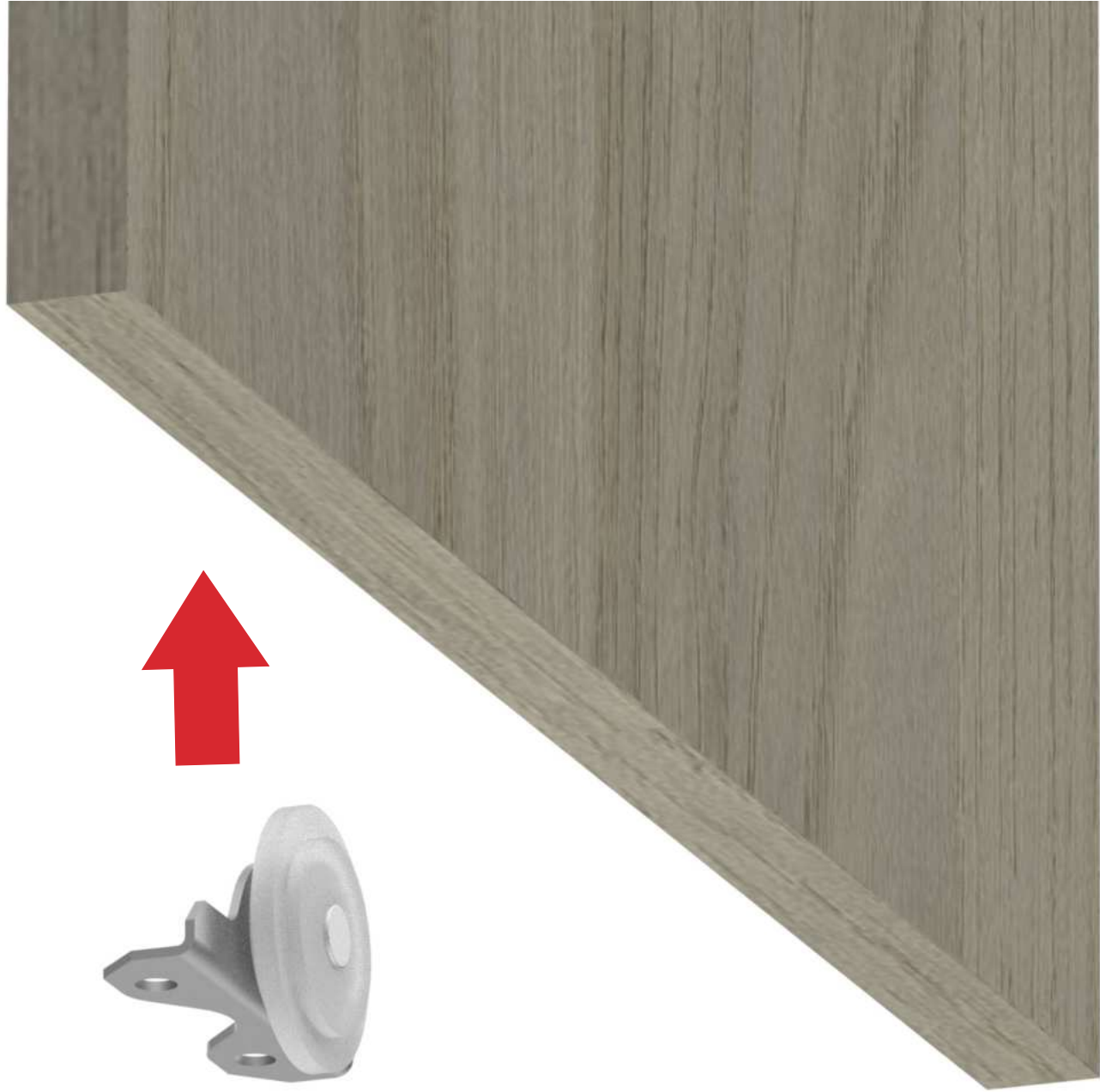

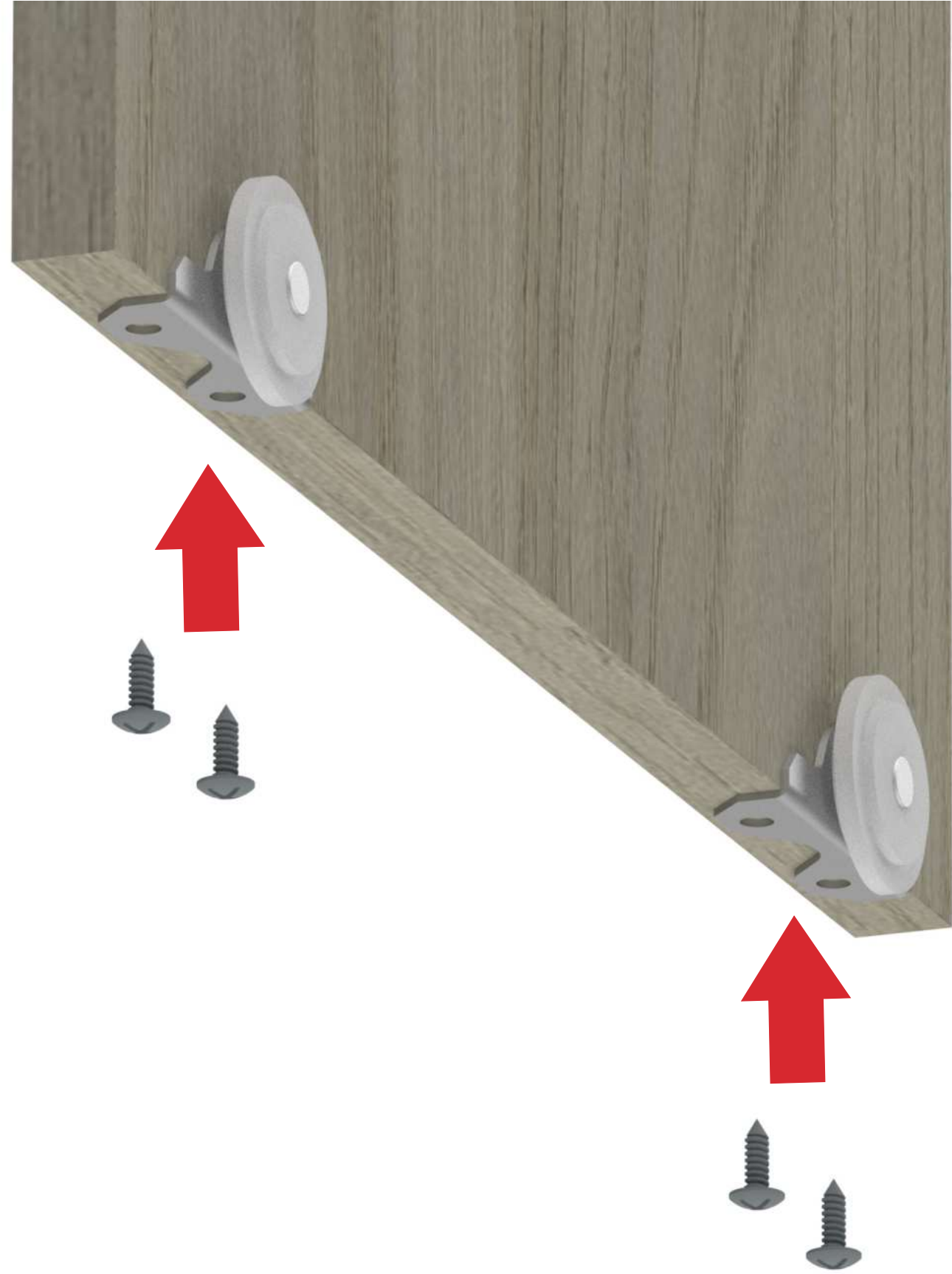

692

01

Fechadura 421

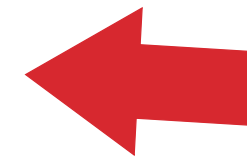

825

02

Parafuso 4x14mm







4880

01

Puxador Aço



825



04

Parafuso 4x14mm













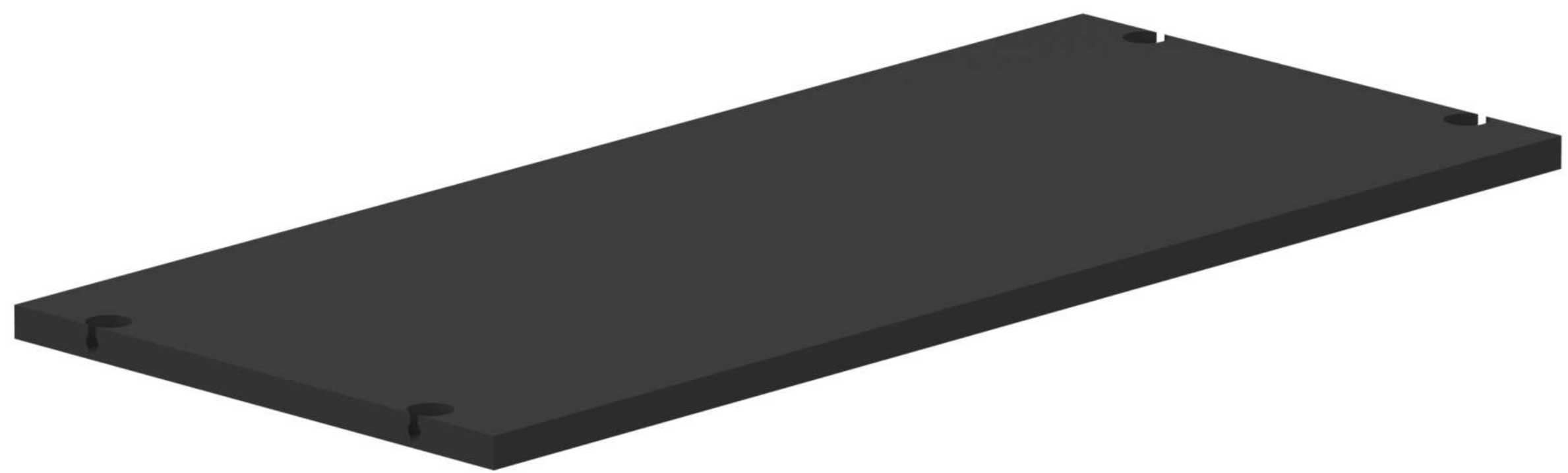

9585

01

Prateleira Central



759

04

Dispositivo Vb35 M16

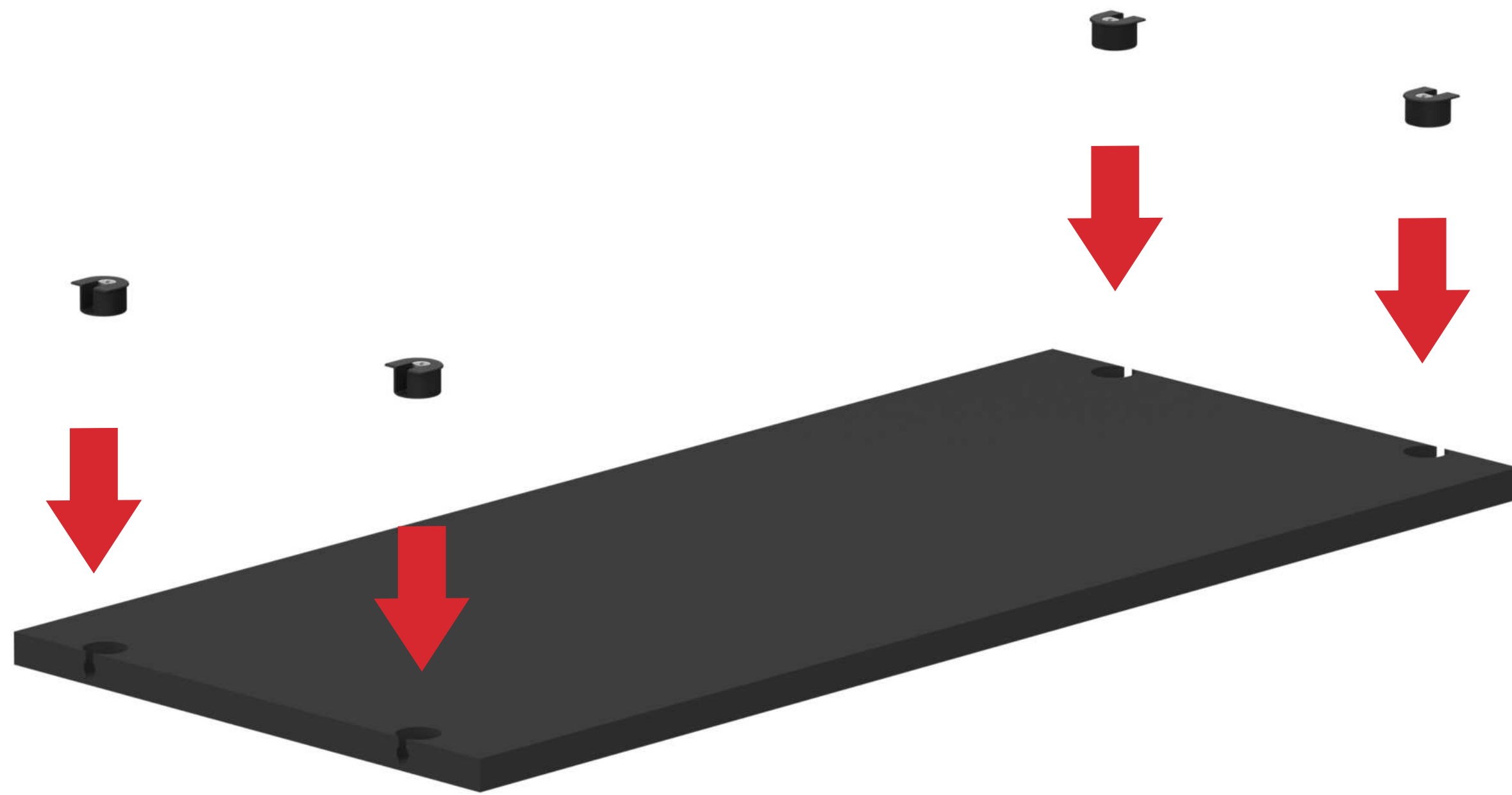



825



01

Parafuso 4x14mm



838
04
Parafuso 4,5x50mm



1545

04

Corpo de Gaveta

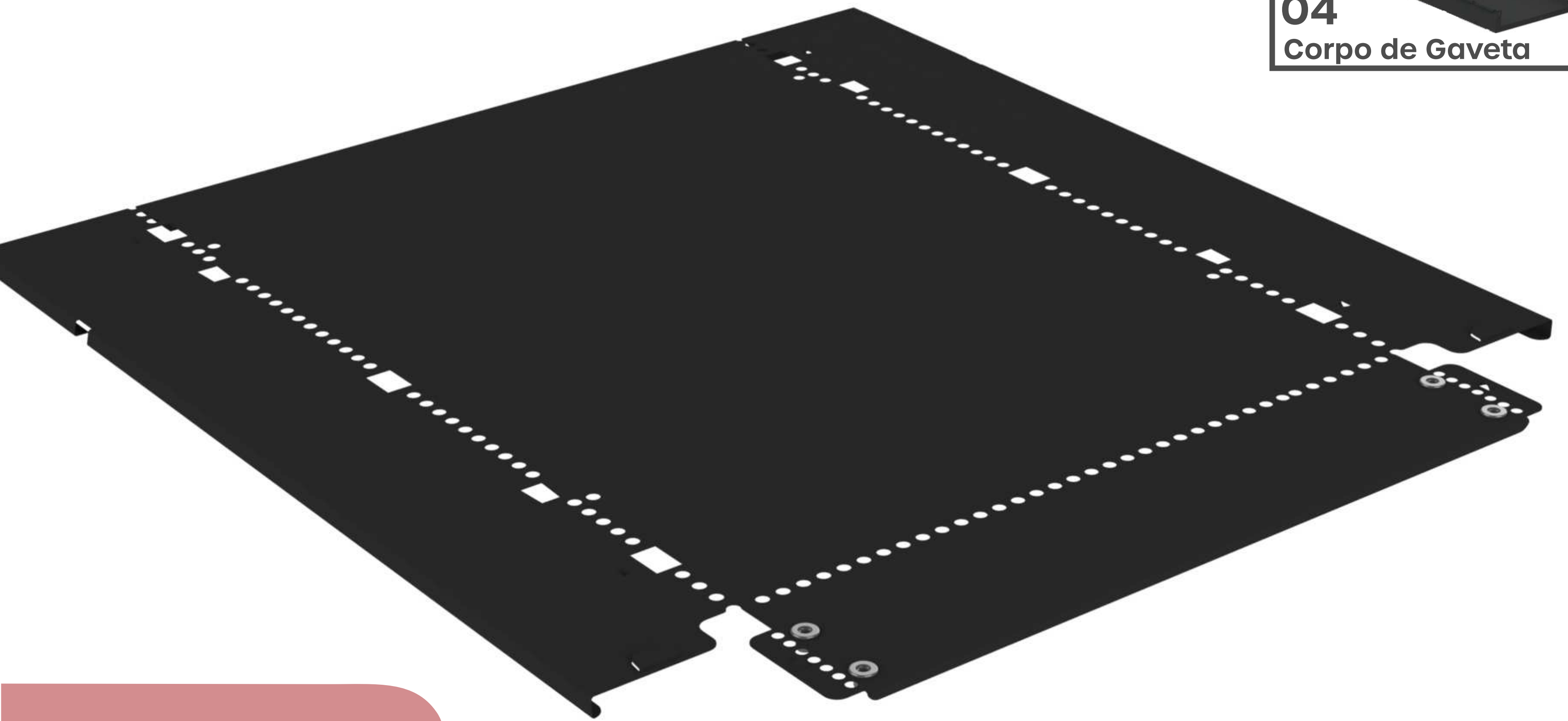



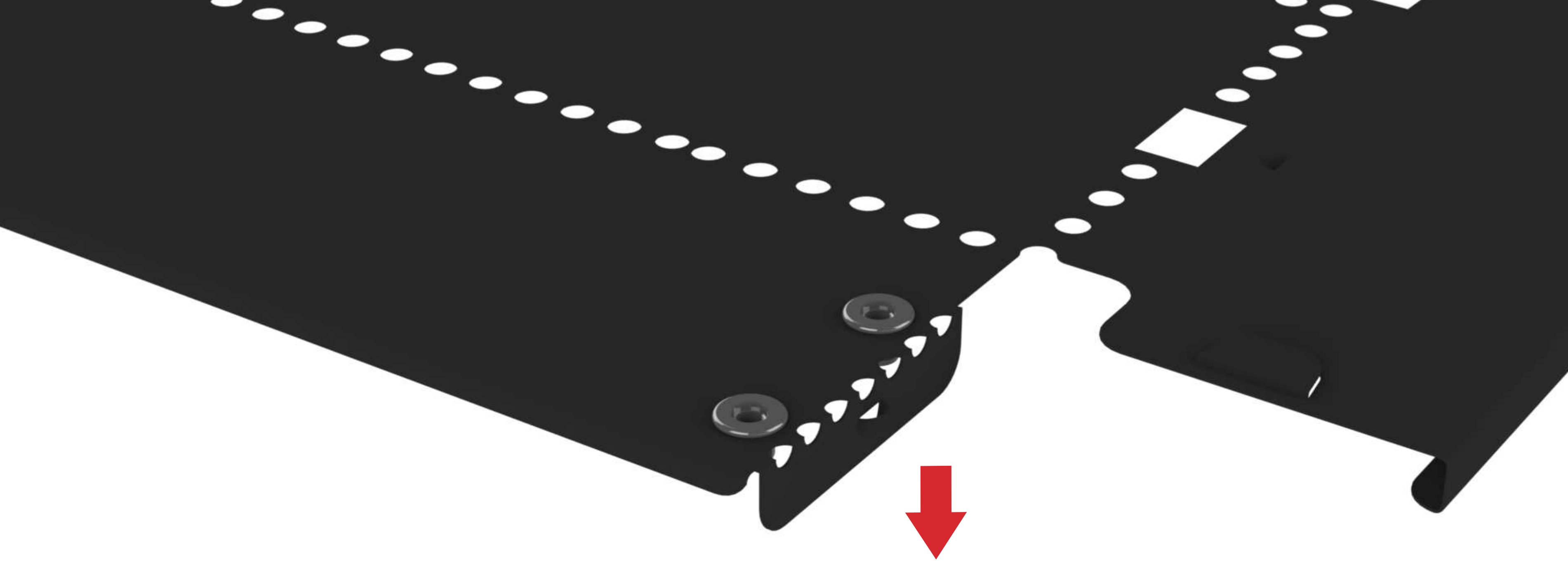

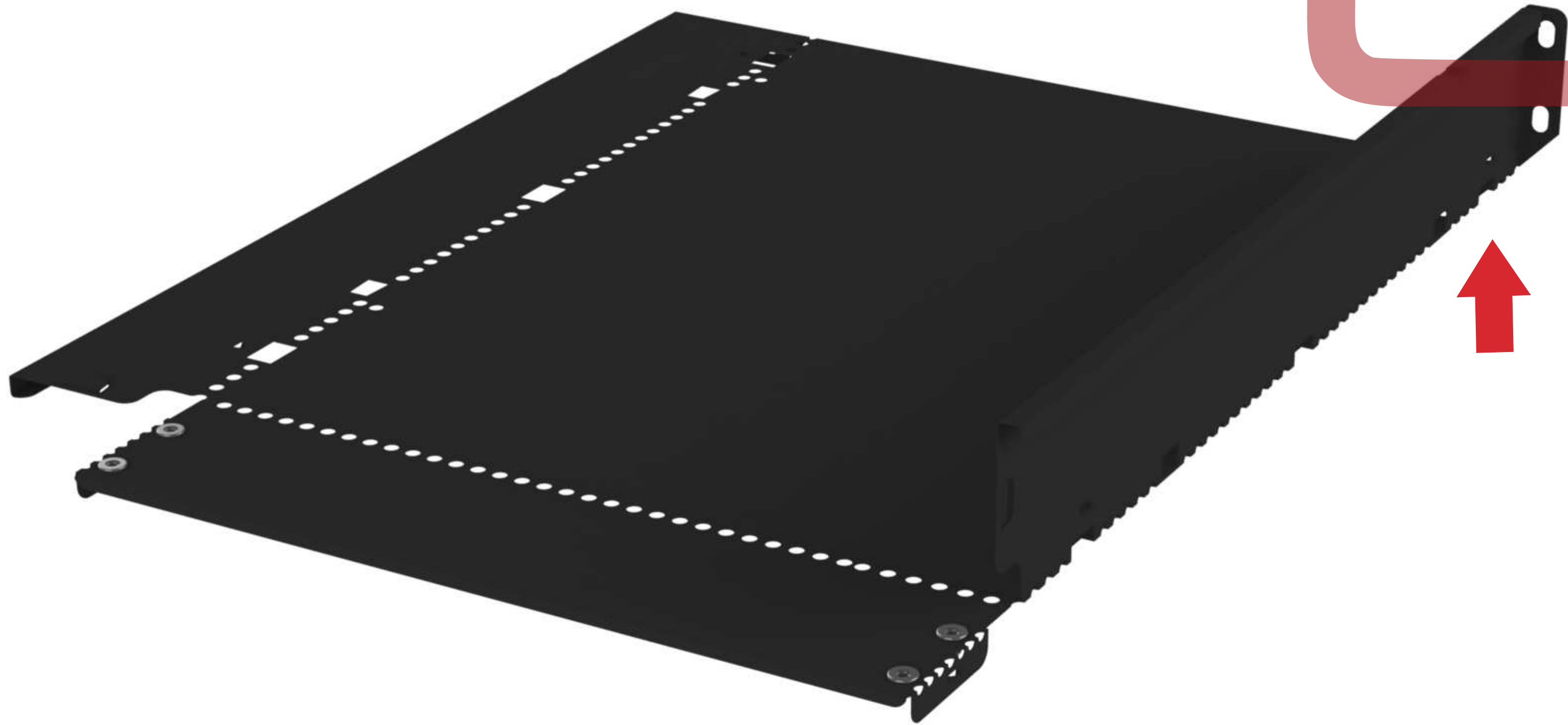

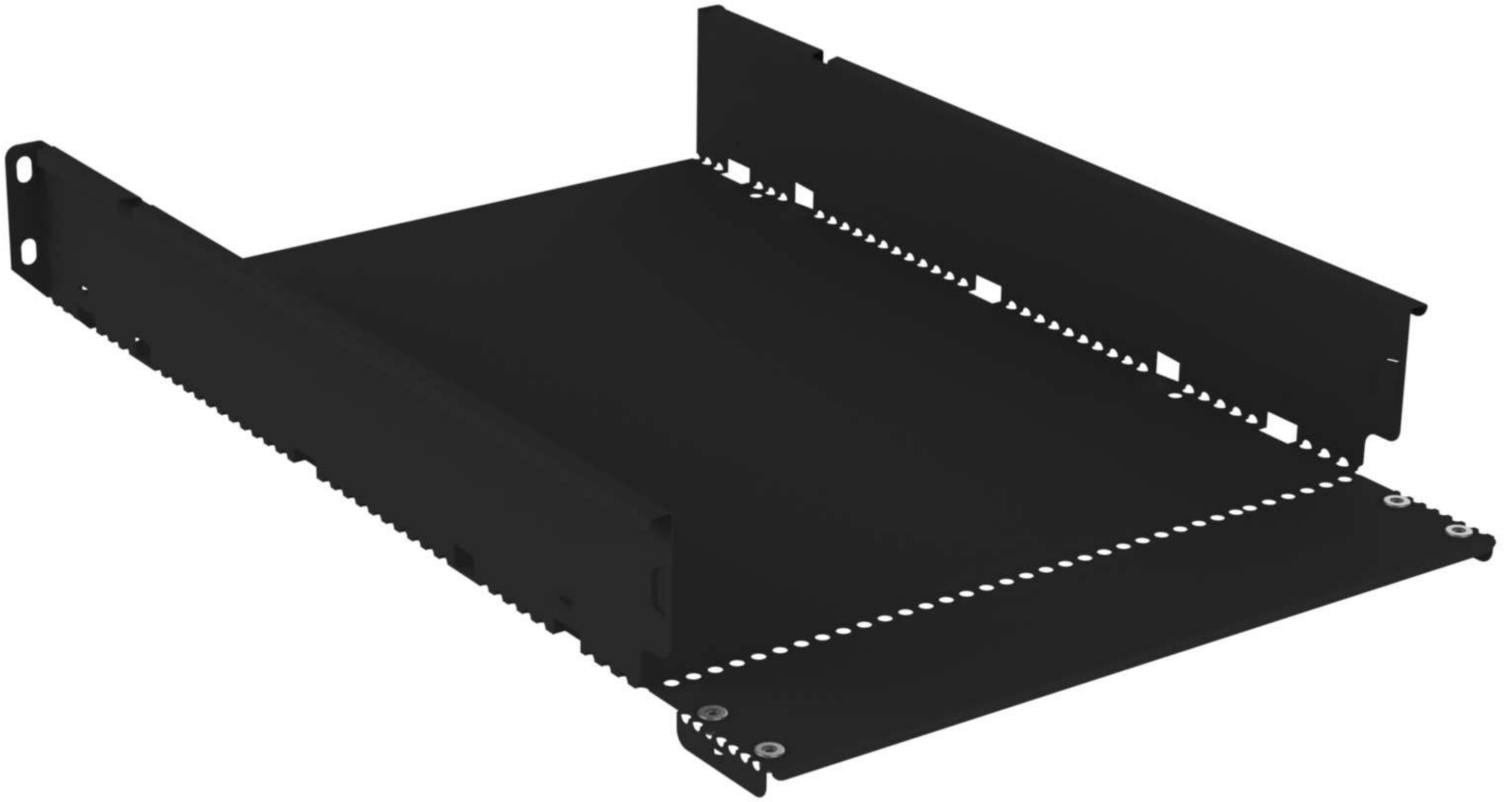

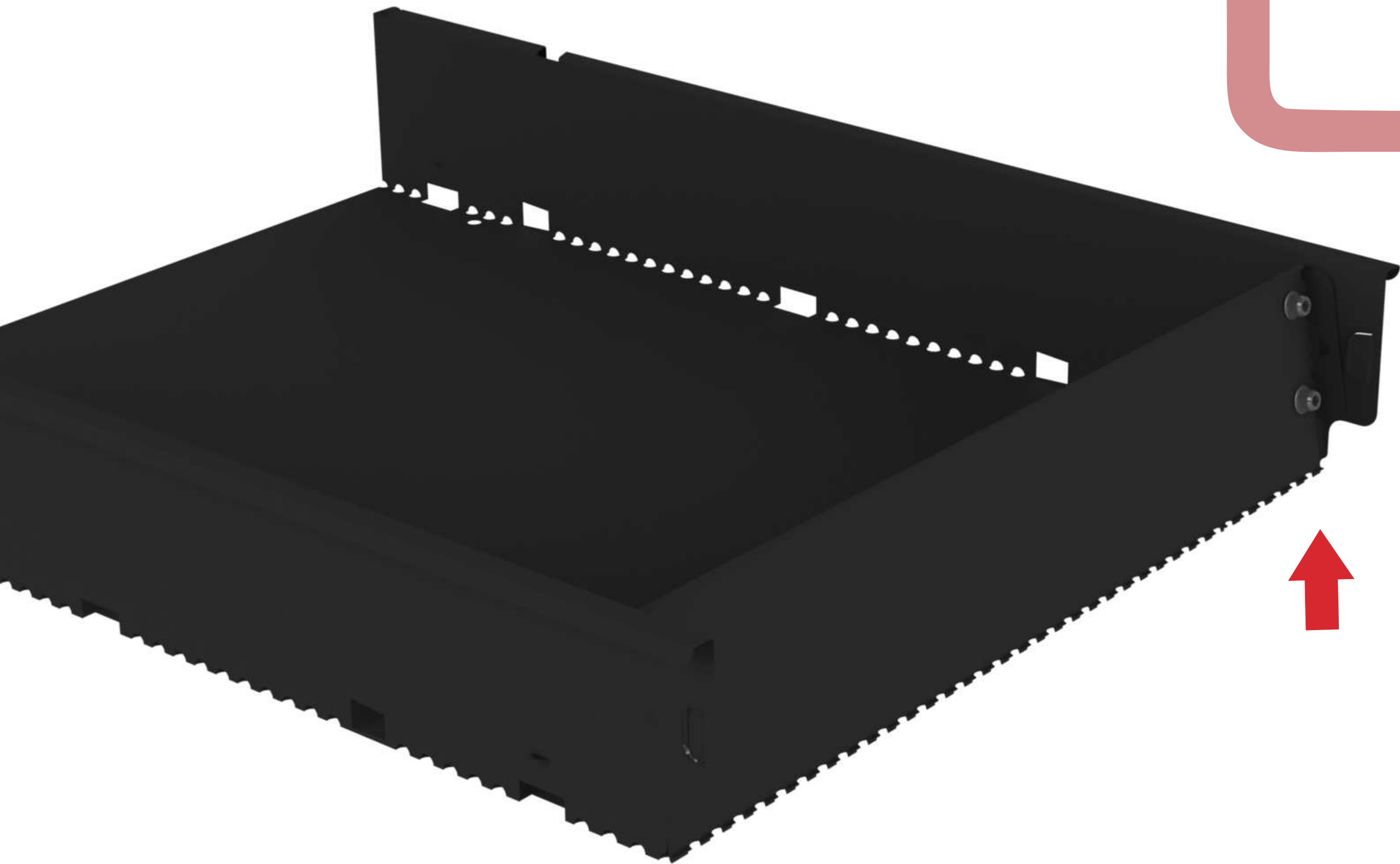



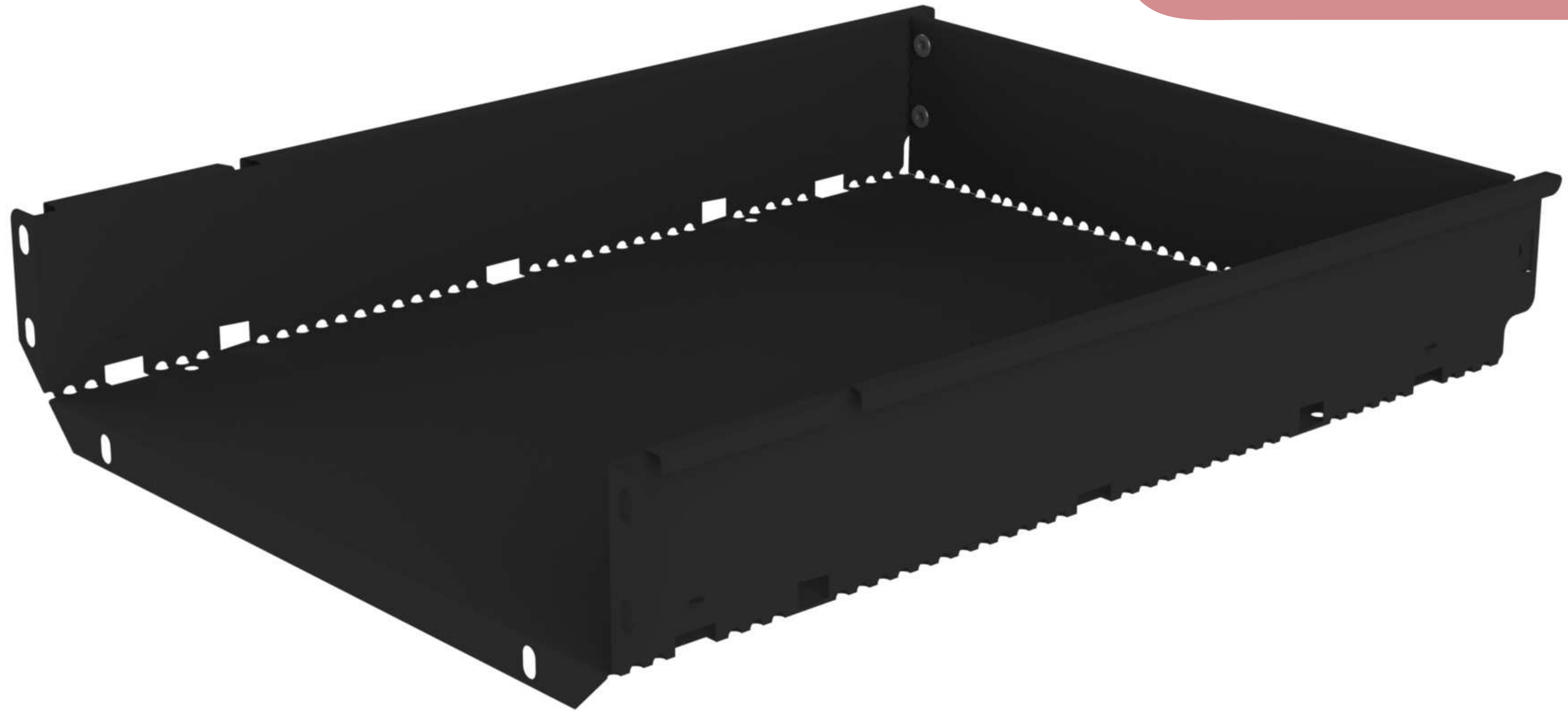

594

01



Trilho Corrediça Par

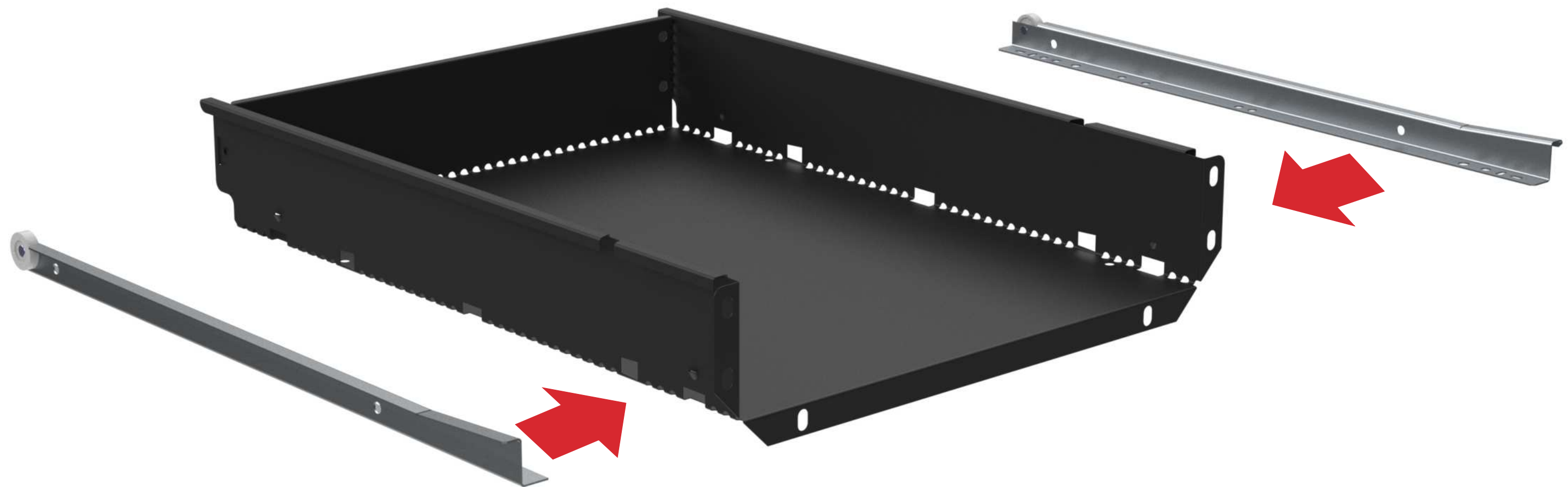

844

04

Parafuso M4x0,6mm

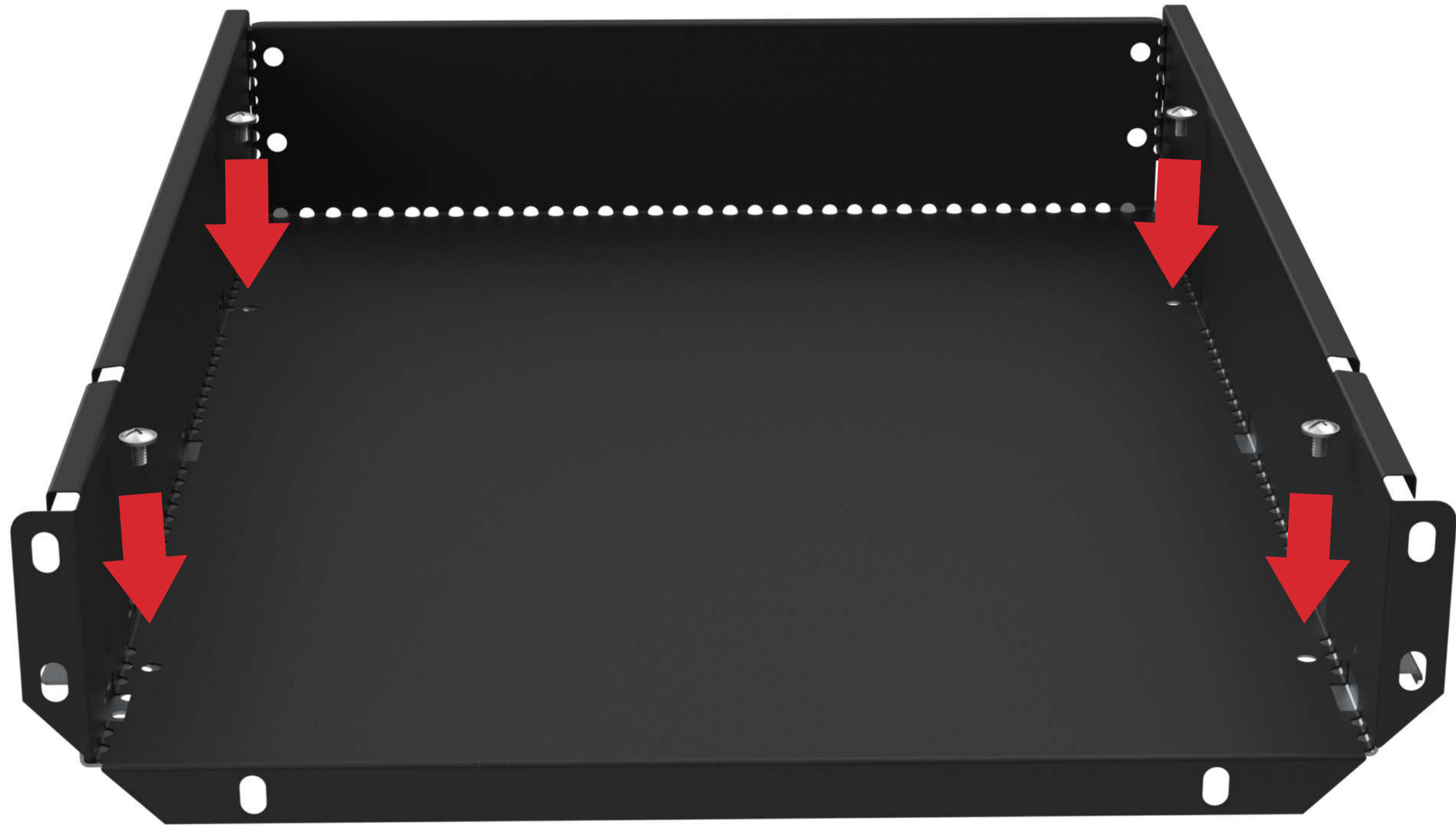

892

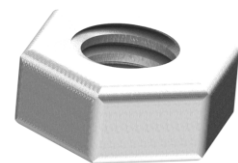

04

Porca Sextavada M4

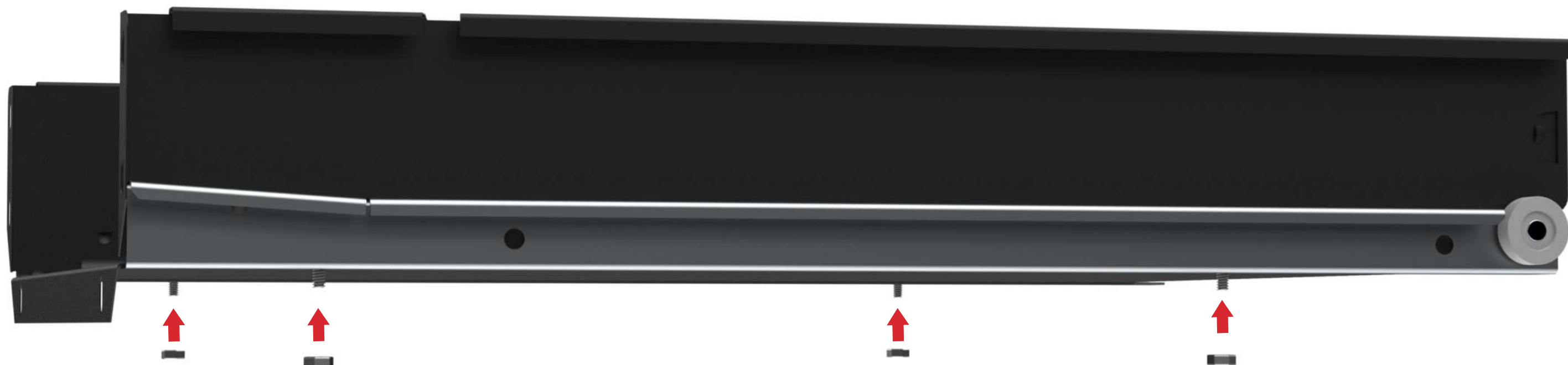

9599

01

Frente de Gaveta



840

01

Parafuso 6x10mm





840

03

Parafuso 6x10mm



699

01

Puxador Plástico



831

02

Parafuso 3,5x22mm

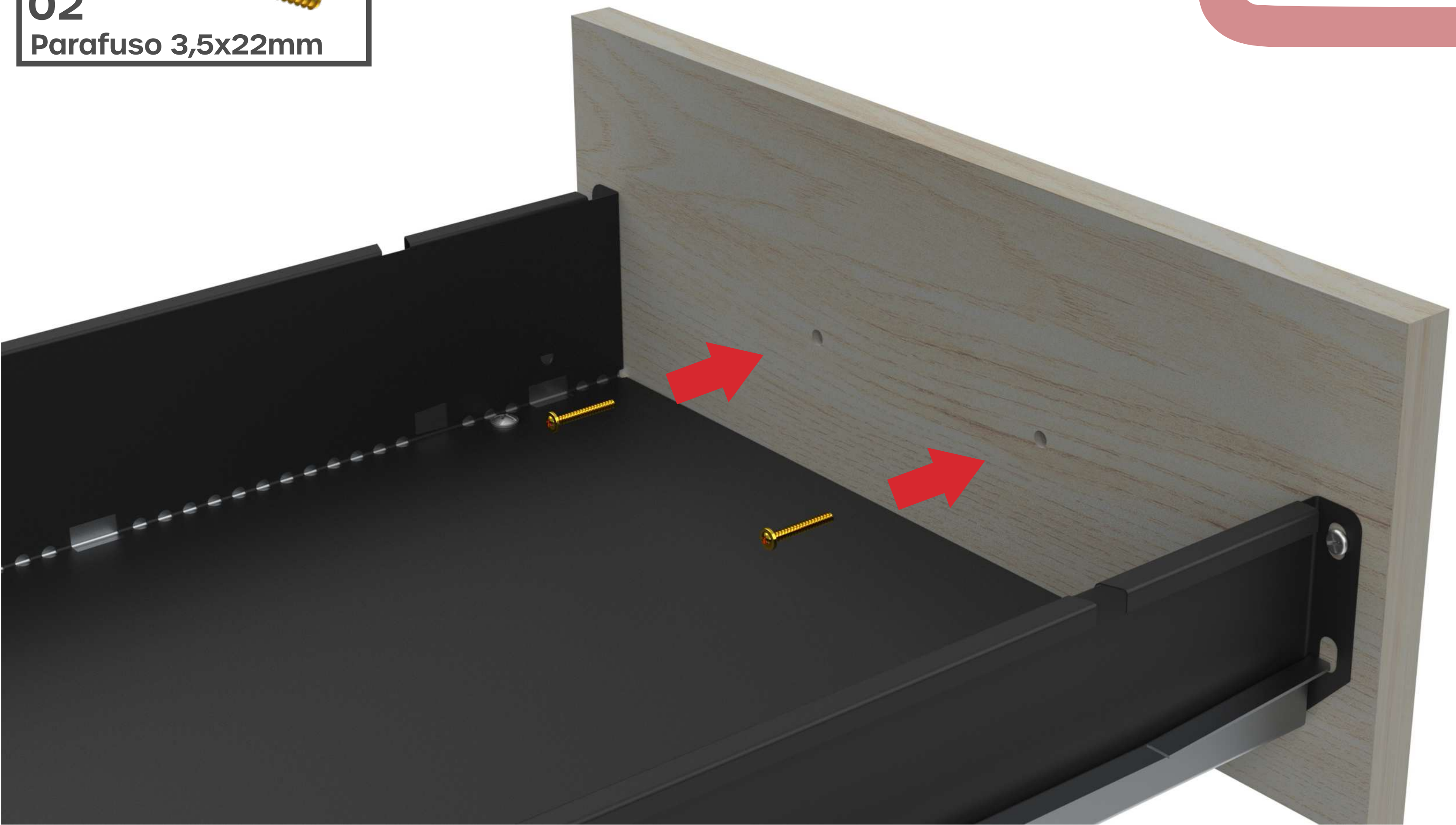







9983



01

Caixa Tomada Preto







18,1 cm

825



01

Parafuso 4x14mm

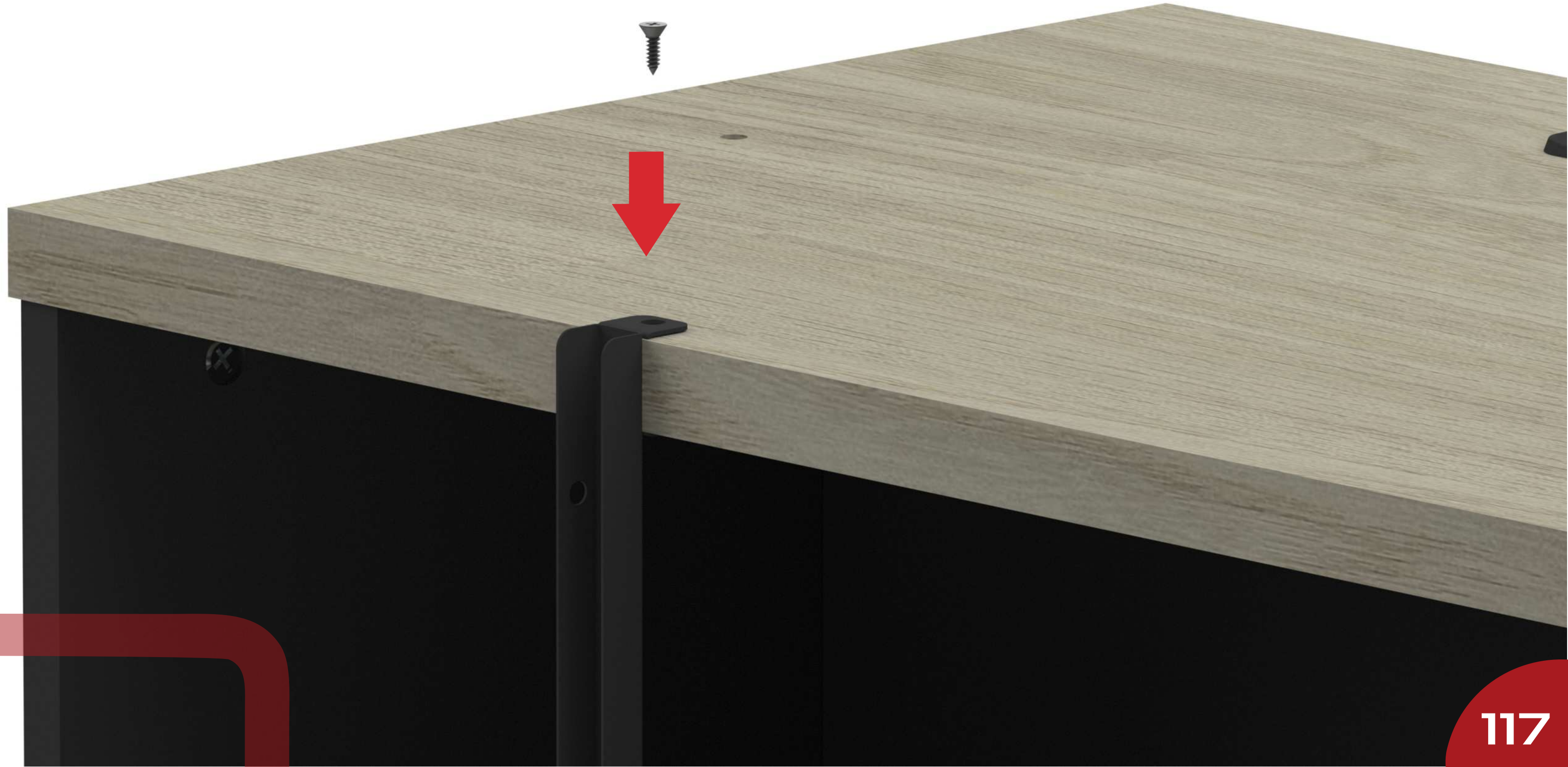

825



01

Parafuso 4x14mm



6183

01

Pé Dir/Esq Mesa

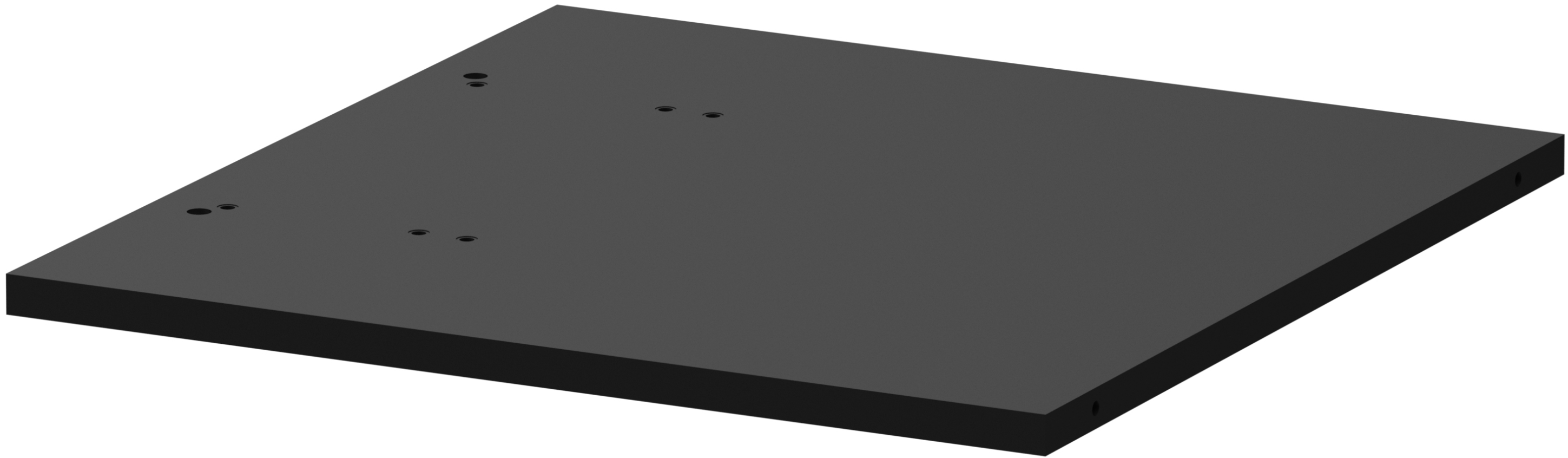

710

03

Suporte Plastico 8/10

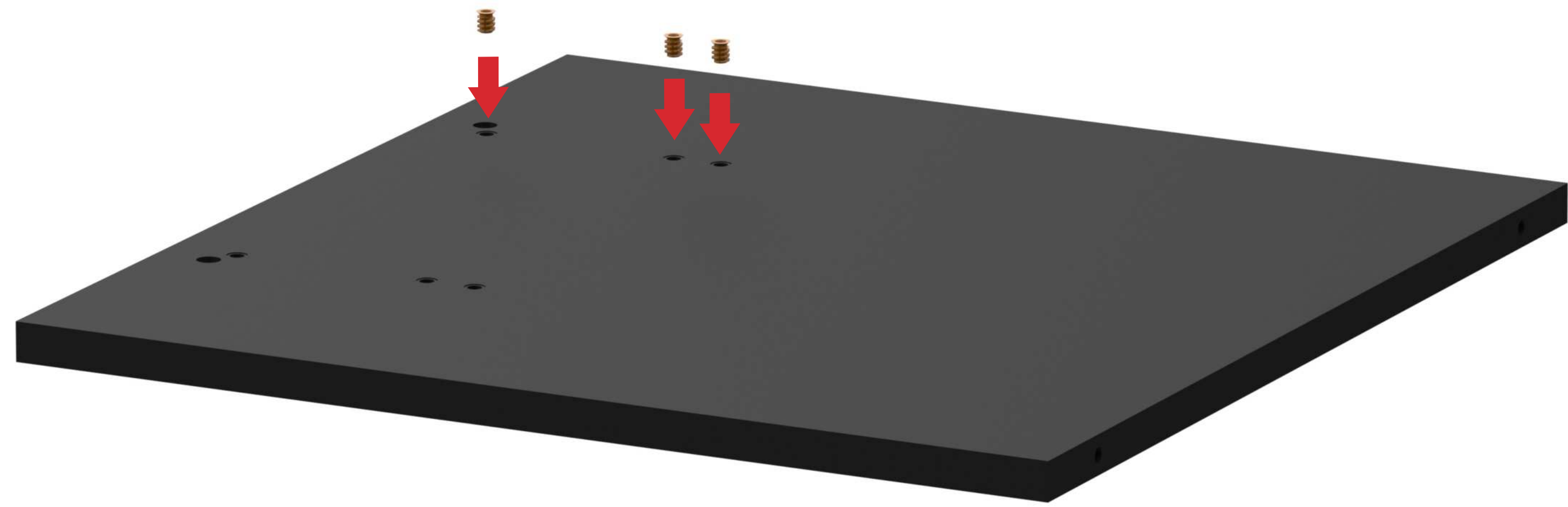

694



03

Pino Girofix 6mm

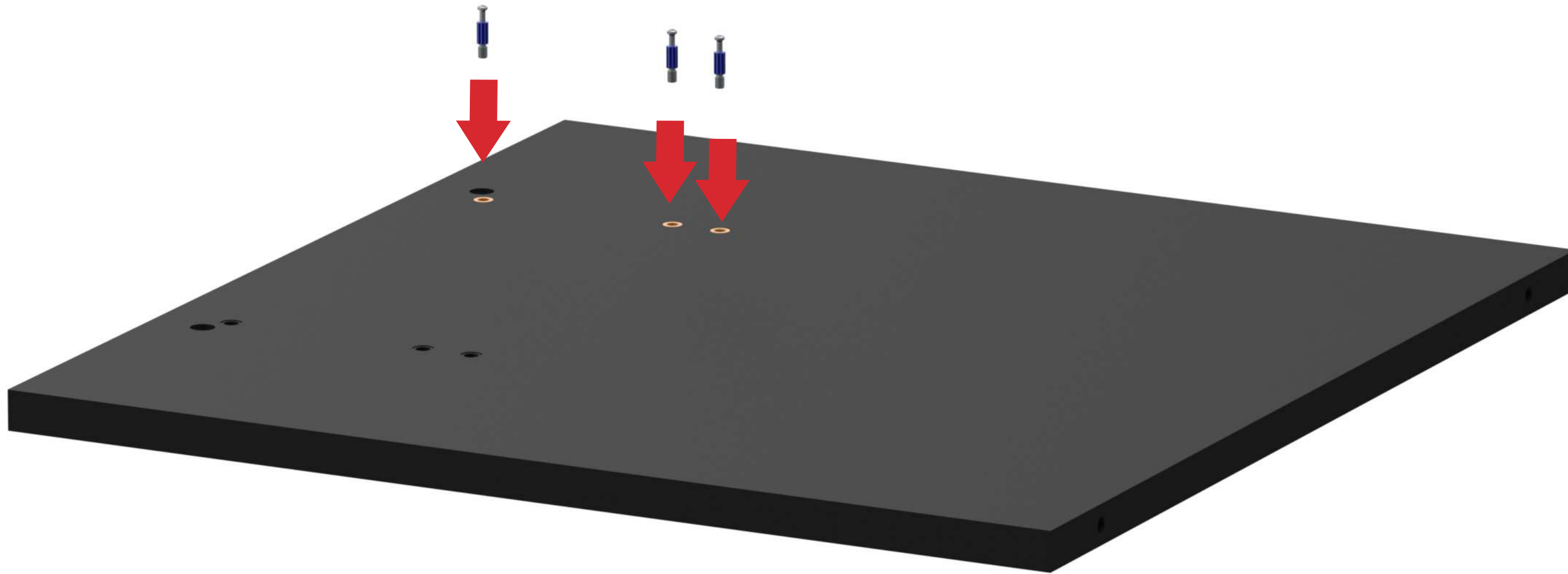

4839



02

Bucha Americana 1/4



873



02

Pé Nivelador 1/4x3/4



3719

01

Retaguarda Mesa



750



03

Tambor Girofix 15mm

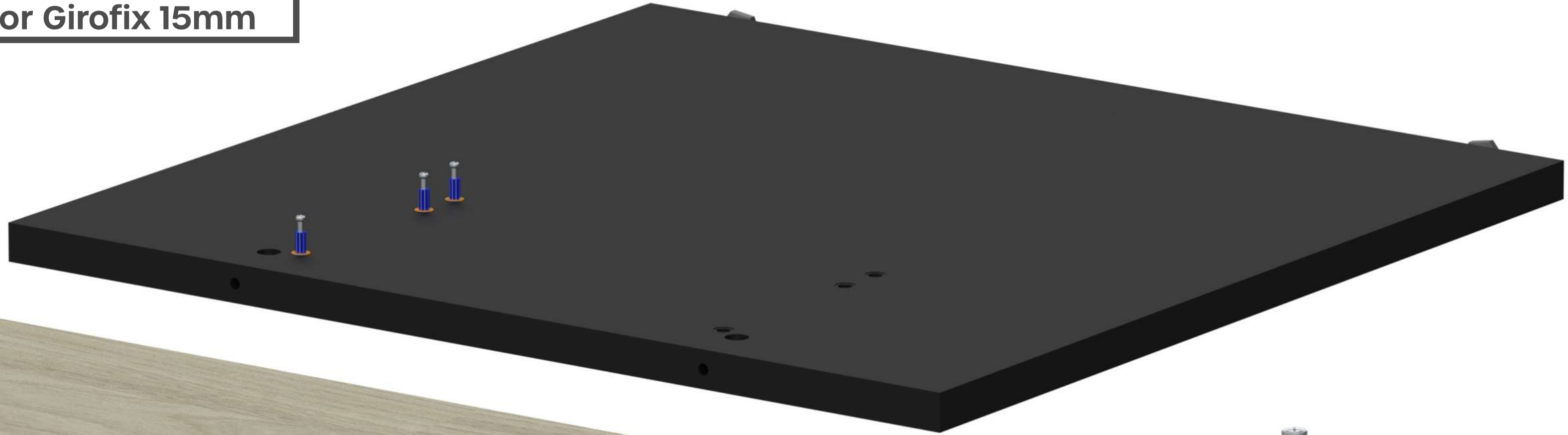



825



02

Parafuso 4x14mm



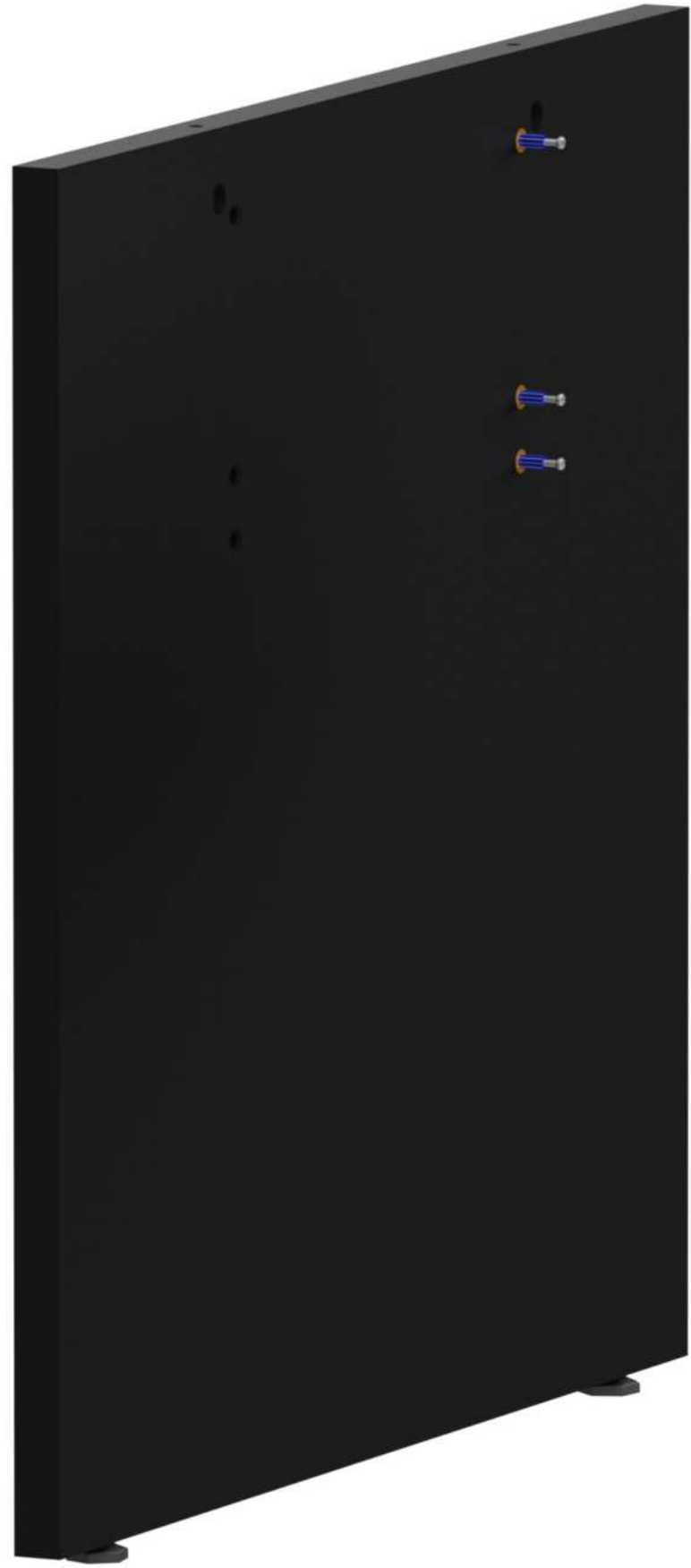

9611

01

Tampo Mesa





710

02

Suporte Plastico 8/10



4839

02

Bucha Americana 1/4



6105

02

Pino Girofix

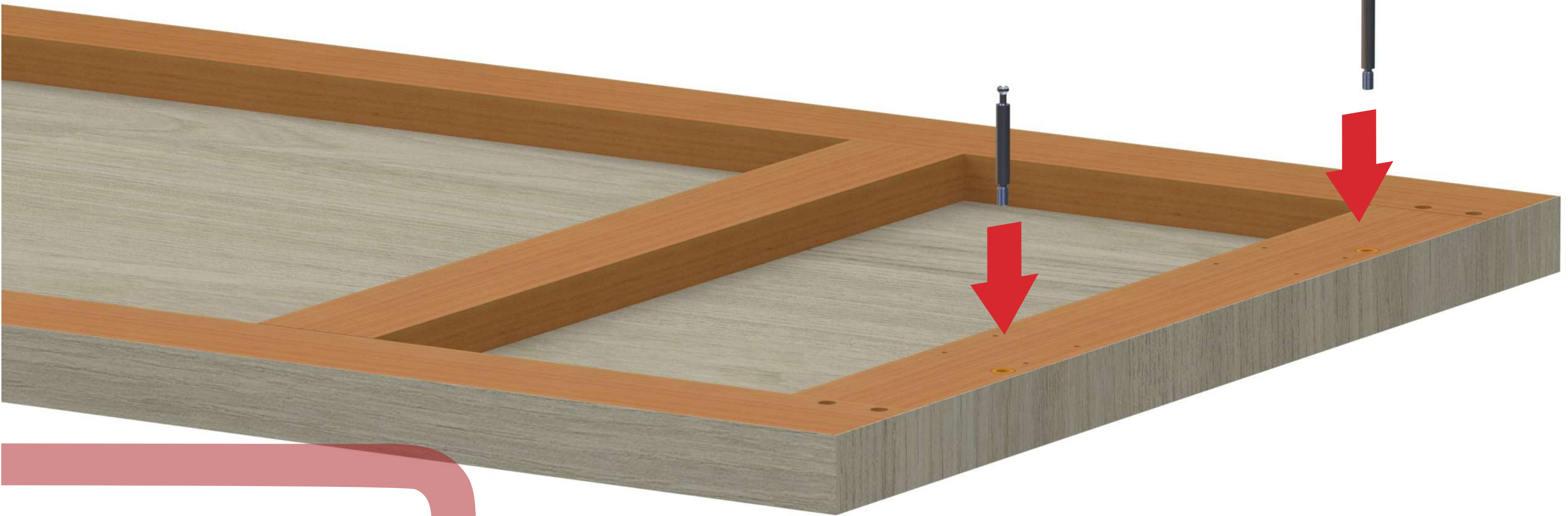

760

02

Espaçador

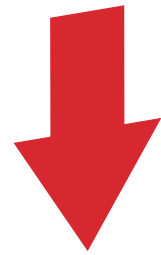





5988



02

Suporte Fixação 14x20

825

04

Parafuso 4x14mm



847



02

Parafuso 1/4x3/4





Instrução de Limpeza

Para produtos em MDF, MDP e MADEIRA (PEÇAS ENVERNIZADAS, TINGIDAS, LAQUEADAS COM PINTURA UV)

- Para a limpeza, utilize uma flanela seca ou pano macio, levemente umedecido com água. Utilize um pano seco em seguida;
- Evite contato com produtos químicos e abrasivos (solventes, thinner, acetona, etc.)

Para produtos METÁLICOS

- Para a limpeza, utilize uma flanela seca ou pano macio, levemente umedecido com água;
- Evite o contato direto com objetos cortantes;
- Evite contato com produtos químicos e abrasivos (solventes, thinner, acetona, etc.)
- Não utilize nenhum tipo de esponja de aço.

Com essas dicas, seus móveis vão estar sempre limpos e vão durar ainda mais!

GARANTIA

1 - Nossos produtos possuem um prazo de garantia de 01 ano para defeitos de fabricação a partir da emissão da Nota Fiscal da fábrica, incluído os 90 dias determinados pelo Código de Defesa do Consumidor.

2 - O prazo para troca de produtos avariados parcialmente ou inteiro, referente às peças de acabamentos sujeitas ao desgaste natural, ficarão restritas ao prazo legal de 90 dias a partir da emissão da Nota Fiscal.

3 - A empresa somente fará a reposição de partes e componentes dos produtos nos termos discriminados abaixo e que comprovarem a existência do alegado defeito de material ou fabricação.

4 - A garantia é válida para defeitos de fabricação detectados por via e-mail, pelo site ou pela Central de Atendimento (telefone na Etiqueta) e toma-se nula quando:

- Problemas ocorridos por montagem em desacordo com o manual de instrução ou relacionados a adaptações ou alterações realizadas no produto;

- Defeitos e desgaste no acabamento, partes e/ou peças ocorridos por uso intenso ou exposição a condições adversas e não previstas, tais como umidade excessiva, intempéries, maresia, frio e calor intensos, cupim e pragas de madeira em geral, sinistros, acidentes, quedas ou agentes da natureza;

- Problemas ocorridos devido as condições inadequadas do local de instalação do produto, tais como pisos desnivelados, paredes pouco resistentes e fora do prumo, etc;

- Danos causados por serviços ou consertos contratados pelo consumidor, descuido, maus tratos, limpeza e/ou manutenção em desacordo com as instruções contidas no manual;

5 - Todas as reclamações e defeitos observados durante o prazo da garantia serão atendidos mediante a apresentação da nota fiscal de compra e entrando em contato com nossa central de atendimento.

6 - A empresa reserva-se o direito de alterar as característica gerais, técnica e estética, introduzir melhoramentos a sua linha de produtos em qualquer momento, sem incorrer na obrigação de efetuar o mesmo nos produtos em estoque ou já vendidos.

7 - Em caso de troca total do produto ou de peças, a empresa efetuará o envio do mesmo após comprovação da empresa.

A PANDIN está nas REDES SOCIAIS!

Clique nos ícones:



/pandinofficial



@pandinmoveis



WhatsApp SAC



PandinOfficial



Pandin Soluções
em Ambientes

www.pandin.com.br

Pandin