

# CO9103 - PANELEIRO

Manual de Montagem  
Assembly Instructions  
Instrucción de Montaje

decibal<sup>®</sup>  
móveis

Produto Montado  
Producto final  
Assembled

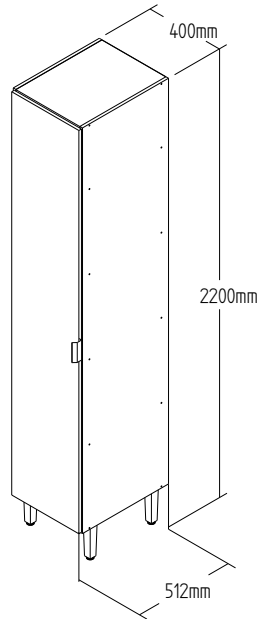

01°

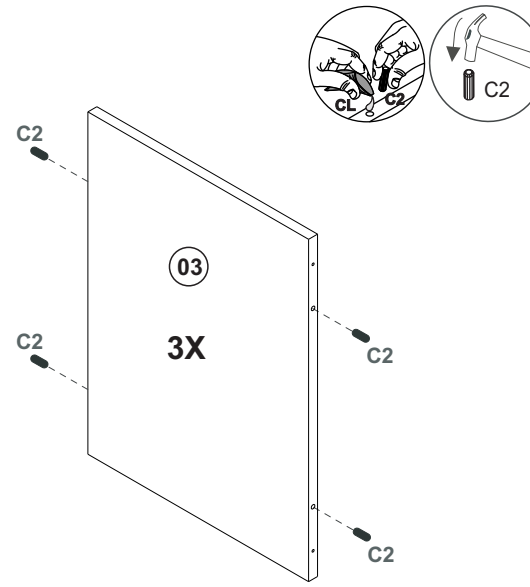

02°

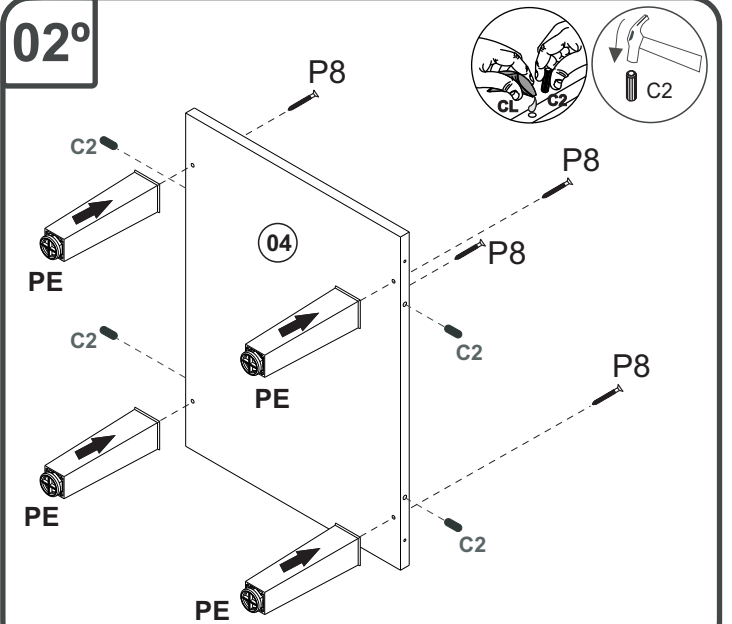

03°

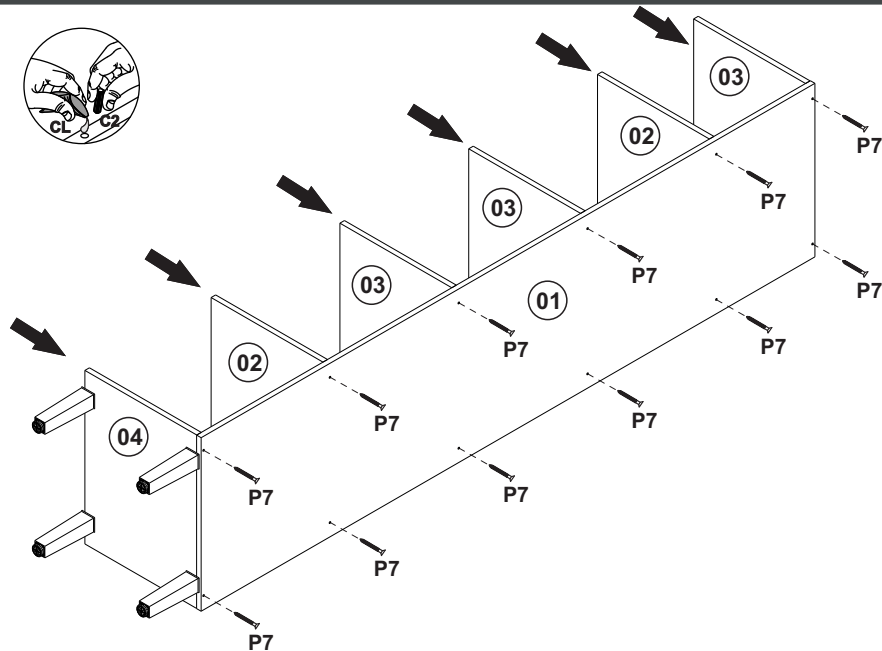

04°

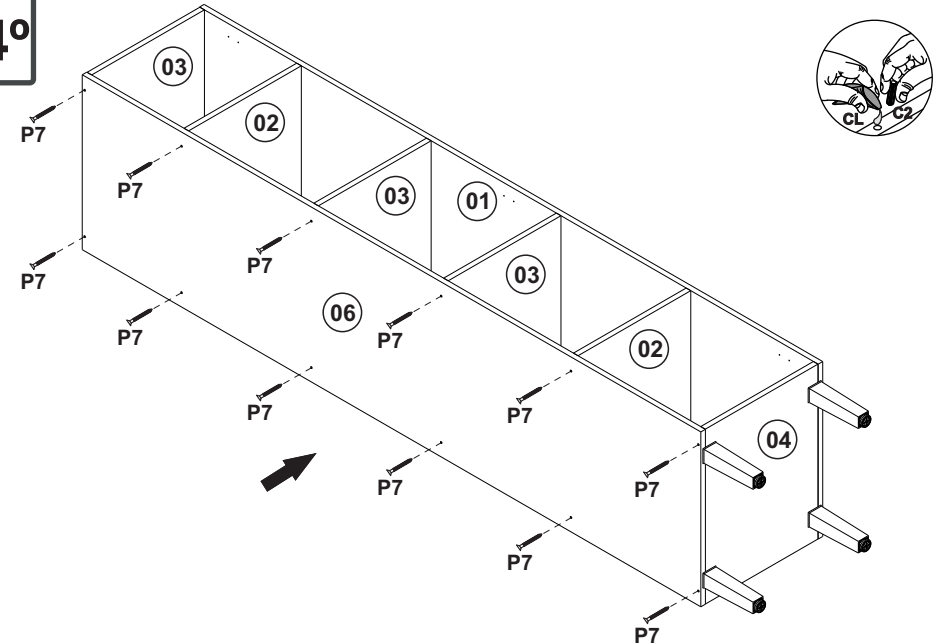

# CO9103 - PANELEIRO

Manual de Montagem  
Assembly Instructions  
Instrucción de Montaje



05°

COSTA/REVÉS/BACK

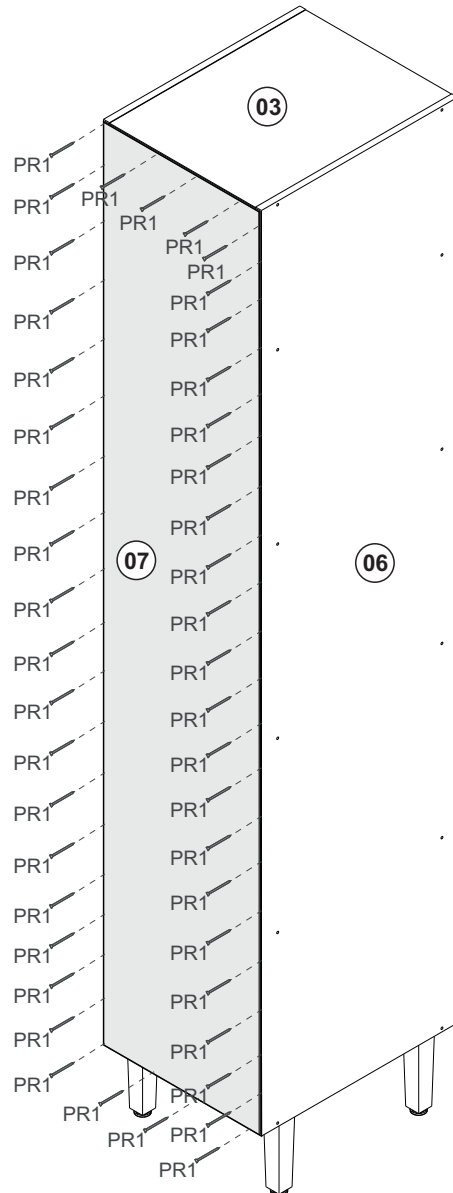
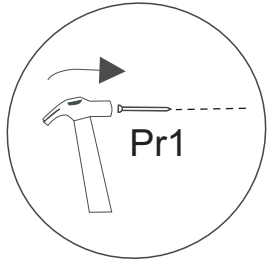

06°

PESO SUPORTADO/PESO SOPORTADO/ WEIGHT SUPPORTED



# CO9103 - PANELEIRO

Manual de Montagem  
Assembly Instructions  
Instrucción de Montaje

**decibal**<sup>®</sup>  
móveis

7°

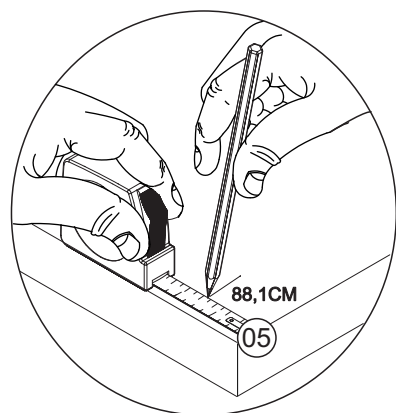
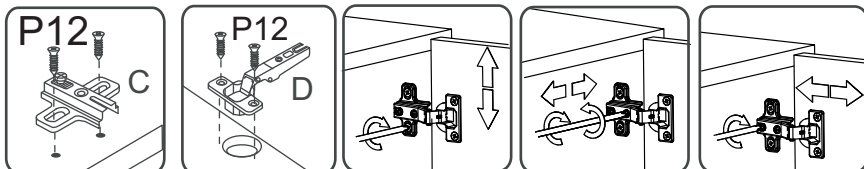

**ATENÇÃO!!!!**





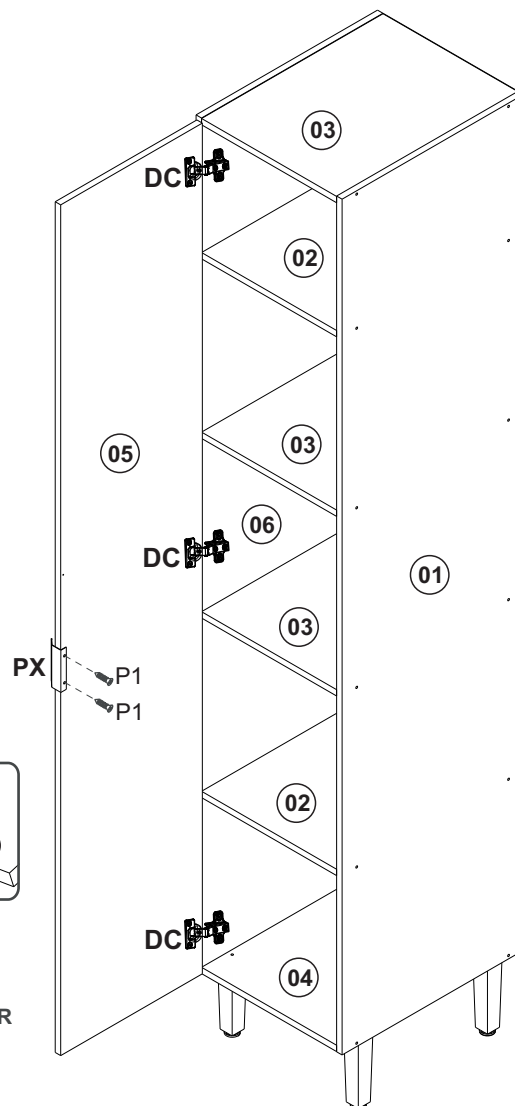

MARCAÇÃO PRA O PRIMEIRO FURO DO PUXADOR

MARCADO PARA EL PRIMER AGUJERO

MARKING FOR THE FIRST HANDLE HOLE

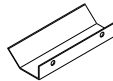

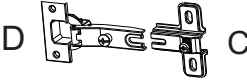
escala (N/A)

LEGENDA	DESCRIÇÃO/DESCRIPCIÓN/DESCRIPTION	CÓDIGO	QUANT.
CL	 COLA/PEGAMENTO/GLUE	01213	01
ET	 ETIQUETA LOGO DECIBAL/LABEL DECIBAL	01312	01
AD	 ADESIVO/ADHESIVO/ADHESIVE	(GRISEO)11895 WOOD 09929	25
PX	 PUXADOR/PEGADOR /HANDLE (MOV410 /100MM)	11440	01
BT	 BATENTE/BATIENTE DE SILICONA/SILICONE STOP 8MM	02921	02
DC	 DOBRADIÇA/BISAGRA/HINGE D=35mm C=0	09449	03
PE	 PÉ/PATA/FOOT (170MM)	11121	04

## Ferragens/ Herrerajes/ Hardware escala (1:1)

LEGENDA	DESCRIÇÃO/DESCRIPCIÓN/DESCRIPTION	CÓDIGO	QUANT.
<b>P7</b>	 PARAFUSO/TORNILLO/SCREW 4X45	01318	<b>24</b>
<b>PR1</b>	 PREGO/CLAVO/NAIL 10X10	01330	<b>60</b>
<b>C2</b>	 CAVILHA/TARUGO/DOWEL 6X30 MM	01211	<b>17</b>
<b>P12</b>	 PARAFUSO/TORNILLO/SCREW 3,5X13 CABEÇA FLANGEADA	09927	<b>12</b>
<b>P1</b>	 PARAFUSO/TORNILLO/SCREW 3,5X12	01328	<b>02</b>
<b>P8</b>	 PARAFUSO/TORNILLO/SCREW 5X45	01320	<b>04</b>
<b>PU</b>	 PARAFUSO UNIÃO/UNIÓN DETORNILLO /SCREW UNION	01495	<b>02</b>

## Relação de Peças/ Relación de Piezas/Parts List

Nº	CÓDIGO/ CODE	DESCRIÇÃO/DESCRIPCIÓN/DESCRIPTION	QTD/ CANT	VOL.
1	0548820	LATERAL DIR/LATERAL/SIDE 2030X497X15MM	1,00	1
2	0549156	PRATELEIRA/ESTANTE/SHELF 497X370X15MM	2,00	1
3	0548819	BASE 497X370X15MM	3,00	1
4	0548663	BASE INF 497X370X15MM	1,00	1
5	0548823	PORTA/ PUERTA/ DOOR 2018X388X15MM	1,00	1
6	0548821	LATERAL ESQ/LATERAL/SIDE 2030X497X15MM	1,00	1
7	0548822	COSTA/REVÉS/BACK 2124X394X2,8MM	2,00	2

**ATENÇÃO!!!! montadores e consumidores**  
\* Ajustar o torque da parafusadeira para não danificar as peças escareando o parafuso \*

**ATENCIÓN!!!! montadores e consumidores**  
\* Ajuste el torque del destornillador para no dañar las piezas avallanando el tornillo \*

**ATTENTION!!!! assemblers and consumers**  
\* Adjust the torque of the screwdriver so as not to damage the parts by countersinking the screw \*

Ferramenta necessária  
Necessary tools  
Herramientas necesarias



**ATENÇÃO!!!! montadores e consumidores**  
\* Para limpar o móveis utilize somente um pano úmido (umedecido em água pura ou água com sabão neutro). Depois, passe um pano seco. Evite a umidade excessiva.  
\* Evite usar álcool, água sanitária, detergente e outros produtos químicos, mesmo diluídos em água. Não utilize produtos abrasivos de nenhuma espécie

**ATENCIÓN!!!! montadores e consumidores**  
\* Para limpiar el mueble utilice solamente un paño húmedo (humedecido con agua limpia o con un jabón suave). A continuación, utilice un paño seco. Evite el exceso de humedad.  
\* Evite uso de alcohol, hipoclorido solución basada, detergente y otros productos químicos, mismo diluídos en agua. No utilice productos abrasivos de ningún tipo.  
**ATTENTION!!!! assemblers and consumers**  
\* To clean the furniture, use only a damp cloth (humidify it only in pure water ou water and neutral soap). After, use a dry cloth. Avoid excessive humidity.  
\* Avoid using alcohol, bleach, detergent and other chemical products, even diluted in water. Do not use any kind of abrasive cleaning agents to clean the furniture.  
The use of such products may jeopardize the ?nal characteristics of the furniture.

 60 min.
  1 montador  
1 ajustador  
1 Fitter

[www.decibal.com.br](http://www.decibal.com.br)

