

CO9201 - AÉREO 0,60M

Manual de Montagem
Assembly Instructions
Instrucción de Montaje

decibal[®]
móveis

Produto Montado
Producto final
Assembled

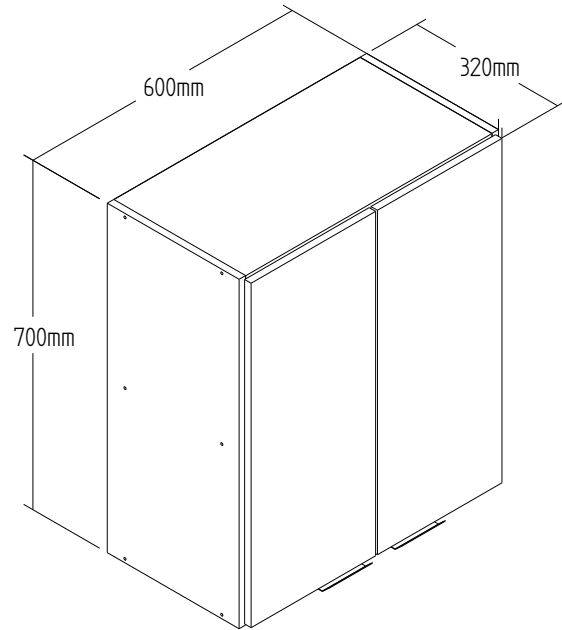

1º

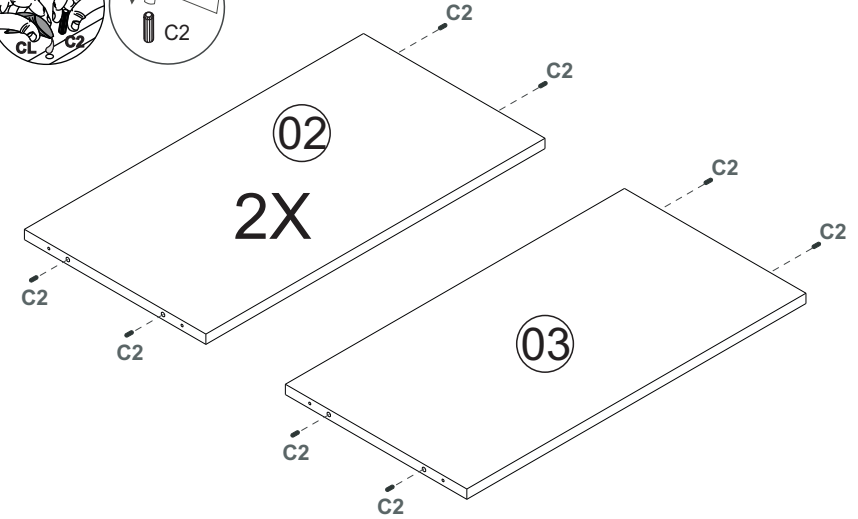
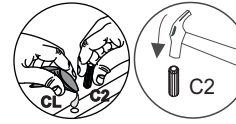

2º

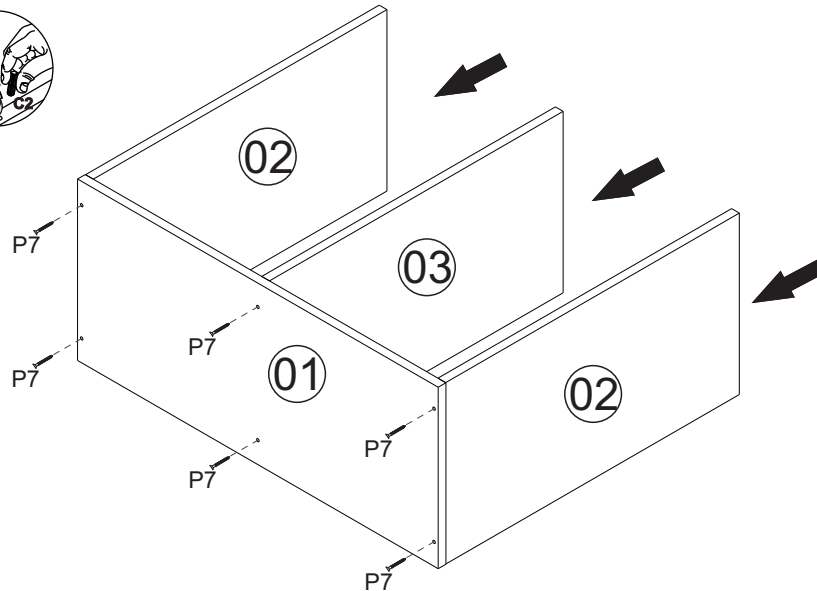

3º

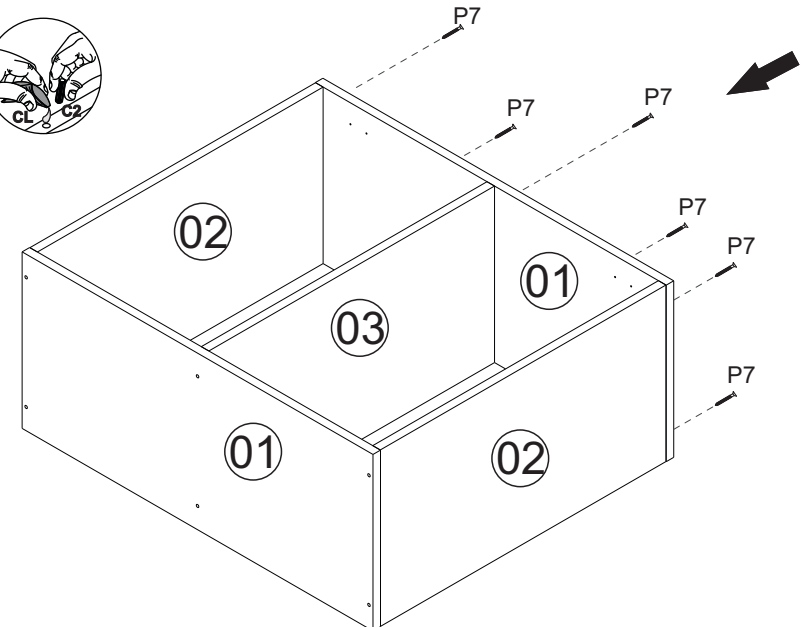

CO9201 - AÉREO 0,60M

Manual de Montagem
Assembly Instructions
Instrucción de Montaje

decibal[®]
móveis

4º COSTA/REVÉS/BACK

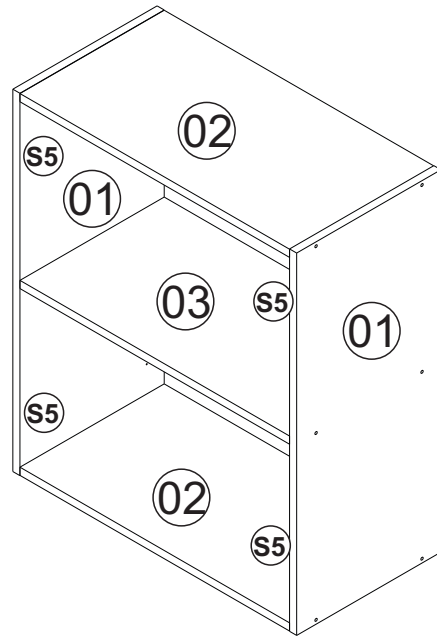
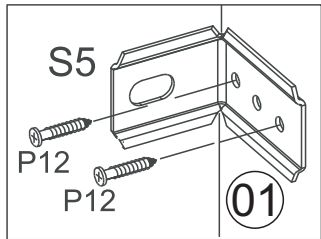

Fixação parede

Fixed in the wall

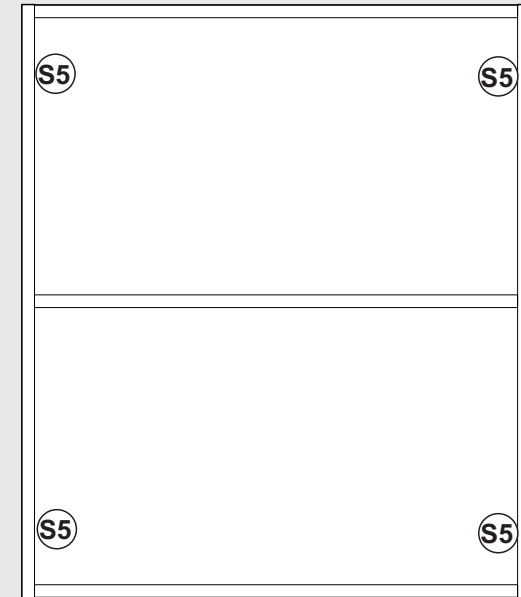
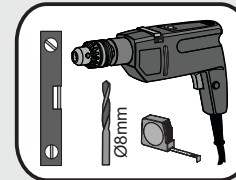
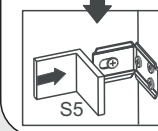
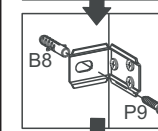
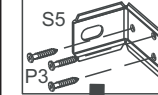

5º COSTA/REVÉS/BACK

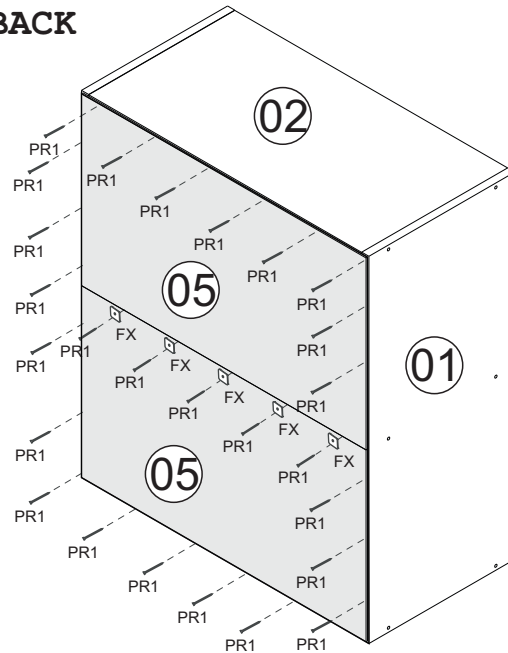
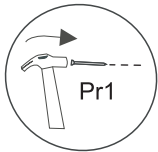

PESO SUPORTADO/PESO SOPORTADO/ WEIGHT SUPPORTED

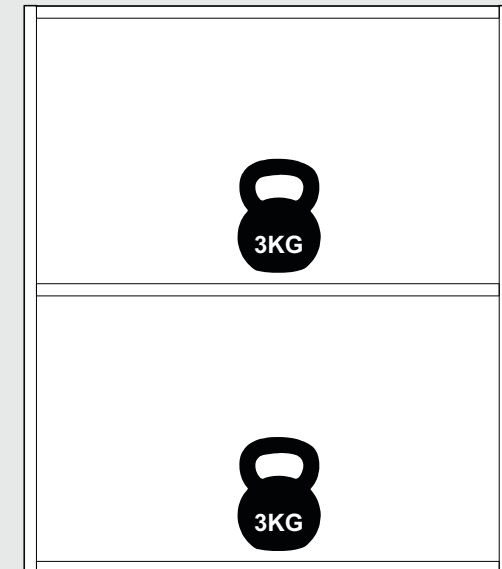

CO9201 - AÉREO 0,60M

Manual de Montagem
Assembly Instructions
Instrucción de Montaje

decibal[®]
móveis

6°

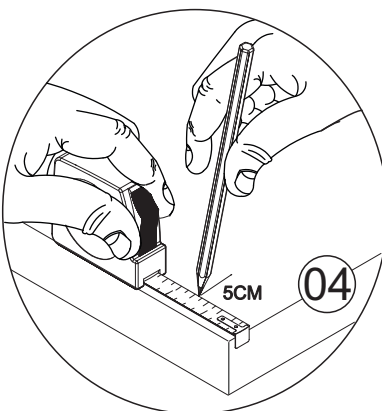
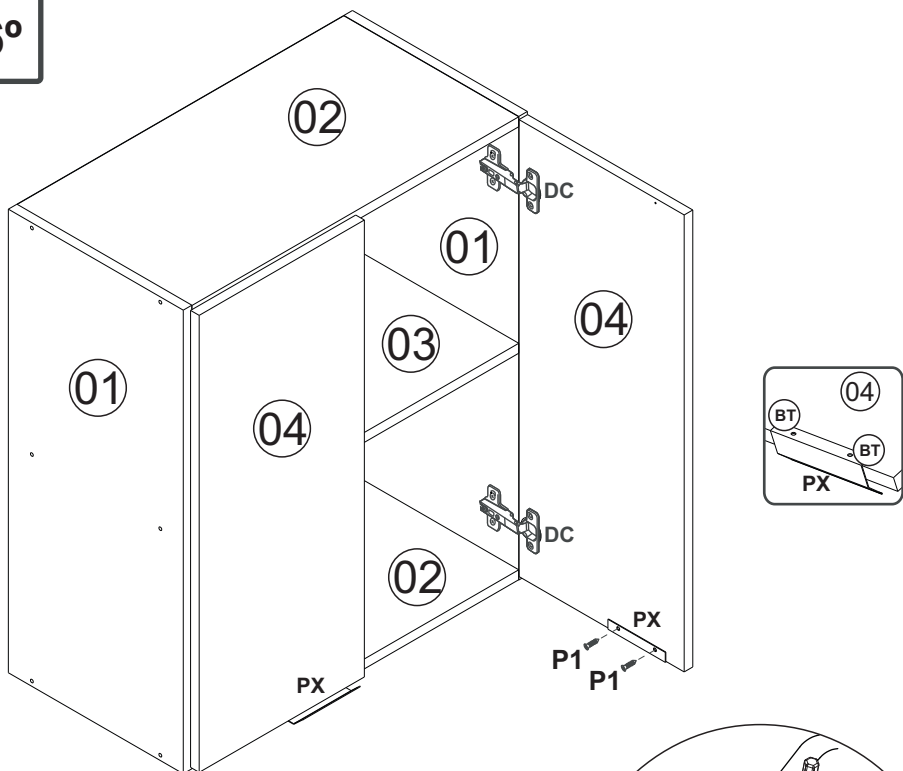

ATENÇÃO!!!!

MARCAÇÃO PRA O PRIMEIRO FURO DO PUXADOR

MARCADO PARA EL PRIMER AGUJERO

MARKING FOR THE FIRST HANDLE HOLE

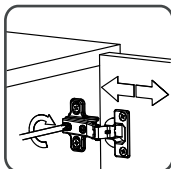
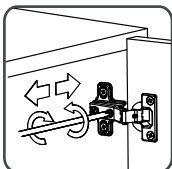
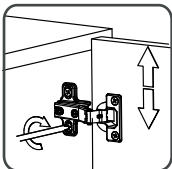
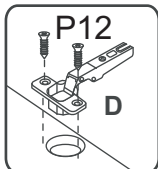
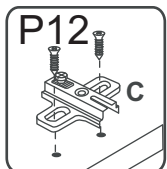

Relação de Peças/ Relación de Piezas/Parts List

N°	CÓDIGO/CODE	DESCRIÇÃO/DESCRIPCIÓN/DESCRIPTION	QTD/CANT	VOL.	
1	0549154	LATERAL/LATERAL/SIDE	700X305X15MM	2	1
2	0549153	BASE	570X305X15MM	2	1
3	0549157	PRATELEIRA/ESTANTE/SHELF	570X305X15MM	1	1
4	0549158	PORTA/PUERTA/DOOR	690X288X15MM	1	1
5	0549159	COSTA/REVÉS/BACK	598X348X2, 8MM	2	1

www.decibal.com.br

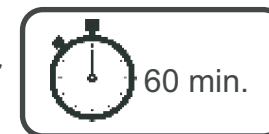

Ferramenta necessárias
Necessary tools
Herramientas necesarias

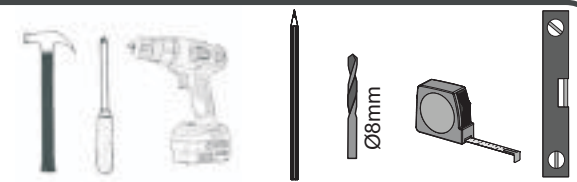

ATENÇÃO!!!! montadores e consumidores

* Para limpar o móveis utilize somente um pano úmido (umedecido em água pura ou água com sabão neutro). Depois, passe um pano seco. Evite a umidade excessiva.

* Evite usar álcool, água sanitária, detergente e outros produtos químicos, mesmo diluídos em água. Não utilize produtos abrasivos de nenhuma espécie

ATENCIÓN!!!! montadores e consumidores

* Para limpiar el mueble utilice solamente un paño húmedo (humedecido con agua limpia o con un jabón suave).

Continuación, utilice un paño seco. Evite el exceso de humedad.

* Evite uso de alcohol, hipoclorídoro solución basada, detergente y otros productos químicos, mismo diluidos en agua. No utilice productos abrasivos de ningún tipo.

ATTENTION!!!! assemblers and consumers







* To clean the furniture, use only a damp cloth (humidify it only in pure water ou water and neutral soap).After, use a dry cloth.Avoid excessive humidity.

*Avoid using alcohol, bleach, detergent and other chemical products, even diluted in water. Do not use any kind of abrasive









cleaning agents to clean the furniture.

The use of such products may jeopardize the ?nal characteristics of the furniture.

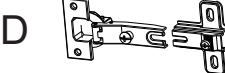
Ferragens/ Herrajes/ Hardware

		escala (1:1)	
LEGENDA	DESCRIÇÃO/DESCRIPCIÓN/DESCRIPTION	CÓDIGO	QUANT.
P7	 PARAFUSO/TORNILLO/SCREW 4X45	01318	12
PR1	 PREGO/CLAVO/NAIL 10X10	01330	40
C2	 CAVILHA/TARUGO/DOWEL 6X30 MM	01211	13
P1	 PARAFUSO/TORNILLO/SCREW 3,5X12	01328	04
PU	 PARAFUSO UNIÃO/UNIÓN DETORNILLO /SCREW UNION	01495	02
P12	 PARAFUSO/TORNILLO/SCREW 3,5X13	09927	24
P9	 PARAFUSO/TORNILLO/SCREW 6X50	03827	04

escala (N/A)

LEGENDA	DESCRIÇÃO/DESCRIPCIÓN/DESCRIPTION	CÓDIGO	QUANT.
CL	 COLA/PEGAMENTO/GLUE	01213	01
ET	 ETIQUETA LOGO DECIBAL/LABEL DECIBAL	01312	01
B1	 BUCHA/BUJE/BUCHING (8mm)	01311	04
DC	 DOBRADIÇA/BISAGRA/HINGE D=35mm C=0mm	09449	04
S5	 SUPORTE AÉREO/APOYO AÉREO/AIR SUPPORT	03828 EBANO 04501	04
FX	 FIXADOR COSTA/FIJADOR FONDO/FIXER COAST	01331	07
AD	ADESIVO/ADHESIVO/ADHESIVE 	NATURALLE 09963 WOOD 09929	08
BT	 BATENTE/BATIENTE DE SILICONA/SILICONE STOP 8MM	02921	04
PX	 PUXADOR/PEGADOR /HANDLE (MOV410 /100MM)	11440	02

ATENÇÃO!!!! montadores e consumidores
* Ajustar o torque da parafusadeira para não danificar as peças escareando o parafuso *

ATENCIÓN!!!! montadores e consumidores
* Ajuste el torque del destornillador para no dañar las piezas avallanando el tornillo *

ATTENTION!!!! assemblers and consumers
* Adjust the torque of the screwdriver so as not to damage the parts by countersinking the screw *

Medida em mm

