

**ATENÇÃO/ ATENCION/ ATTENTION**

DIMENSÕES DO PRODUTO / PRODUPT DIMENSIONS / DIMENSIONS PRODUCT - **WxDxH / LxDxA - 1226 X 482 X 1821 MM**

ESTE PRODUTO NÃO PODE SER ARRASTADO.  
THIS PRODUCT MUSTNOT BE DRAGGED.  
ESTE PRODUCTO NO SE PUEDE ARRASTRAR

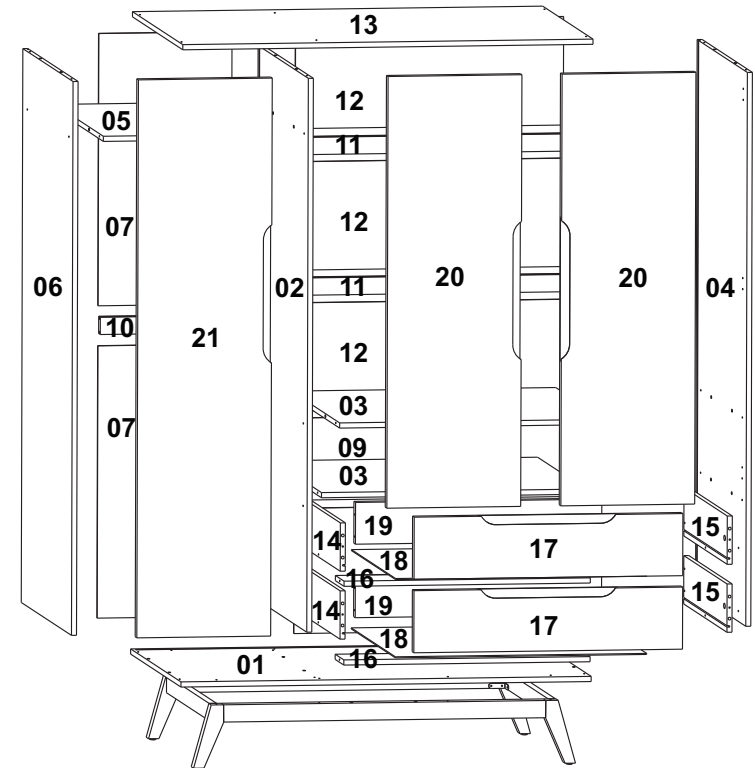
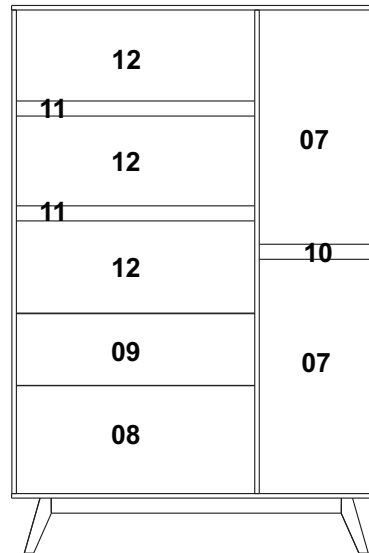
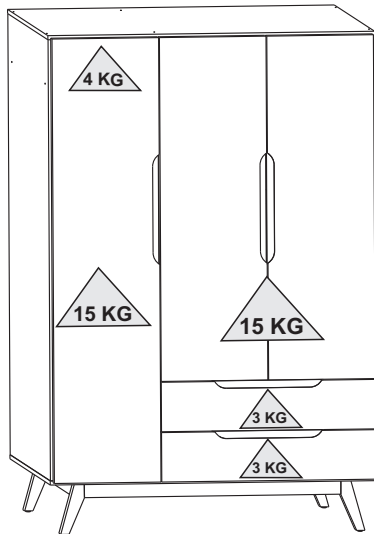

**ATENÇÃO / ATTENTION / ATENCION**

Nunca utilizar óleos, lustra móveis, produtos abrasivos, saponáceos, esponja de aço e outros.

Never use oils, furniture polish, abrasive products, soaps, steel sponge and others.

Nunca use aceites, pulimentos, abrasivos, jabones, esponja de acero y otros.

**CUIDADOS ESPECIAIS/ SPECIAL CARE/ CUIDADOS ESPECIALES**

- Evitar expor o móvel ao sol, e em lugares úmidos.
- Limpar com flanela seca ou com pano levemente umedecido em água.
- Avoid exposing the furniture to the sun, and in damp places.
- Clean with dry flannel or lightly cloth moistened with water.
- Evite exponer los muebles al sol y en lugares húmedos.
- Limpiar con flanela seca o un paño ligero, humedecido con agua.

**MONTAR O PRODUTO SOBRE A EMBALAGEM, EVITANDO DANOS NA PINTURA. ACONSELHAMOS QUE A MONTAGEM DO PRODUTO SEJA POR UM PROFISSIONAL.**

**SETUP THE PRODUCT ON TOP OF THE PACKAGING, AVOIDING DAMAGE TO THE PAINT. WE RECOMMEND THAT THE INSTALLATION IS DONE BY A PROFESSIONAL.**

**MONTAR EL PRODUCTO EN EL PAQUETE, EVITAR LESIONES EN PINTURA. AVISAMOS QUE EL MONTAJE DEL PRODUCTO SEA UN PROFESIONAL.**

MONTAR O PRODUTO SOBRE A EMBALAGEM, EVITANDO DANOS NA PINTURA. ACONSELHAMOS QUE A MONTAGEM DO PRODUTO SEJA POR UM PROFISSIONAL.



Ferramentas necessárias / Necessary tools / Herramientas Necesarias  
(não fornecidas) (not provided) (No proporcionadas)

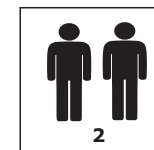

**MEDIDA UTILIZADA EM MM / UNIT MEASURE USED IS MILLIMETERS (MM)**

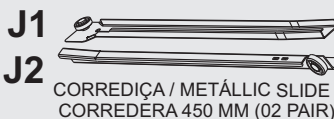
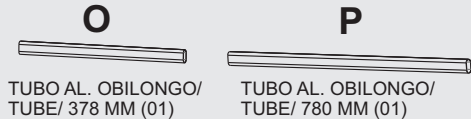
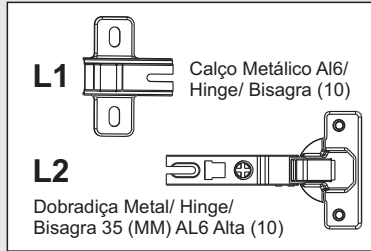
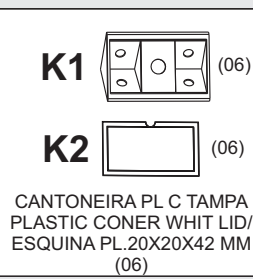
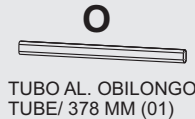
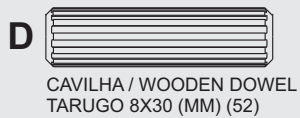
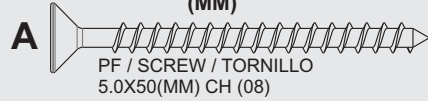

**Kit Anti Tombamento/ Anti Tipping Kit Kit para no Caer**

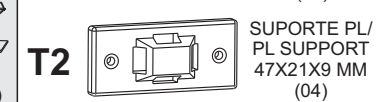
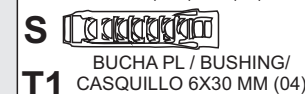
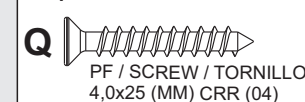

ITEM		DESCRIÇÃO DA PEÇAS / DESCRIPTION OF PARTS / UNIT MEASURE USED IS MILLIMETERS (MM)					CORES/ COLORS/ COLORES			
COD. CODE	Nº	NOME/NAME/NOMBRE	MEDIDAS / MEASURES (MM)	TIPO TYPE	QUANT AMOUNT CANTIDAD	CONHAQUE	BRANCO WHITE BLANCO	OFF WHITE	PRETO BACK NEGRO	
16782	1	BASE	1226X465X15	MDP	01	01/02	01/05		01/07	
16776	2	DIVISOR / DIVIDER/ DIVISOR	1605X465X15	MDP	01	02/02	02/05		02/07	
16778	3	PRATELEIRA INFERIOR/ BOTTOM SHELF/ ESTANTE INFERIOR	791X450X15	MDP	02	03/02	03/05		03/07	
16779	4	LATERAL DIREITA/ RIGHT SIDE/ LADO DERECHO	1605X465X15	MDP	01	04/02	04/05		04/07	
16777	5	PRATELEIRA/ SHELF/ ESTANTE	450X388X15	MDP	01	05/02	05/05		05/07	
16780	6	LATERAL ESQUERDA/ LEFT SIDE/ LADO IZQUIERDO	1605X465X15	MDP	01	06/02	06/05		06/07	
16793	7	FUNDO TRÁS / BACK / TRASEIRO	796X398X3	MDF	02		07/05		07/07	
16795	8	FUNDO TRÁS / BACK / TRASEIRO	801X362X3	MDF	01		08/05		08/07	
16794	9	FUNDO TRÁS / BACK / TRASEIRO	801X239X3	MDF	01		09/05		09/07	
16791	10	REFORÇO TRÁS ESQUERDO/ LEFT REINFORCEMENT BACK / TRASERO IZQUIERDO	388X50X15	MDF	01		10/05		10/07	
16790	11	REFORÇO TRÁS DIREITO/ RIGHT REINFORCEMENT BACK/ TRASERO DERECHO	791X50X15	MDF	02		11/05		11/07	
16792	12	FUNDO TRÁS / BACK / TRASEIRO	801X318X3	MDF	03		12/05		12/07	
16781	13	TAMPO/ TOP	1226X465X15	MDP	01	13/02	13/05		13/07	
16784	14	LATERAL GAV. ESQ/ LEFT DRAWER SIDE/ LADO CAJÓN IZQUIERDO	400X140X15	MDP	02		14/05	14/06	14/07	
16785	15	LATERAL GAV. DIR/ LEFT DRAWER SIDE/ LADO CAJÓN DERECHO	400X140X15	MDP	02		15/05	15/06	15/07	
16787	16	REFORÇO GAVETA/ DRAWER REINFORCEMENT/ REFUERZO CAJÓN	736X80X15	MDP	02					
16783	17	FRENTE GAVETA/ DRAWER FRONT/ CAJÓN DELANTERO	805X179X15	MDF	02		17/05	17/06	17/07	
16796	18	FUNDO GAVETA/ DRAWER BACK/ FONDO DEL CAJÓN	753X408X3	MDF	02		18/05		18/07	
16786	19	CONTRA FRENTE/ AGAINST DRAWER FRONT/CONTRA EL FRENTE DEL CAJÓN	736X121X15	MDP	02		19/05	19/06	19/07	
16789	20	PORTA CENTRAL/ CENTRAL DOOR/ PUERTA CENTRAL	1260X401X15	MDF	02		20/05	20/06	20/07	
16788	21	PORTA ESQUERDA/ LEFT DOOR/ PUERTA IZQUIERDA	1626X401X15	MDF	01		21/05	21/06	21/07	
15704	A	PF / Screw / Tornillo 5,0x50 CH			08					
438	B	Parafuso / Screw / Tornillo 4,0x40(MM) CH			50					
986	C	Parafuso / Screw / Tornillo 3,5x14(MM) CH			140					
137	D	Cavilha / Wooden Dowel / Tarugo 8x30(MM)			52					
532	E	Pino Minifix /Minifix Screw 32(MM)			04					
508	F	Tambor Minifix / Minifix Round Nut 15(MM)			04					
17498	I	Cantoneira Metal/ Metal corner/ Esquina del metal 60X60X2 MM			04					
12176	J	Corred./Metallic Slid/ Corredera/ 400 MM (02 PAIR)			02					
15175	K	Cantoneira PL/Plast. corner with lid / Esquina PL. 20X20X42(MM)			06		CINZA	CINZA	CINZA	
17209	L1	Calço Metálico AL6 0MM/ Hinge/ Bisagra			10					
17206	L2	Dobradiça Metálica/ Hinge/ Bisagra 35 (MM) AL6 ALTA			10					
341	M	Suporte PL obilongo/Obolongo PL support			04					
9514	N	Fixador de Fundo/ Fixer/ Fijador 14x13x10			18	PRETO	PRETO	PRETO	PRETO	
17196	O	Tubo AL obilongo/ Tube 378x14 MM			01					
17197	P	Tubo AL obilongo/ Tube 780x14 MM			01					

**Dispositivo Anti Tombamento PL/ Anti Tipping Kit/ Kit Para no cair**

434	Q	Parafuso/ Screw/ Tornillo 4,0x25 CH			04				
437	R	Parafuso/ Screw/ Tornillo 4,0x35 CH			04				
16537	S	Bucha PL/ Bushing/ Casquillo 6X30 Sx9 MM			04				
16438	T1	Abraçadeira Nylon/ Nylon Clamp/ Abrazadeira Nylon300 (MM)			02				
	T2	Suport PL./ Plástic Suport/ Suporte Plástico 47X21X9 (MM)			02				
17198	W	Vista Pé Pinus Lateral/ Side Foot View/ Vista Lado del pie- 22X50X394MM			02	MÓGNO	MÓGNO	MÓGNO	MÓGNO
15577	X	Pé Pinus CHASSI-Lado X / Chassis foot-side X / Pie del chasis- lado X-190MM			02	MÓGNO	MÓGNO	MÓGNO	MÓGNO
15578	Y	Pé Pinus CHASSI-Lado Y / Chassis foot-side Y / Pie del chasis-lado Y- 190MM			02	MÓGNO	MÓGNO	MÓGNO	MÓGNO
15571	Z	Vista p/Pé Pinus Frontal/ Front Foot View/ Vista Front del pie-22X50X963MM			02	MÓGNO	MÓGNO	MÓGNO	MÓGNO
		Certif. de Garant./ Warranty Certif.			01				

12897		Tapa F. Adesivo MÓGNO/ MÓGNO Holer Sticker/Pegatina de Agugero MÓGNO 18 mm (GUARDA ROUPA- CONHAQUE/ OFF WHITE)							14
13877	G	Tapa F. Adesivo GELO/ GELO Holer Sticker/Pegatina de Agugero GELO 18 mm (GARDA ROUPA- CONHAQUE/ OFF WHITE)							04
12734		Tapa F. Adesivo BRANCO/ WHITE Holer Sticker/Pegatina de Agugero BLANCO 18 mm (GUARDA ROUPA BRANCO)							12
13363		Tapa F. Adesivo PRETO/ BLACK Holer Sticker/Pegatina de Agugero NEGRO 18 mm (GUARDA ROUPA PRETO)							12
7687	H	Tapa Furo BRANCO / WHITE Holer Sticker/Pegatina de Agugero BLANCO 8 mm (GUARDA ROUPA- BRANCO)							06
952		Tapa Furo PRETO/ BLACK Holer Sticker/Pegatina de Agugero NEGRO 8 mm (GUARDA ROUPA- PRETO)							06

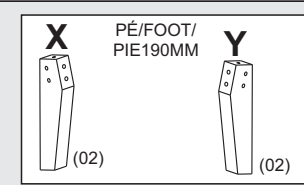
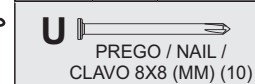

**PREPARAÇÃO DE PEÇAS / PARTS PREPARATION / PREPARACION DE PIEZAS**

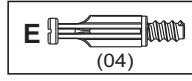
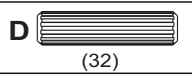
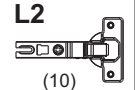
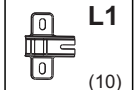
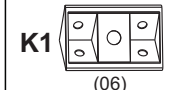

**!** Fixar aqui ou no Passo 12/  
Fix here or in step 12/  
Solicite aqui o en el paso 12.

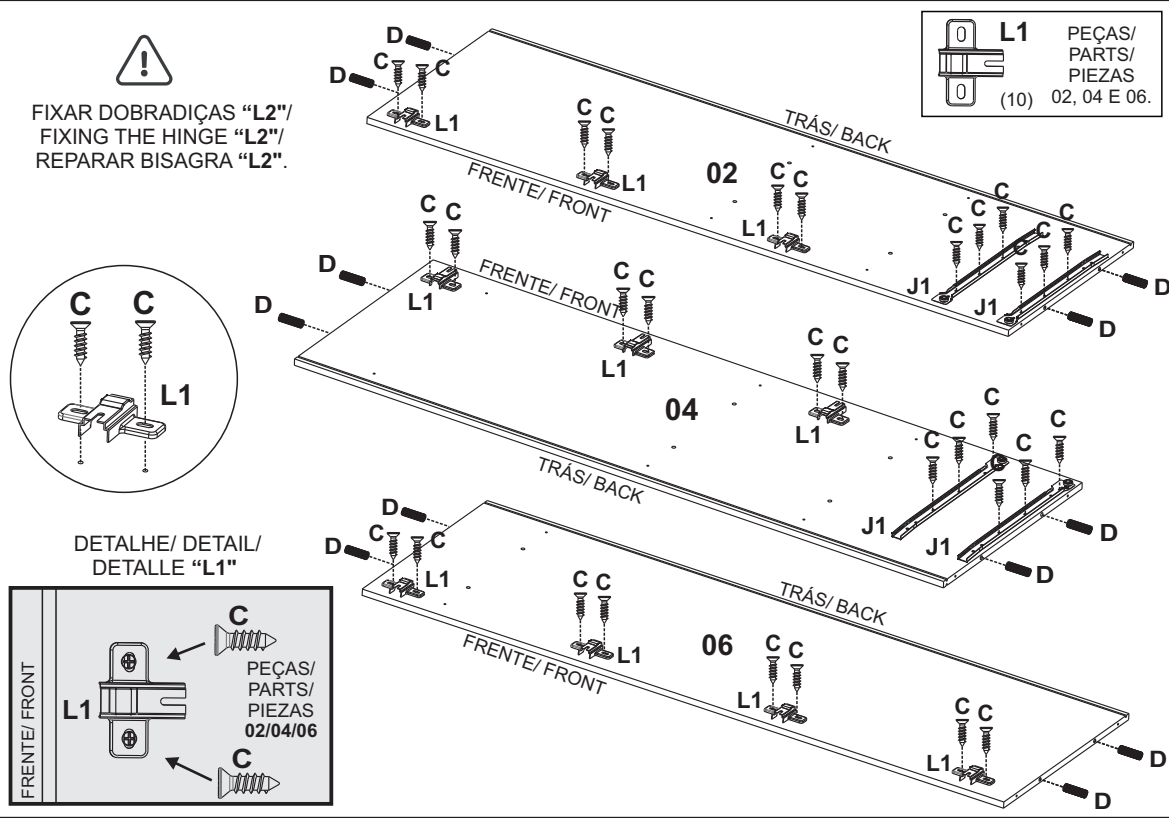
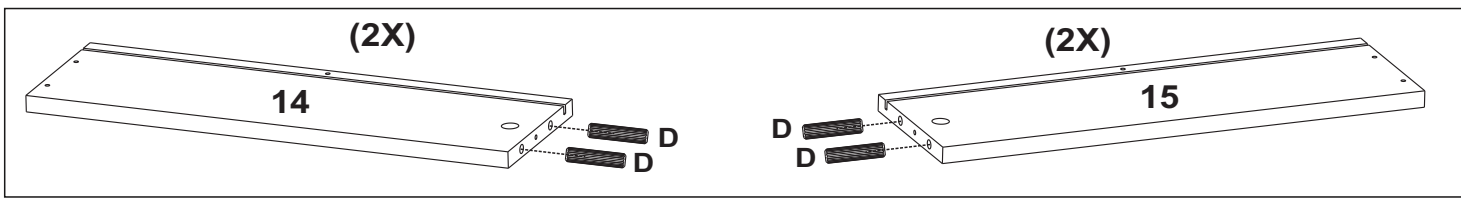
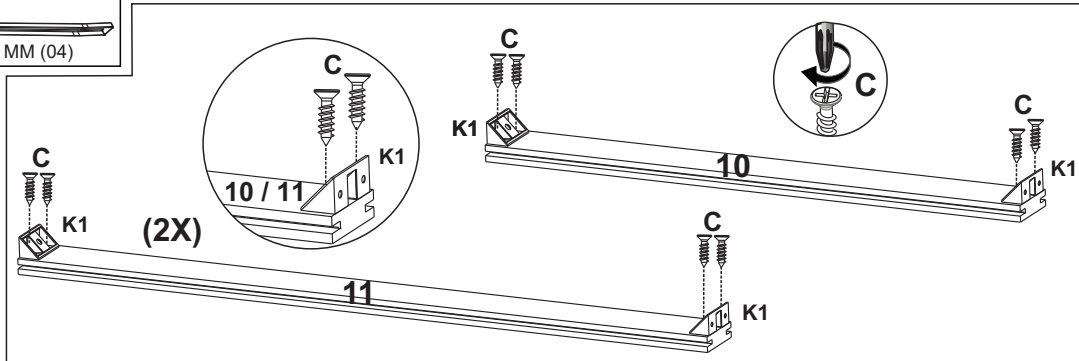
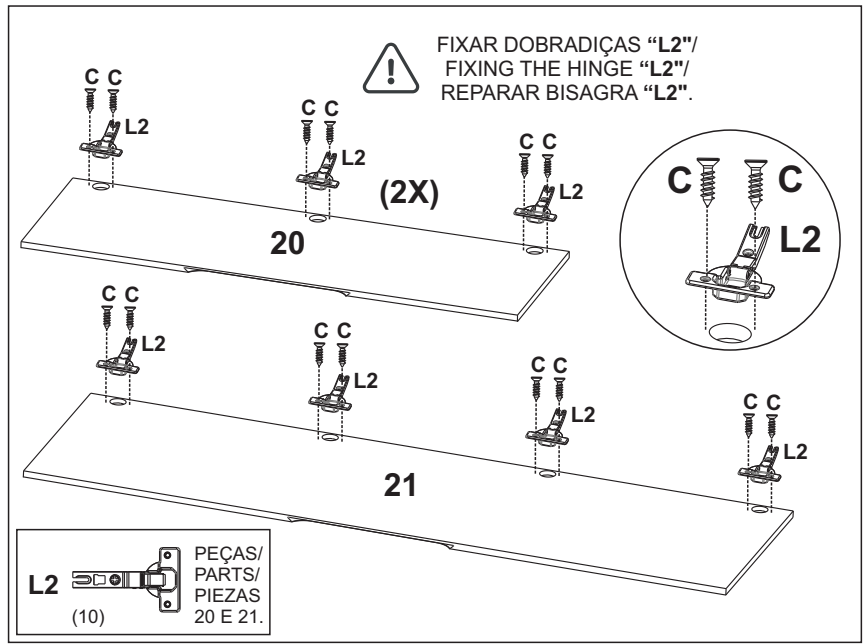
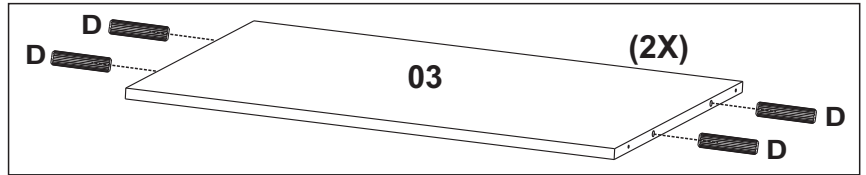
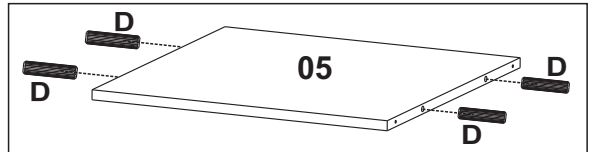
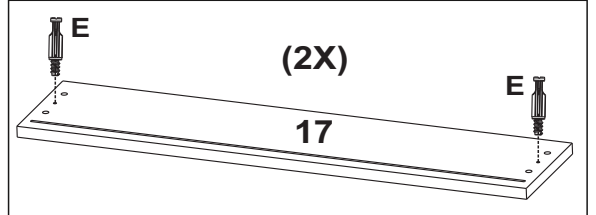
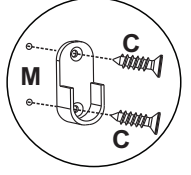

1

1º

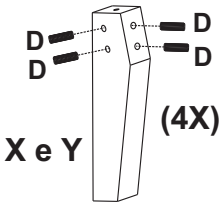

3º

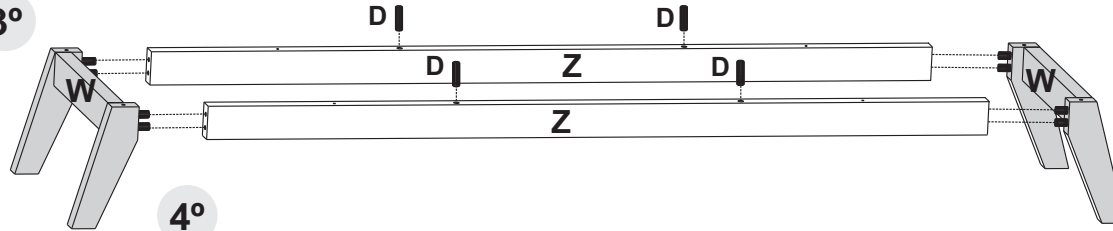

2º

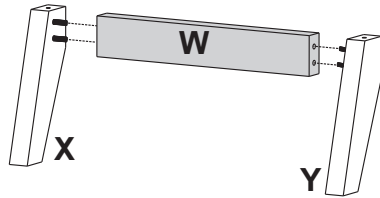

4º

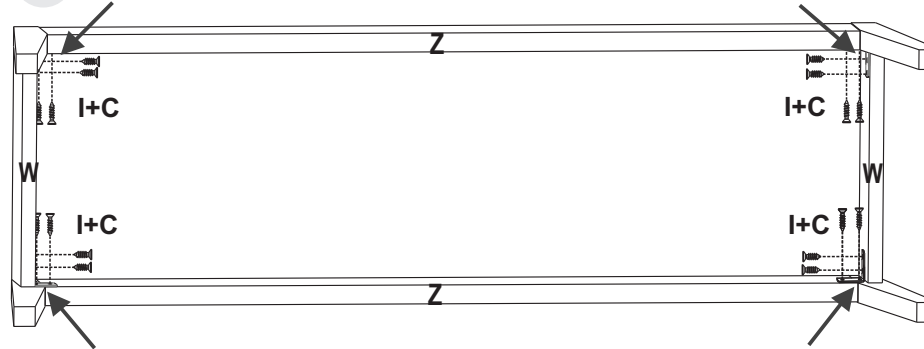

ATENÇÃO/  
ATTENTION / ATENCION

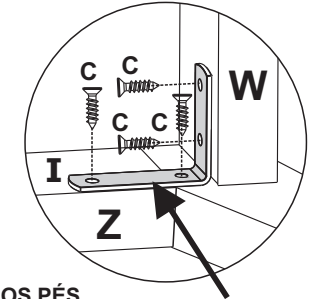

PARAFUSAR NOS PÉS  
SCREW ON FEET  
TORNILLO EN LOS PIES

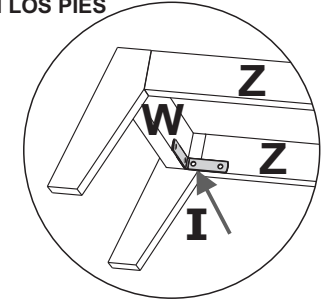

C=16  
D=20  
I=04  
X=02  
Y=02  
W=02  
Z=02

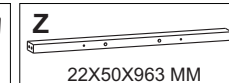
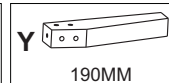
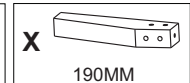
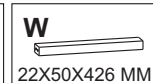
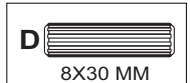
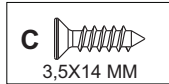

2

Obs: As peças pintadas nos passos são apenas ilustrativas.  
The parts painted in the steps are illustrative only.  
Las partes pintadas en los pasos son solo ilustrativas.

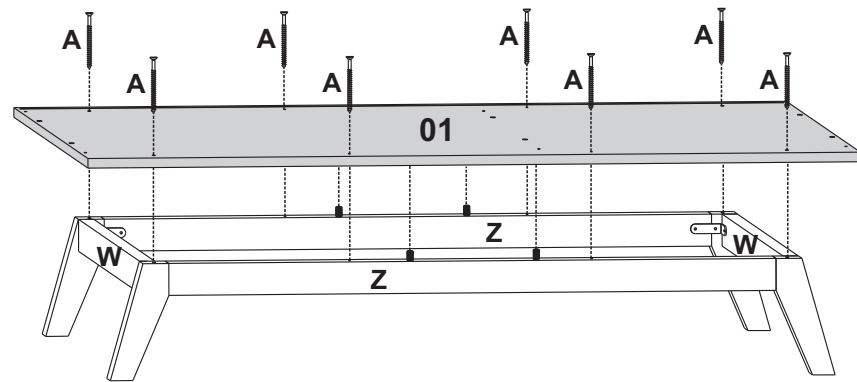
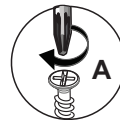

3

ATENÇÃO/  
ATTENTION / ATENCION

Borda Cor/ Color edge/  
Borde de color

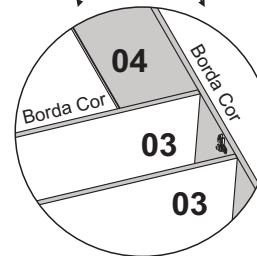

B=08

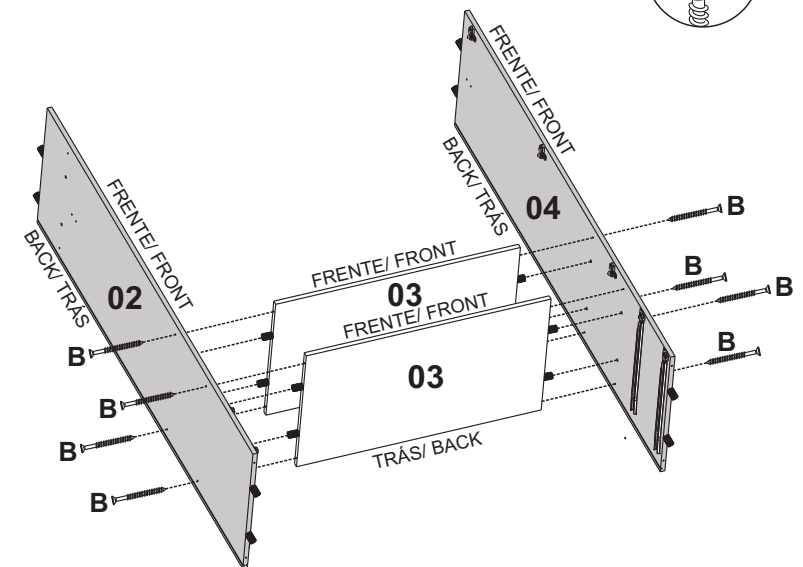
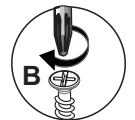
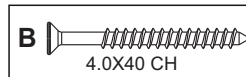

A=08

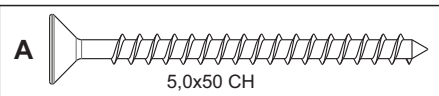

4

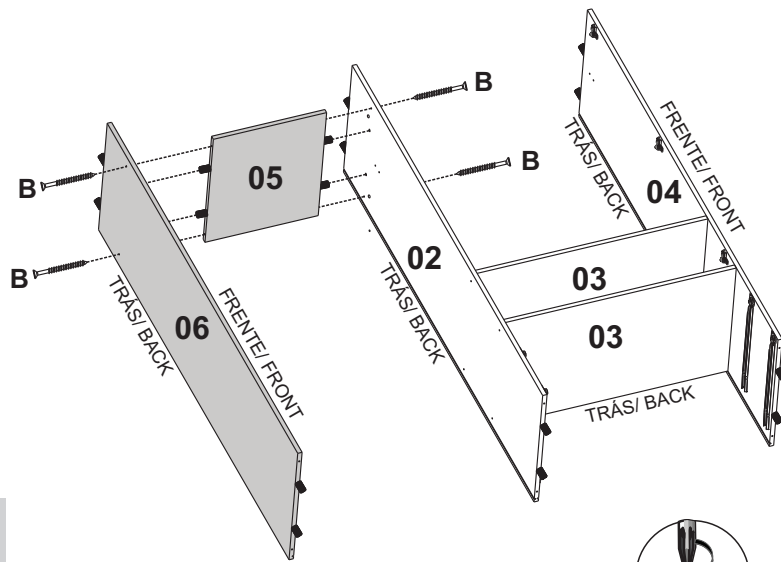

B=04

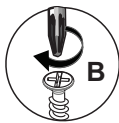
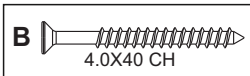

5

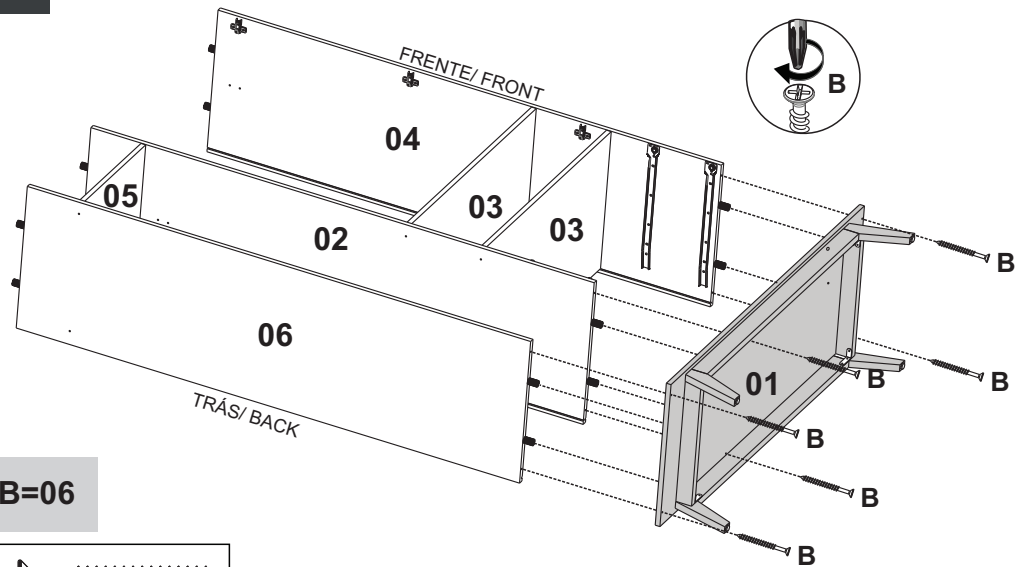

B=06

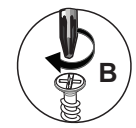
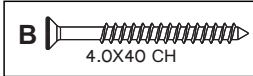

6



Encaixar no rasgo/  
Fit in the rip/  
Encaja en el rip

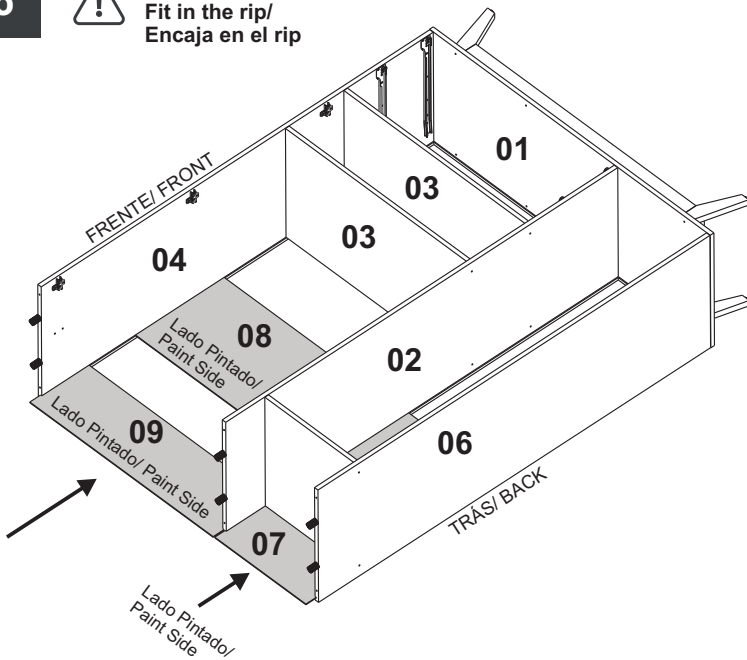

7



Encaixar no rasgo/  
Fit in the rip/  
Encaja en el rip

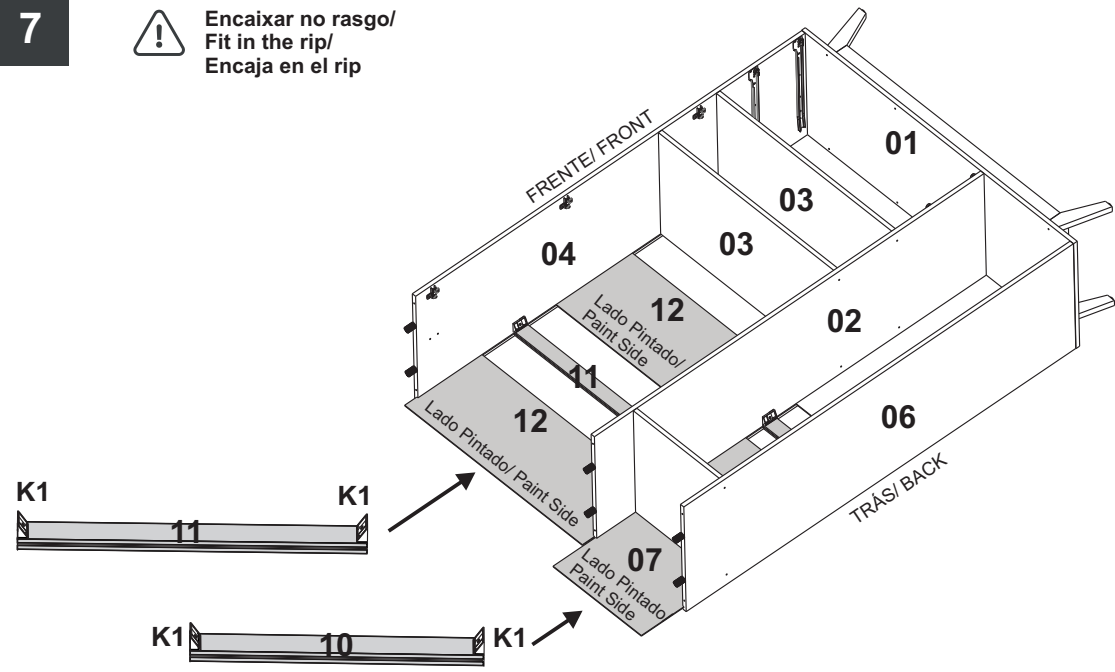

8



Encaixar no rasgo/  
Fit in the rip/  
Encaja en el rip

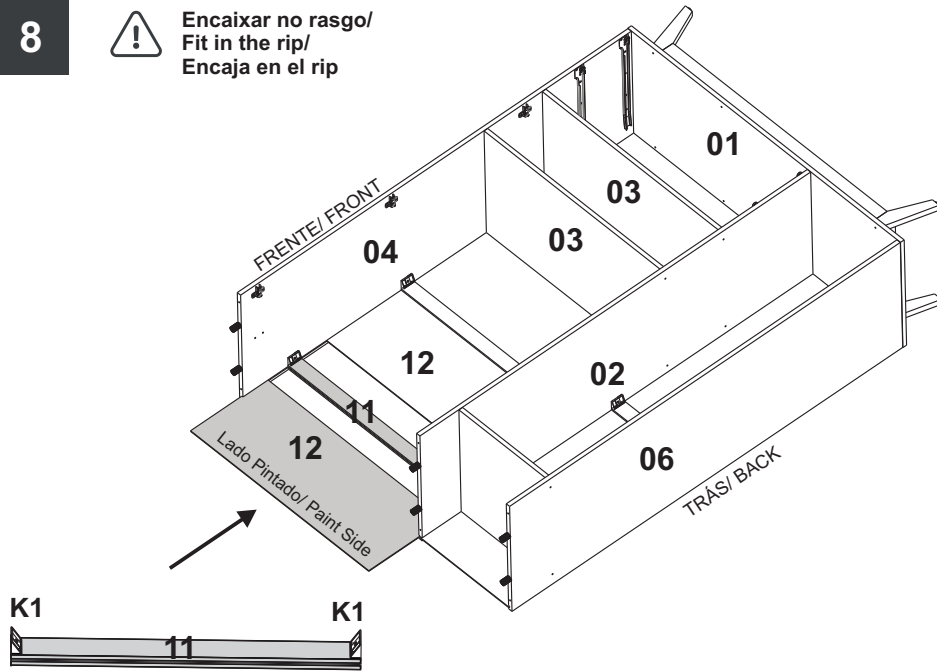

9

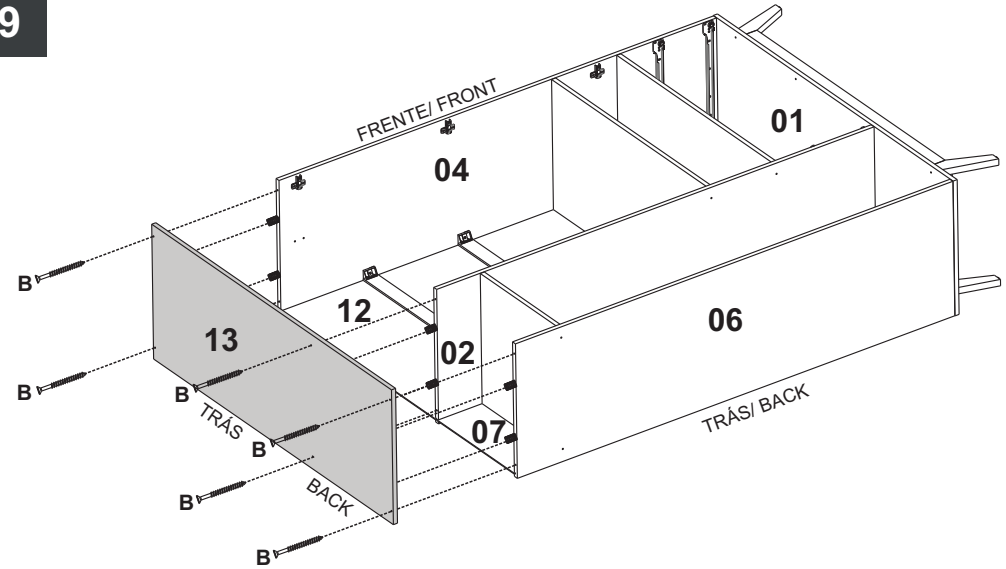

B=06

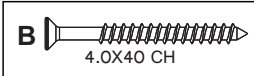

10



ATENÇÃO/ ATTENTION / ATENCION  
Parafusar as cantoneiras/ Screw the angles/  
Atornillar las esquinas.

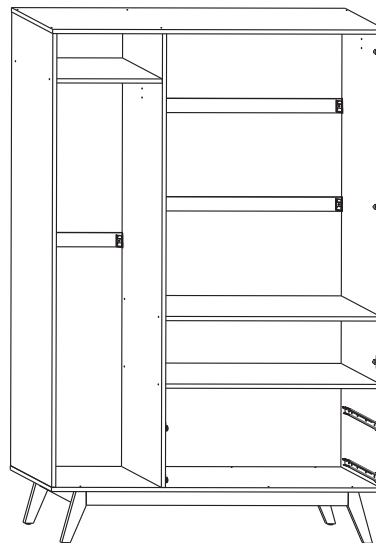
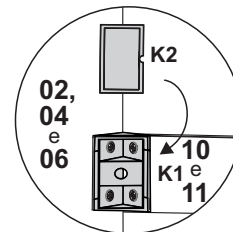
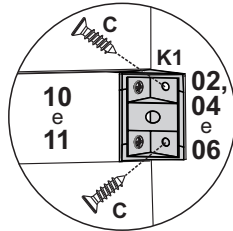
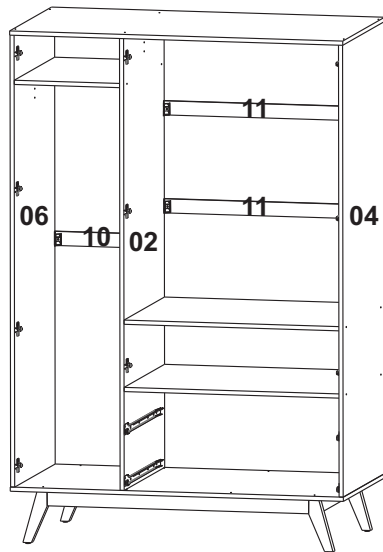

C=12  
K2=06

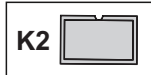
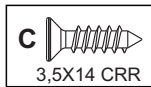

11

ATENÇÃO/  
ATTENTION/ ATENCION

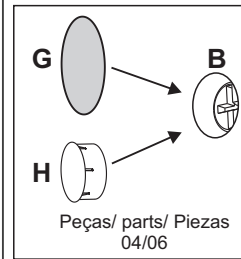

G=08  
H=06

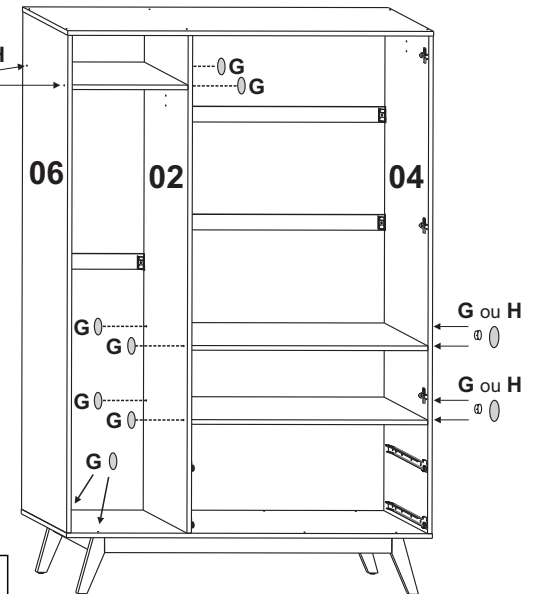

12

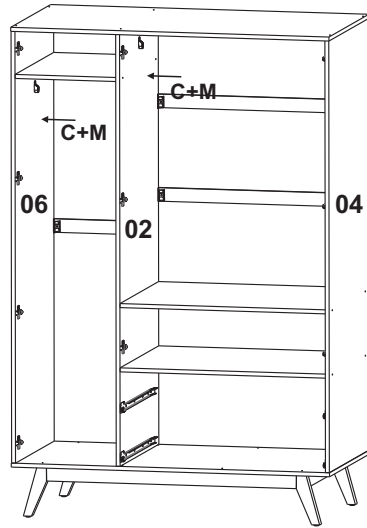

FIXAR/  
FIXING/ FIJACION  
Peças/ Parts/ Piezas  
02 / 04 / 06.

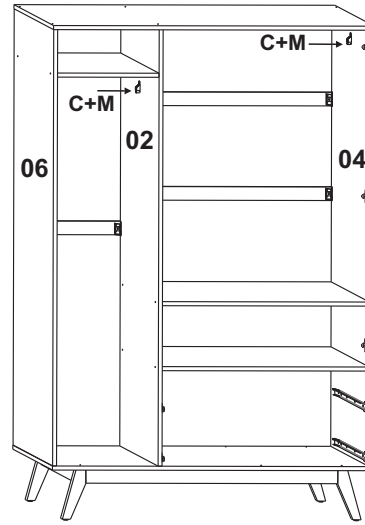
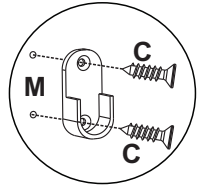

ATENÇÃO/ ATTENTION /  
ATENCIÓN

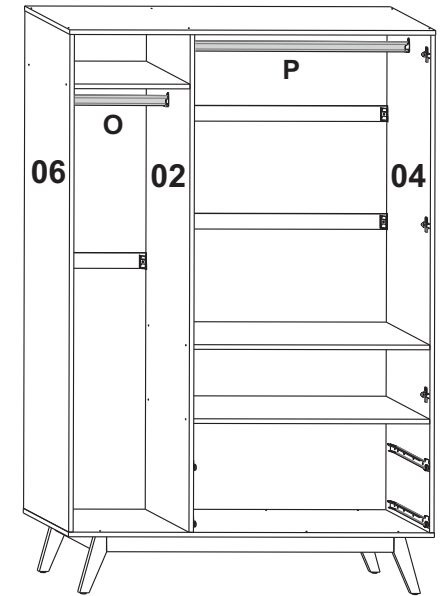
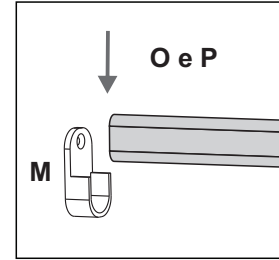

C=08  
M=04  
O=01  
P=01

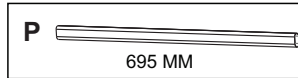
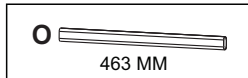
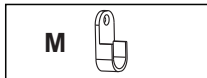
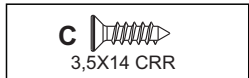

13

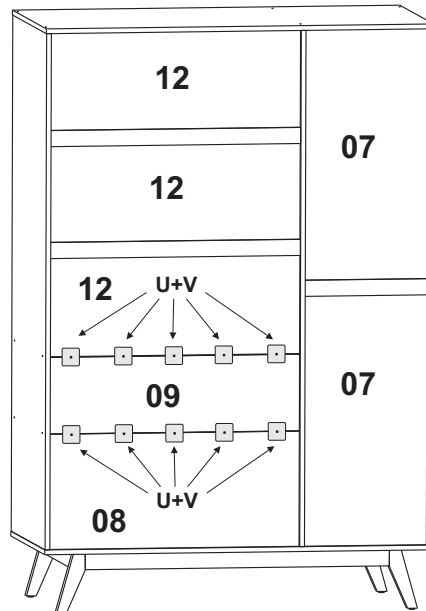
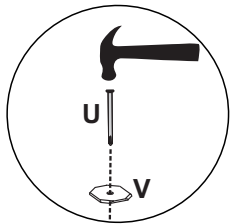

U=10  
V=10

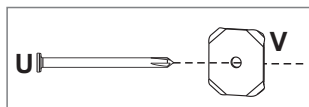

14

ATENÇÃO/  
ATTENTION / ATENCIÓN

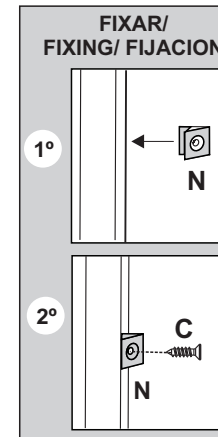

C=18  
N=18

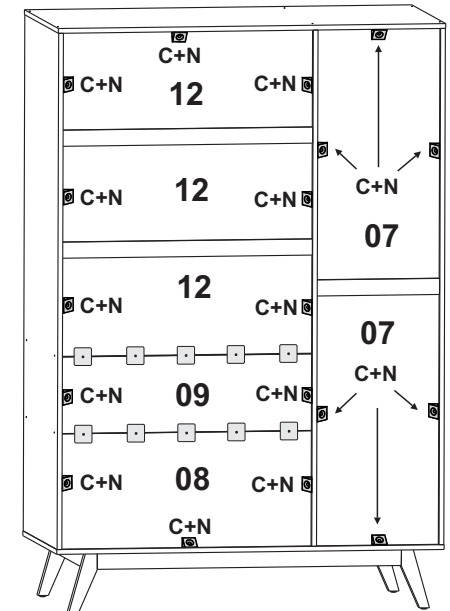
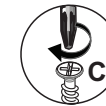
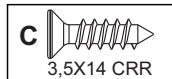

# 15

## MONTAGEM GAVETA / ASSEMBLY OF THE DRAWER / MONTAJE LE CÁJON

B=12  
C=22  
F=04  
G=04  
J2=04

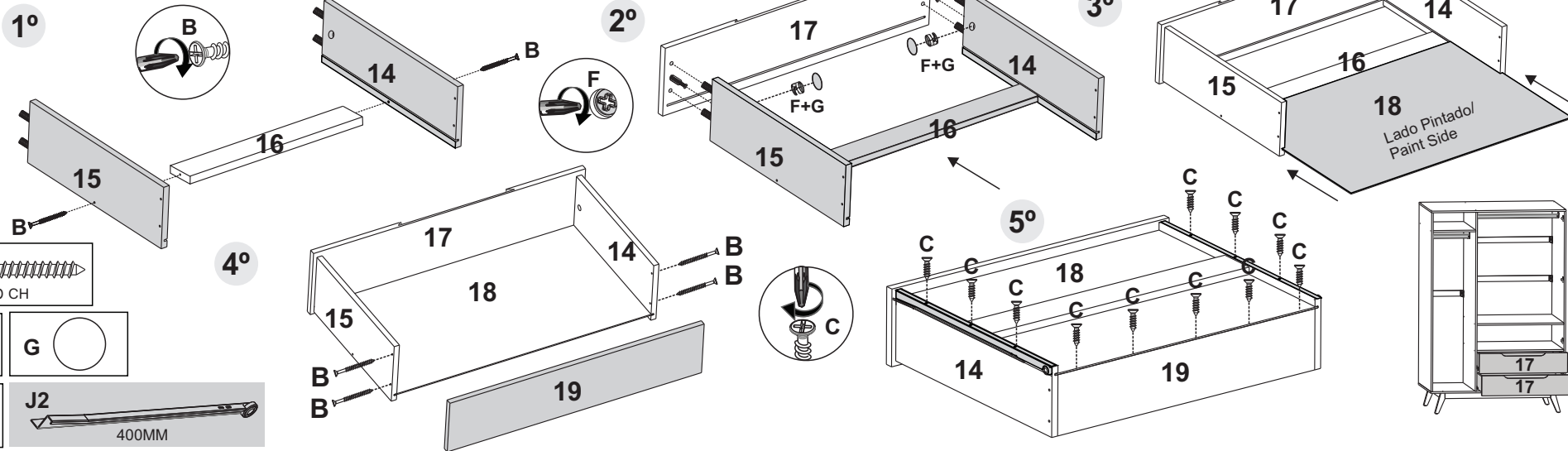
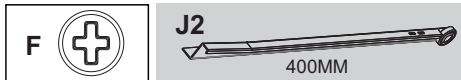
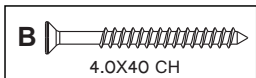

# 16



REGULAR E APERTAR/  
ADJUST AND TIGHTEN/  
AJUSTE Y APRIETE

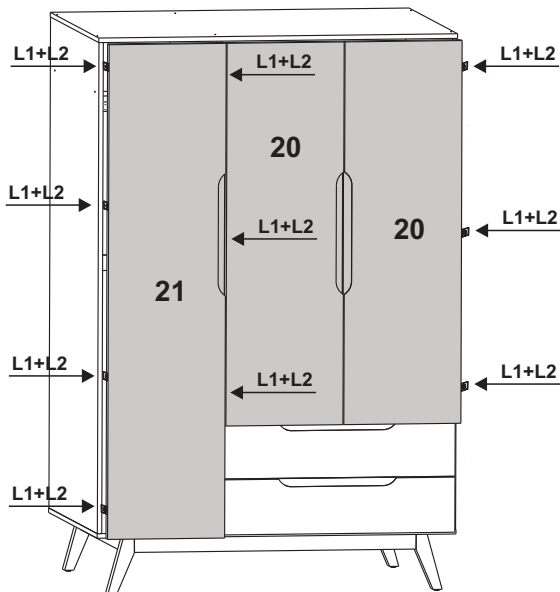

### ENCAIXAR/ TO FIT IN/ ENCAJAR

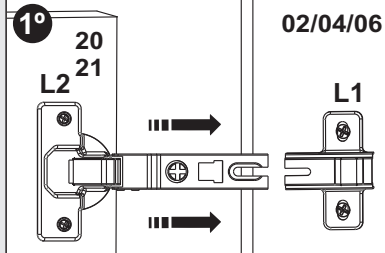

### REGULAR/ ADJUST/ AJUSTE

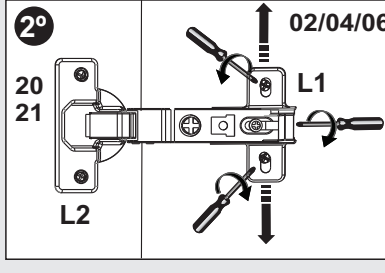

SE TIVER CRIANÇA, ACONSELHAMOS COLOCAR O KIT TOMBAMENTO, EVITANDO ACIDENTES.  
IF YOU HAVE A CHILD, WE RECOMMEND PUTTING THE TIPPING KIT, AVOIDING ACCIDENTS.  
SI TIENE UN HIJO, ACONSEJAMOS PONER EL KIT TIPPING, EVITANDO ACCIDENTES.

### ATENÇÃO/ ATTENTION / ATENCION

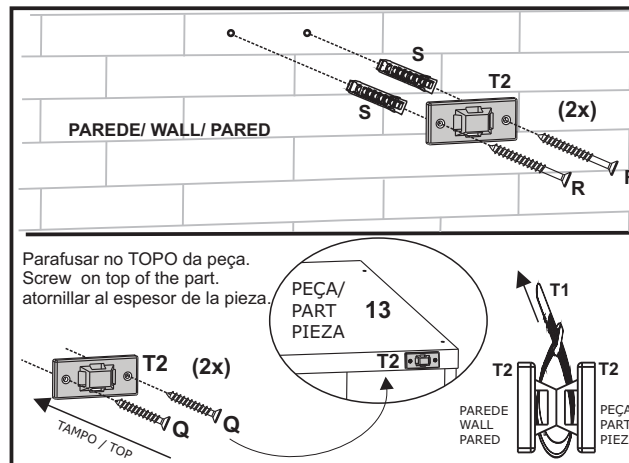

CUIDADO/  
CAUTION/  
PRECAUCION



# Agora que você já comprou o seu móvel, ele merece ser montado do jeito certo.

Erros de montagem causam mais de **60%** dos danos em móveis.

## Por que contratar?

Tranquilidade do **início ao fim** da montagem



### PROFISSIONAIS QUALIFICADOS

Especialistas certificados na **MadeiraMadeira Serviços**.



### FERRAMENTAS PROFISSIONAIS

que **protegem** seus móveis.



### AGENDAMENTO EM 24 HORAS

escolha a data e o turno **ideais para** você.



### GARANTIA DE 3 MESES

de cobertura **completa**.

**Mais de 1 MILHÃO DE MONTAGENS**  
★ com avaliação **4.7** ★

#### Mariana S., São Paulo

"Chegaram no horário e montaram tudo rapidamente. Serviço incrível!"



#### Carlos R., Belo Horizonte

"Tentei montar sozinho e foi um desastre. Com a **MadeiraMadeira Serviços** ficou perfeito."



#### Ana P., Rio de Janeiro

"Agendamento ágil e **montagem pontual e perfeita**. Recomendo demais!"



## Agende agora pelo QR Code

Madeira**Madeira** Serviços · Atendimento em todo o Brasil



Escaneie o QRCode