

CO12202 - AÉREO 0,80M

Manual de Montagem
Assembly Instructions
Instrucción de Montaje

decibal[®]
móveis

4º COSTA/REVÉS/BACK

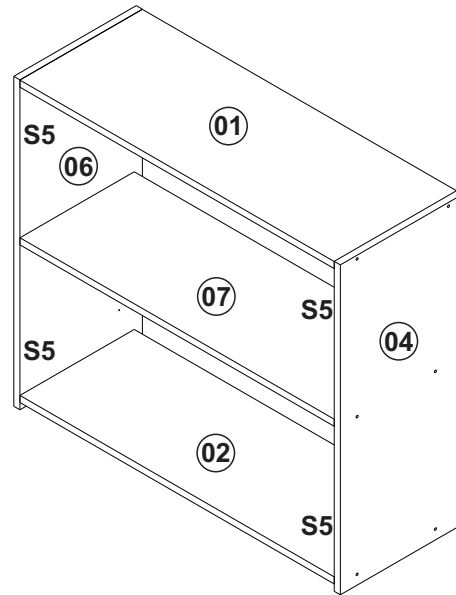
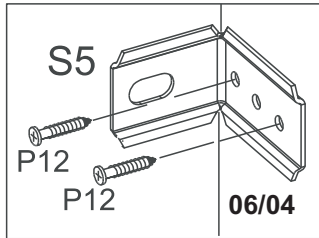

Fixação parede
Fixed in the wall

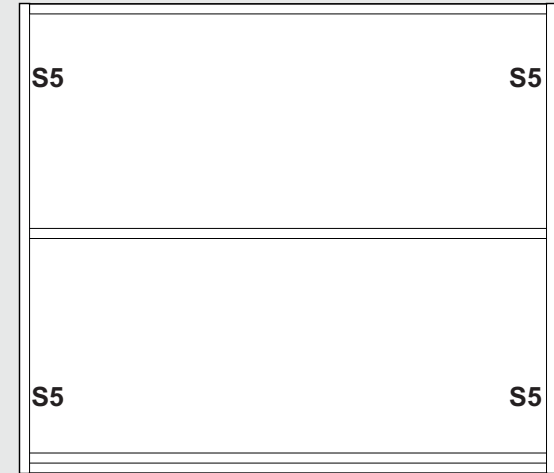
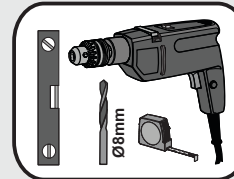
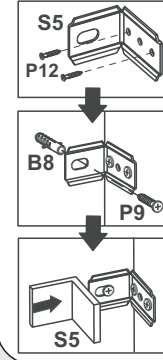

5º COSTA/REVÉS/BACK

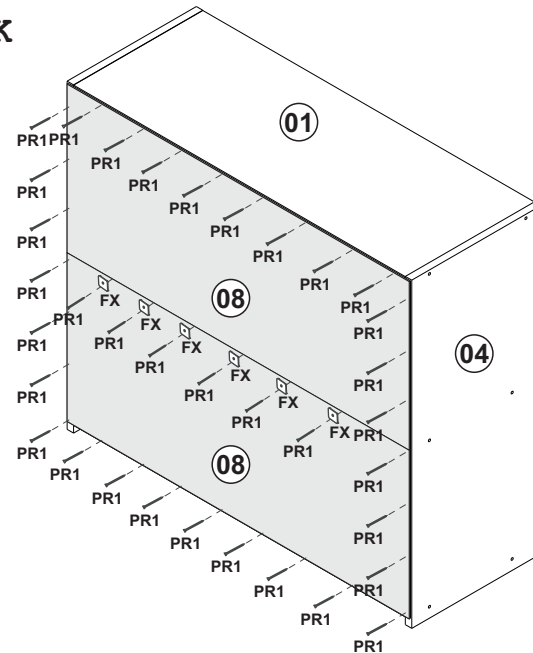
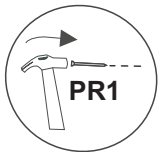

*PESO SUPORTADO.
*PESO SOPORTADO.
*WEIGHT SUPPORTED.

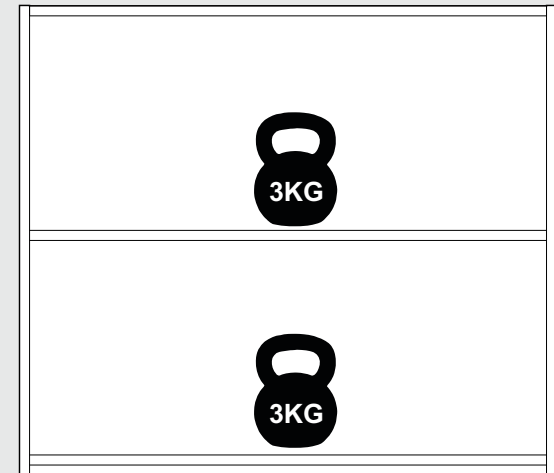

6°

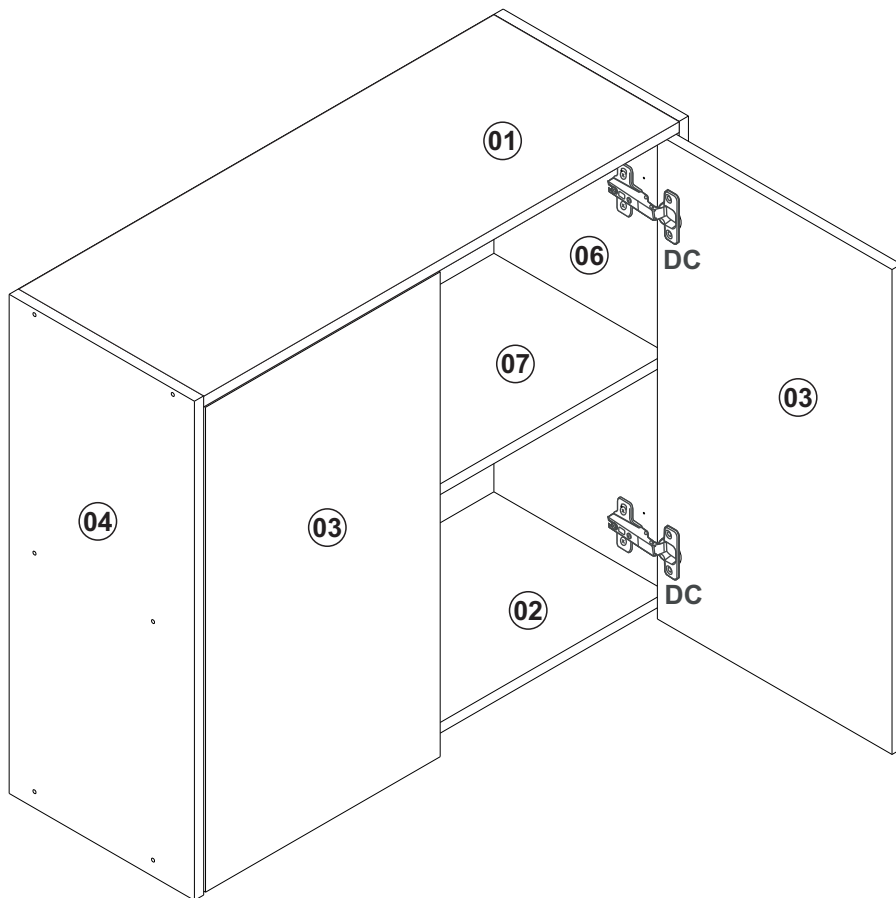

Relação de Peças/ Relación de Piezas/Parts List

N°	CÓDIGO/CODE	DESCRIÇÃO/DESCRIPCIÓN/DESCRIPTION	QTD/CANT	VOL.
1	0561093	BASE SUP	770X300X15MM	1
2	0561088	BASE INF	770X280X15MM	1
3	0561090	PORTA/PUERTA/DOOR	680X380X15MM	2
4	0561087	LATERAL ESQ/LATERAL/SIDE	700X300X15MM	1
5	0561091	TRAVESSA PUX/TRAVIESSA/TRVERSE	770X70X15MM	1
6	0561086	LATERAL DIR/LATERAL/SIDE	700X300X15MM	1
7	0561089	PRATELEIRA/ESTANTE/SHELF	770X280X15MM	1
8	0561092	COSTA/REVÉS/BACK	794X339X2, 8MM	2

www.decibal.com.br

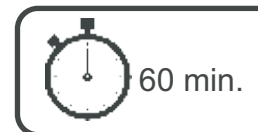

ATENÇÃO!!!! montadores e consumidores
* Ajustar o torque da parafusadeira para não danificar as peças escareando o parafuso *
ATENCIÓN!!!! montadores e consumidores
* Ajuste el torque del destornillador para no dañar las piezas avallanando el tornillo *
ATTENTION!!!! assemblers and consumers
* Adjust the torque of the screwdriver so as not to damage the parts by countersinking the screw *

Ferramentas necessárias
Necessary tools
Herramientas necesarias

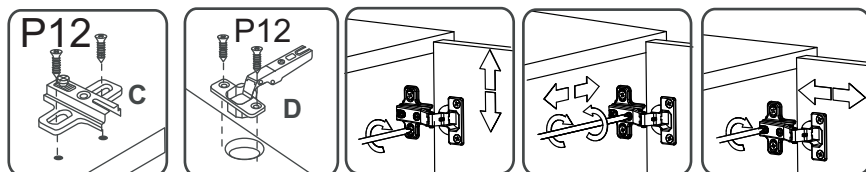
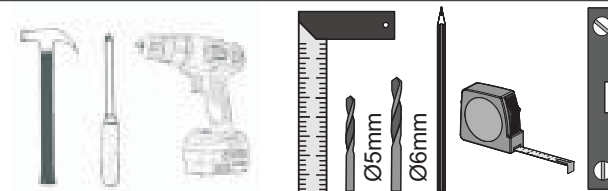







ATENÇÃO!!!! montadores e consumidores
* Para limpar o móveis utilize somente um pano úmido (umedecido em água pura ou água com sabão neutro). Depois, passe um pano seco. Evite a umidade excessiva.
* Evite usar álcool, água sanitária, detergente e outros produtos químicos, mesmo diluídos em água. Não utilize produtos abrasivos de nenhuma espécie







ATENCIÓN!!!! montadores e consumidores
* Para limpiar el mueble utilice solamente un paño húmedo (humedecido con agua limpia o con un jabón suave). Acontinución, utilice un paño seco. Evite el exceso de humedad.
* Evite uso de alcohol, hipocloridro solución basada, detergente y otros productos químicos, mismo diluidos en agua. No utilice productos abrasivos de ningún tipo.

ATTENTION!!!! assemblers and consumers
*To clean the furniture, use only a damp cloth (humidify it only in pure water ou water and neutral soap).After, use a dry cloth.Avoid excessive humidity.
*Avoid using alcohol, bleach, detergent and other chemical products, even diluted in water. Do not use any kind of abrasive cleaning agents to clean the furniture.
The use of such products may jeopardize the ?nal characteristics of the furniture.

Ferragens/ Herrajes/ Hardware

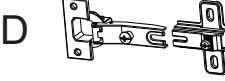
		escala (1:1)	
LEGENDA	DESCRIÇÃO/DESCRIPCIÓN/DESCRIPTION	CÓDIGO	QUANT.
P7	 PARAFUSO/TORNILLO/SCREW 4X45	01318	12
PR1	 PREGO/CLAVO/NAIL 10X10	01330	40
C2	 CAVILHA/TARUGO/DOWEL 6X30 MM	01211	14
P5	 PARAFUSO/TORNILLO/SCRE 4X25	01317	03
PU	 PARAFUSO UNIÃO/UNIÓN DETORNILLO /SCREW UNION	01495	02
P12	 PARAFUSO/TORNILLO/SCREW 3,5X13	09927	32
P9	 PARAFUSO/TORNILLO/SCREW 6X50	03827	04

escala (N/A)

LEGENDA	DESCRIÇÃO/DESCRIPCIÓN/DESCRIPTION	CÓDIGO	QUANT.
CL	 COLA/PEGAMENTO/GLUE	01213	01
ET	 ETIQUETA LOGO DECIBAL/LABEL DECIBAL	01312	01
B8	 BUCHA/BUJE/BUCHING (8mm)	01311	04
DC	 DOBRADIÇA/BISAGRA/HINGE D=35mm C=(Super Alta) Amortecimento	12627	04
S5	 SUPORTE AÉREO/APOYO AÉREO/AIR SUPPORT	03828	04
FX	 FIXADOR COSTA/FIJADOR FONDO/FIXER COAST	01331	06
AD	ADESIVO/ADHESIVO/ADHESIVE 	15mm	15

