

CO14401 - MÓDULO FORNO

Manual de Montagem
 Assembly Instructions
 Instrucción de Montaje

decibal[®]
 móveis

Produto Montado
 Producto final
 Assembled

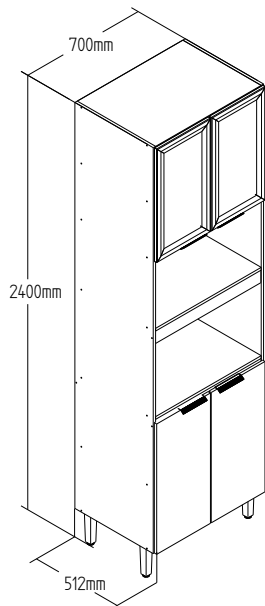

1º

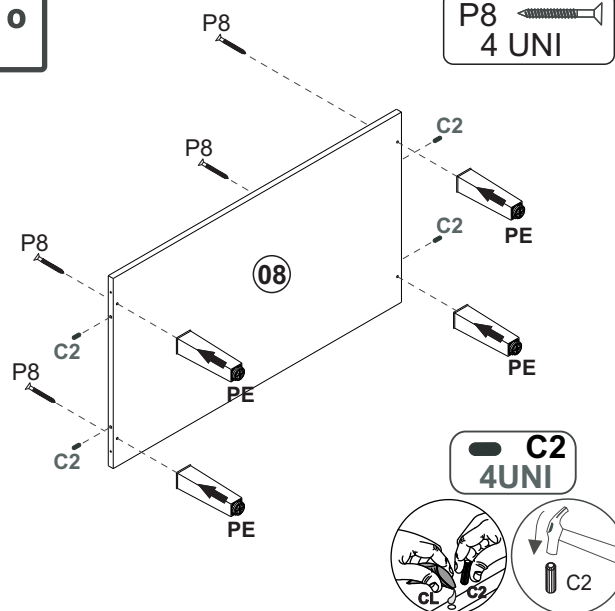

2º

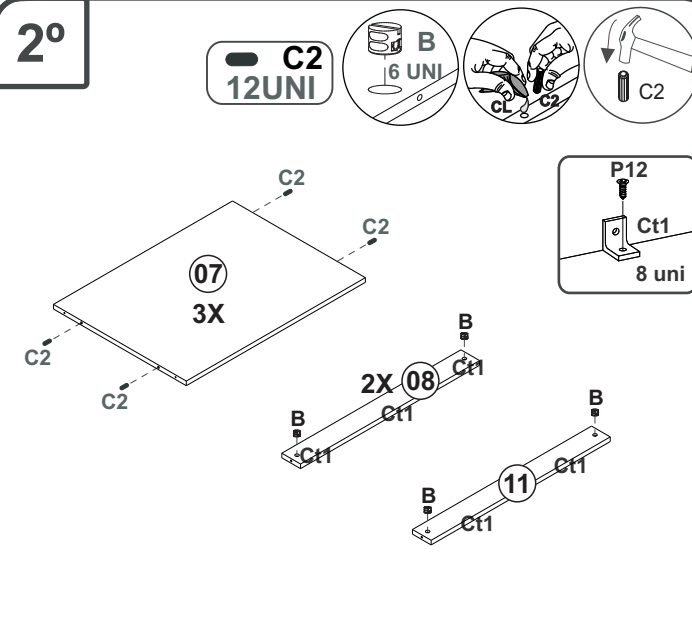

02º

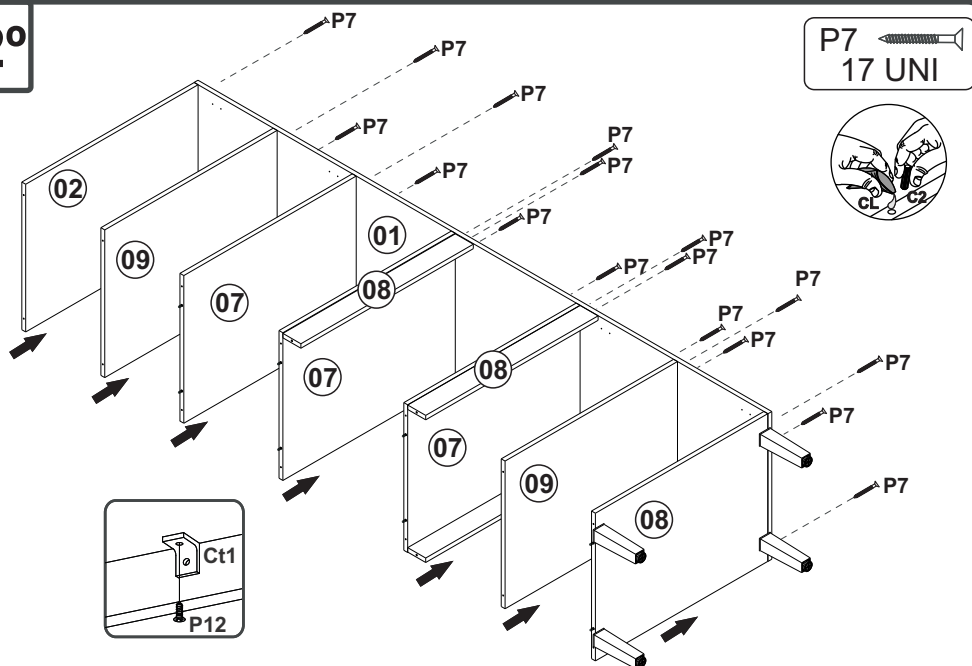

03º

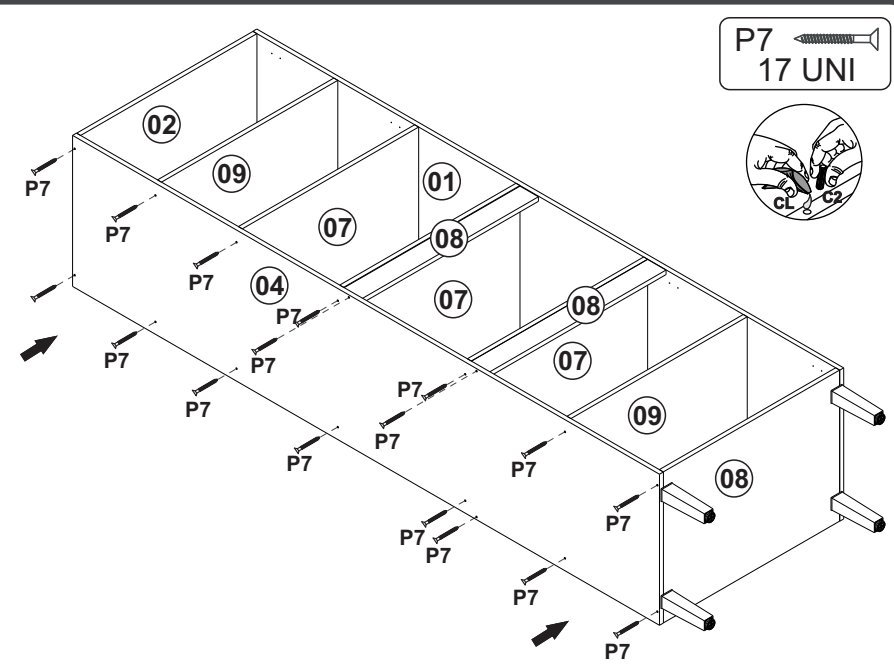

CO14401 - MÓDULO FORNO

Manual de Montagem
 Assembly Instructions
 Instrucción de Montaje

06°

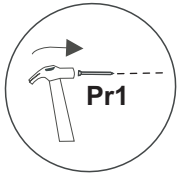

P1 4 UNI

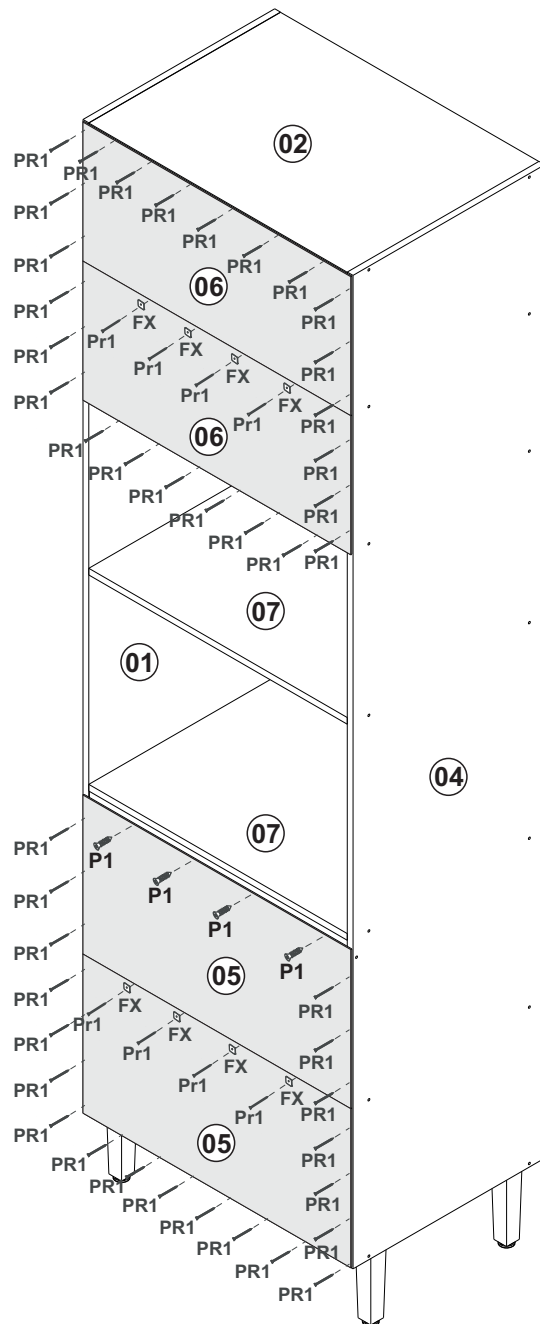

06°



*PESO SUPORTADO.
 *PESO SOPORTADO.
 *WEIGHT SUPPORTED.

Fixação parede

Fixed in the wall

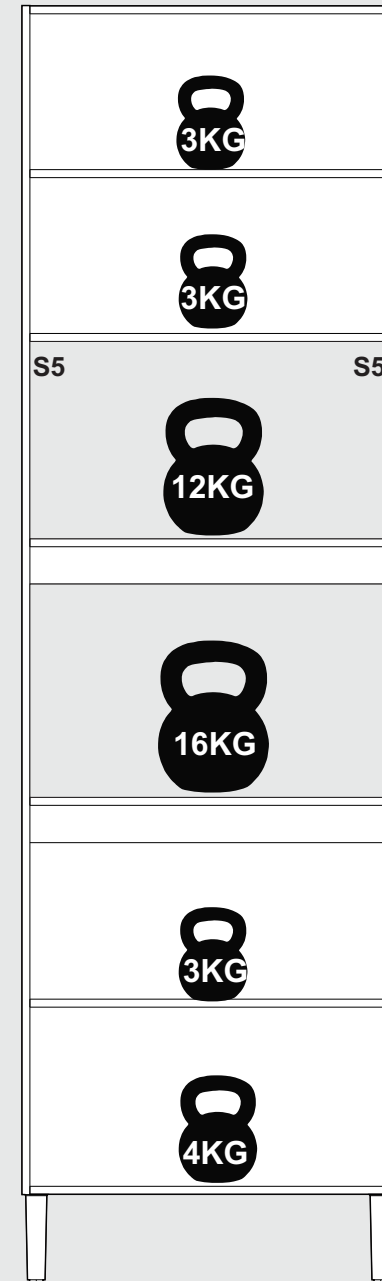
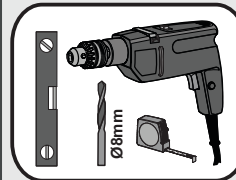
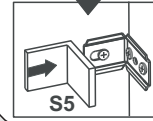
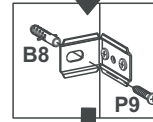

CO14401 - MÓDULO FORNO

Manual de Montagem
Assembly Instructions
Instrucción de Montaje

decibal[®]
móveis



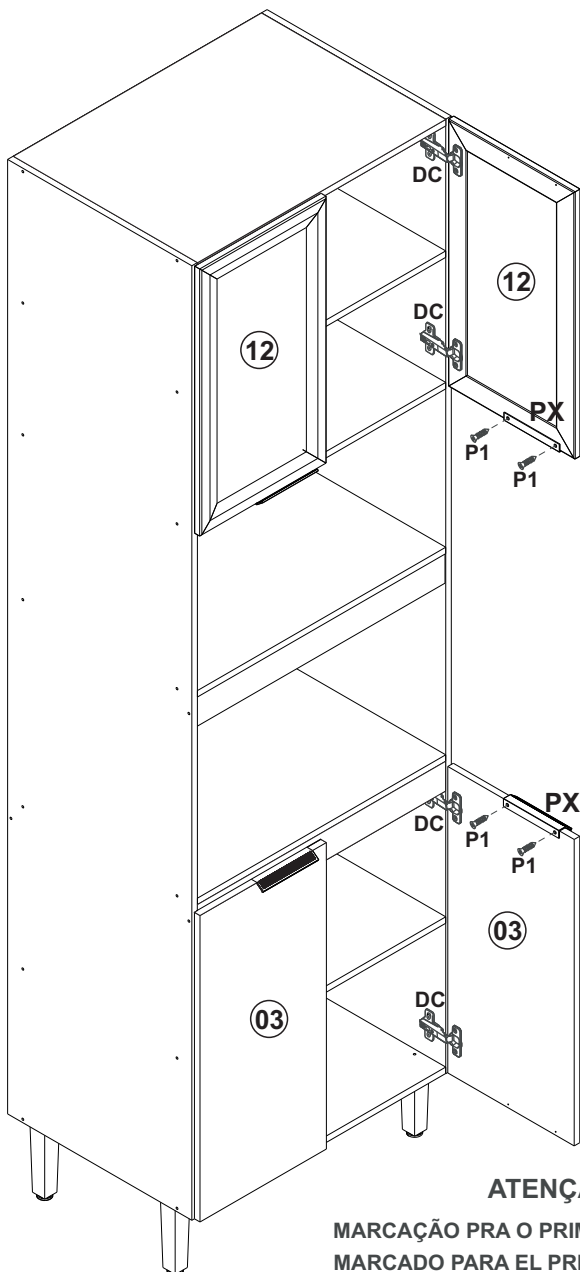







8°

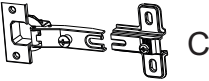

ATENÇÃO!!!!

MARCAÇÃO PRA O PRIMEIRO FURO DO PUXADOR
MARCADO PARA EL PRIMER AGUJERO
MARKING FOR THE FIRST HANDLE HOLE

escala (N/A)









LEGENDA	DESCRIÇÃO/DESCRIPCIÓN/DESCRIPTION	CÓDIGO	QUANT.
CL	 COLA/PEGAMENTO/GLUE	01213	01
ET	 ETIQUETA LOGO DECIBAL/LABEL DECIBAL	01312	01
AD	 ADESIVO/ADHESIVO/ADHESIVE	15mm	34
Ct1	 CANTONEIRA/PIEZA L/SHEET	03077	08
BT	 BATENTE/BATIENTE DE SILICONA/SILICONE STOP 8MM	02921	08
DC	 DOBRADIÇA/BISAGRA/HINGE D=35mm C=Alta (AMORTECIMENTO)	12615	08
FX	 FIXADOR COSTA/FIJADOR FONDO/FIXER COAST	01331	10
S5	 CAPA SUPORTE AÉREO /PORTADA APOYO AÉREO/AIR SUPPORT COVER	03828	02
PE	 PÉ/PATA/FOOT (170MM)	12003	04
PX	 PUXADOR/PEGADOR /HANDLE CHAMPANHE(AKEO 128MM)	12611	04
B	 BUCHA / BUJE / BUCHING 8 MM	01311	02

CO14401 - MÓDULO FORNO

Manual de Montagem
Assembly Instructions
Instrucción de Montaje

decibal®
móveis

Ferragens/ Herrajes/ Hardware escala (1:1)

LEGENDA	DESCRIÇÃO/DESCRIPCIÓN/DESCRIPTION	CÓDIGO	QUANT.
P7	 PARAFUSO/TORNILLO/SCREW 4X45	01318	34
PR1	 PREGO/CLAVO/NAIL 10X10	01330	70
C2	 CAVILHA/TARUGO/DOWEL 6X30 MM	01211	18
P12	 PARAFUSO/TORNILLO/SCREW 3,5X13 CABEÇA FLANGEADA	09927	64
P9	 PARAFUSO/TORNILLO/SCREW 6X50	03827	02
P1	 PARAFUSO/TORNILLO/SCREW 3,5X12	01328	12
P8	 PARAFUSO/TORNILLO/SCREW 5X45	01320	04
PU	 PARAFUSO UNIÃO/UNIÓN DETORNILLO /SCREW UNION	01495	02

Relação de Peças/ Relación de Piezas/Parts List

Nº	CÓDIGO/CODE	DESCRIÇÃO/DESCRIPCIÓN/DESCRIPTION	QTD/CANT	VOL.
1	0560804	LATERAL DIR/LATERAL/SIDE 2230X497X15MM	1,00	1
2	0560806	BASE SUP 670X497X15MM	1,00	1
3	0560810	PORTA INF/PUERTA/DOOR 716X341X15MM	2,00	1
4	0560805	LATERAL ESQ/LATERAL/SIDE 2230X497X15MM	1,00	1
5	0560811	COSTA INF/REVÉS/BACK 694X370X2,8MM	2,00	1
6	0560812	COSTA SUP/REVÉS/BACK 694X312X2,8MM	2,00	1
7	0560807	PRATELEIRA EXT/ESTANTE/SHELF 670X497X15M	3,00	2
8	0560803	BASE INF 670X497X15M	1,00	2
9	0560808	PRATELEIRA INT/ESTANTE/SHELF 670X497X15M	2,00	2
10	0560809	TRAVESSA FRT/TRAVIESA/TRVERSE 670X70X15M	2,00	2
11	0561016	TRAVESSA TRS/TRAVIESA/TRVERSE 670X70X15M	1,00	2
12	12448	PORTA TELA/PUERTA/DOOR 624X341X18MM	2,00	3

ATENÇÃO!!!! montadores e consumidores

* Ajustar o torque da parafusadeira para não danificar as peças escareando o parafuso *

ATENCIÓN!!!! montadores e consumidores

* Ajuste el torque del destornillador para no dañar las piezas avallanando el tornillo *

ATTENTION!!!! assemblers and consumers

* Adjust the torque of the screwdriver so as not to damage the parts by countersinking the screw *

Ferramentas necessárias
Necessary tools
Herramientas necesarias

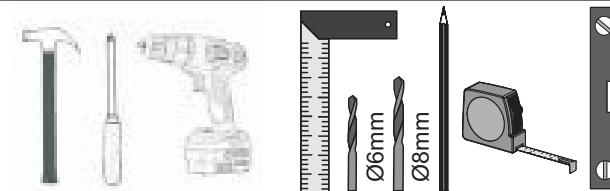

ATENÇÃO!!!! montadores e consumidores

* Para limpar o móveis utilize somente um pano úmido (umedecido em água pura ou água com sabão neutro). Depois, passe um pano seco. Evite a umidade excessiva.

* Evite usar álcool, água sanitária, detergente e outros produtos químicos, mesmo diluídos em água. Não utilize produtos abrasivos de nenhuma espécie

ATENCIÓN!!!! montadores e consumidores

* Para limpiar el mueble utilice solamente un paño húmedo (humedecido con agua limpia o con un jabón suave). A continuación, utilice un paño seco. Evite el exceso de humedad.

* Evite uso de alcohol, hipoclorídico solución basada, detergente y otros productos químicos, mismo diluídos en agua. No utilice productos abrasivos de ningún tipo.

ATTENTION!!!! assemblers and consumers

* To clean the furniture, use only a damp cloth (humidify it only in pure water ou water and neutral soap). After, use a dry cloth. Avoid excessive humidity.

* Avoid using alcohol, bleach, detergent and other chemical products, even diluted in water. Do not use any kind of abrasive cleaning agents to clean the furniture.

The use of such products may jeopardize the ?nal characteristics of the furniture.

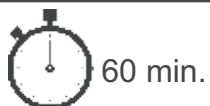

60 min.



1 montador
1 ajustador
1 Fitter

www.decibal.com.br



Medida em mm