

Medidas são externas e podem variar mais ou menos 10mm

PRODUTOS NÃO PODEM MOLHAR NEM SER EXPOSTOS AO SOL OU EM LUGARES ÚMIDOS

Limpar com pano seco, não usar produtos químicos, abrasivos ou pontiagudos

FRONTÃO
LADO FRISADO

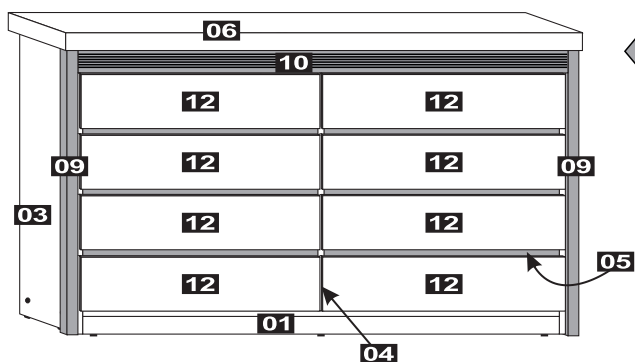



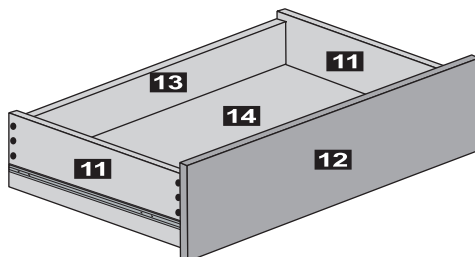
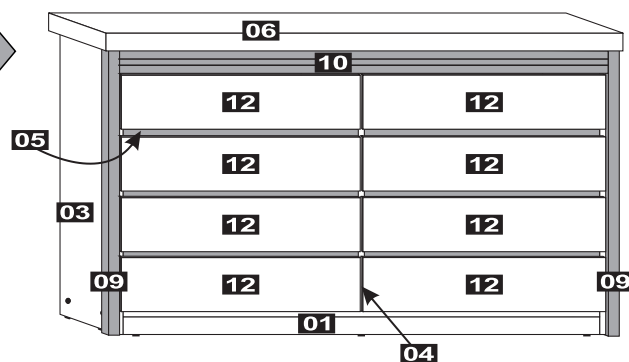

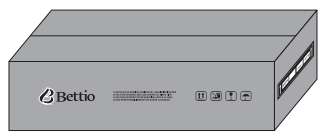







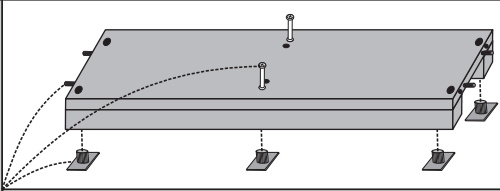
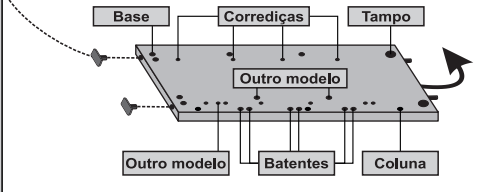

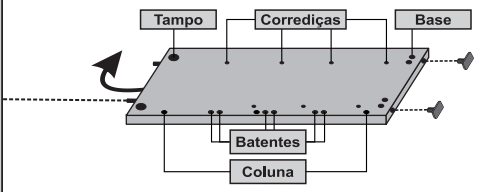

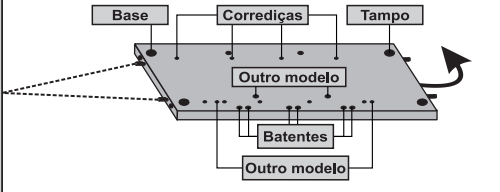

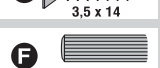
FRONTÃO
LADO FRISO / MOLD

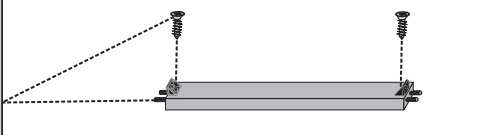

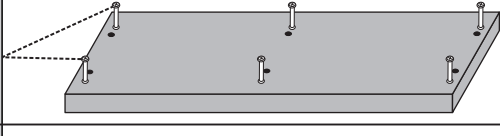
SEQ.	Q2 VOLUMES	DESENHO DOS VOLUMES	MEDIDA A x L x C	M ³	PESO	CÓDIGO
1/2	BASE					10524
2/2	GAVETA					10492
TOTAL						

MEDIDAS SÃO EXPRESSAS EM MM - PESO EM KG - VOLUME EM M³

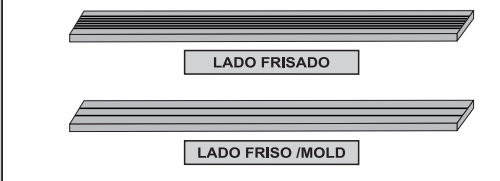
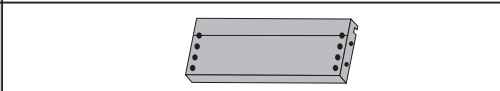
Dependendo do fornecedor de chapas de MDF, o peso pode variar.

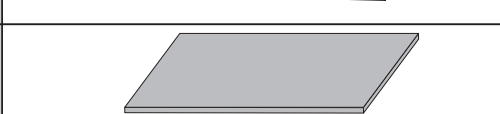
FIXAR AS FERRAGENS	DESENHO DAS PEÇAS	ORD.	QTD.	NOME DA PEÇA	MEDIDA (mm)	MDF (mm)	ESTÁ NO VOLUME	CÓDIGO
FIXAR SAPATAS E CAVILHAS NA BASE E LATERAIS   	 	01	01	BASE CO-1385 /410	1385 x 410	15	BASE	10348
 		03	01	LATERAL ESQUERDA CO-1015 /410	1015 x 410	15	BASE	10337
		04	01	DIVISÃO CO-975 /405	975 x 405	15	BASE	07531
  	 FIXAR CANTONEIRAS PLÁSTICAS ALINHADAS COM A BORDA LATERAL, EM DOIS BATENTES	05	06	BATENTE GAVETA CO-685 /55	685 x 55	15	GAVETA	10349
		06	01	TAMPO CO-1455 /445	1455 x 445	25	BASE	10350
		07	03	FUNDO (F3) CO-1410 /323	1410 x 323	03	BASE	10351
		08	02	PERFIL H (F3) CO-1385 /35	1385 x 35	12	BASE	10352
		09	02	COLUNA LATERAL CO-1015 /35	1015 x 35	25	BASE	10341
ANTES DE FIXAR A CANTONEIRA, VERIFICAR QUAL SERÁ O LADO EXTERNO DO FRONTÃO LADO FRISADO OU LADO FRISO /MOLD		10	01	FRONTÃO CO-1397 /90	1397 x 90	15	BASE	10353
		11	16	LATERAL GAVETA (F6) CO-395 /160	395 x 160	15	GAVETA	06381
		12	08	FRENTE GAVETA (F6) CO-690 /200	690 x 200	15	GAVETA	10763
		13	08	TRASEIRO GAVETA CO-630 /130	630 x 130	15	GAVETA	10355
		14	08	FUNDO GAVETA (F6) CO-645 /402	645 x 402	06	GAVETA	10764

ORD.	DESENHO DA FERRAGEM	BASE	NOME DA FERRAGEM	PARA FIXAR	CÓDIGO
A		10	SAPATA COM PINO	Base e laterais ou nos pés	00645
B		8P	CORREDIÇA TELESCÓPICA 400 mm	Gavetas	00006
C		200	PARAF. 3,5 x 14 (CAB. CHATA)	Cantoneiras plásticas, uniões, corrediças e suportes triangulares	07857
D		04	BUCHA CILÍNDRICA 12 x 12	Laterais na base	07927
E		04	PARAF. 5 x 50 (CAB. FLANG.)	Laterais na base	07856
F		68	CAVILHA 6 x 30	Base, divisão, batentes de gavetas, tampo nas laterais e gavetas	01910
G	TAMBOR PINO	08	CONJUNTO MINIFIX	Divisão e tampo nas laterais	01911
H		66	PARAF. 3,5 x 16 (CAB. FLANG.)	Fundos da cômoda e de gavetas	07858
I		12	CANTONEIRA PLÁSTICA	Batentes de gavetas centrais e frontão	10474
J		38	PARAF. 4 x 30 (CAB. CHATA)	Colunas laterais e traseiros de gavetas	07860
K		32	UNIÃO	Gavetas	03205
L		16	SUP. TRIANGULAR	Fundos de gavetas	02423

AS VEZES OS FUROS DAS CORREDIÇAS NÃO BATEM COM AS MARCAÇÕES
Fixar as corrediças alinhadas com os furos de marcações
e com a borda da frente das laterais e divisão

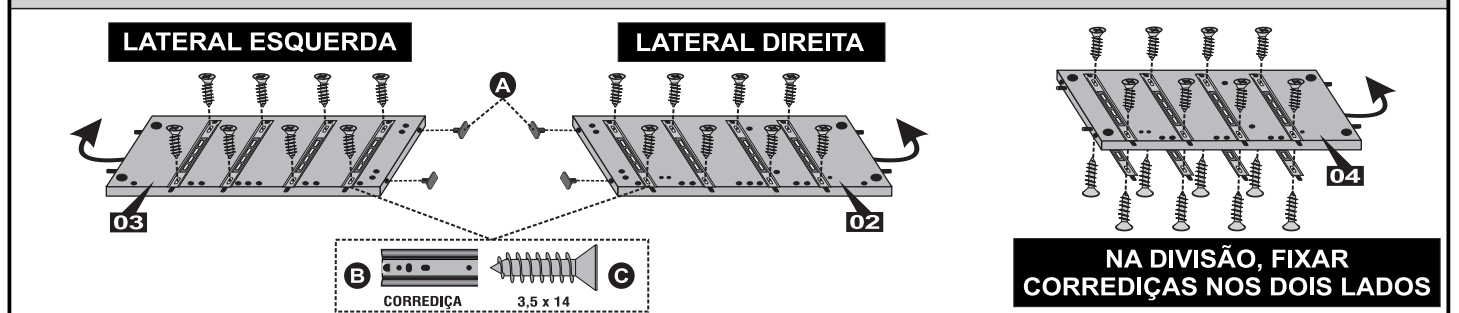

01 Fixar as laterais na base.

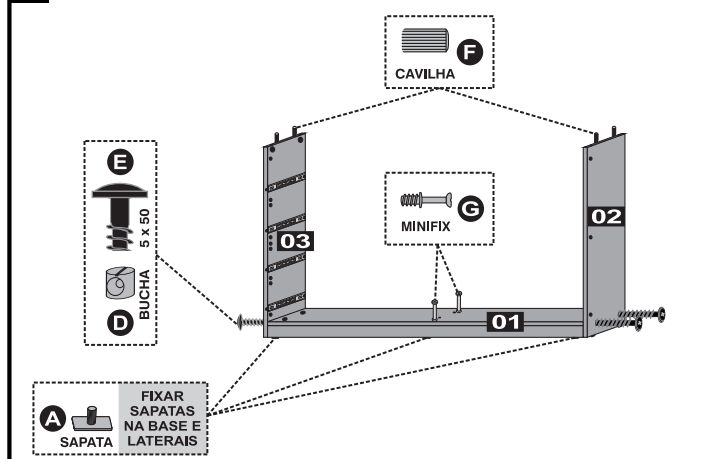

02 Fixar a divisão, encaixar os batentes nela e nas laterais, em seguida fixar o tampo.

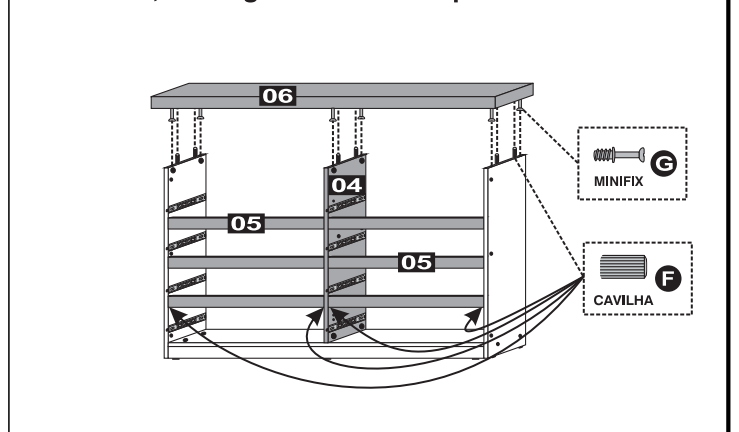

03 Fixar os fundos unindo-os com o perfil H.

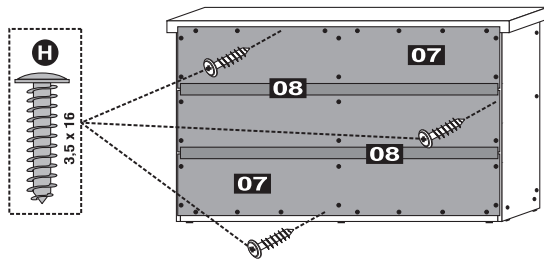

04 Fixar os dois batentes centrais nas laterais e divisão usando cantoneiras plásticas, em seguida fixar as colunas laterais.

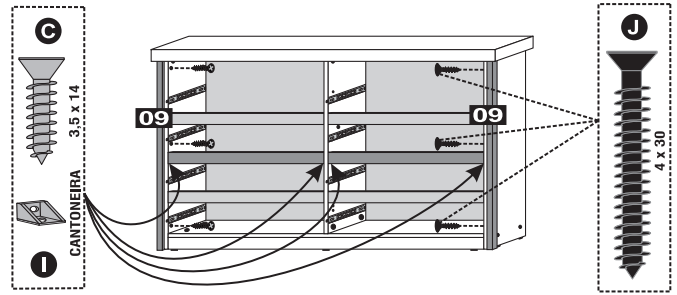

05 Antes de fixar as cantoneiras, verificar qual será o lado externo do frontão.

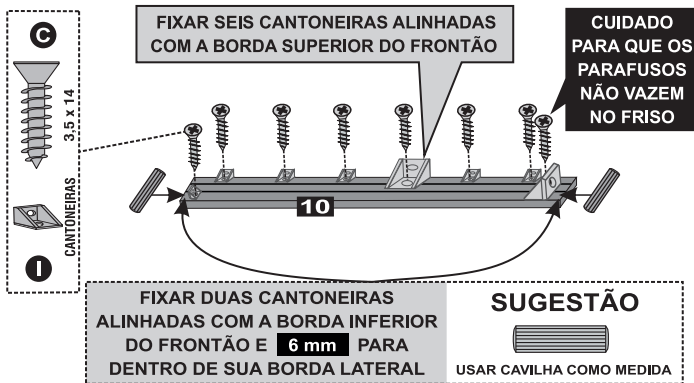

06 Fixar o frontão encostado nas laterais, divisão e tampo.

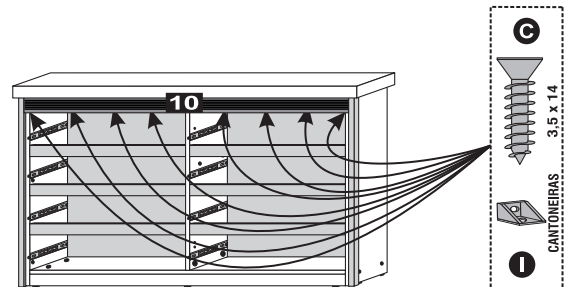

07 Fixar as uniões e cavilhas nas laterais fazendo par.

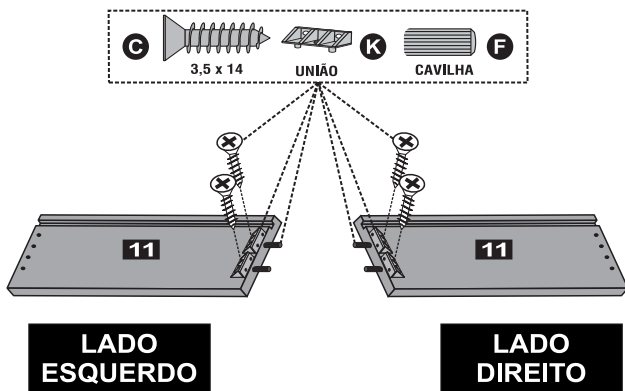

08 Montar as gavetas.

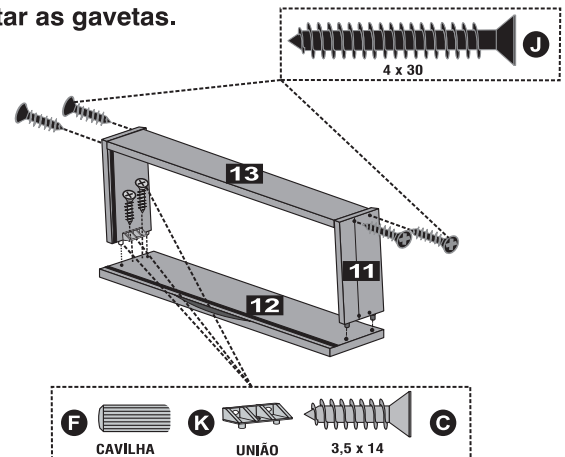

09 Fixar os fundos e suportes triangulares nas gavetas.

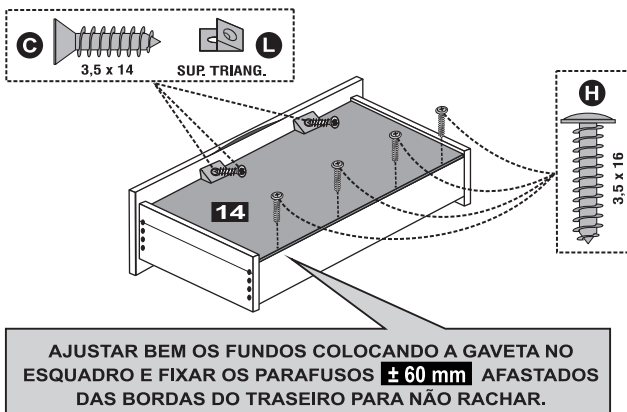

10 Fixar as corredeças nas linhas de marcações das laterais encostadas na frente de gaveta.

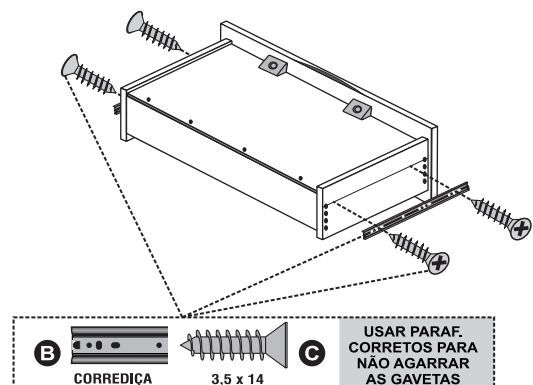

Solicitar Assist. Técnica pelo nome e código das peças e das ferragens, informando cor e número do lote.

Montador, obrigado pelo cuidado com nossos produtos. Deixe este manual com o consumidor.
Quaisquer dúvidas na montagem, falar com nosso controle de qualidade (32) 3539-7700 - tecnica@moveisbettio.com.br