

# CO14101 - AÉREO CANTO RETO

Manual de Montagem  
 Assembly Instructions  
 Instrucción de Montaje

decibal<sup>®</sup>  
 móveis

Produto Montado  
 Producto final  
 Assembled



Direita  
 Right  
 Derecha

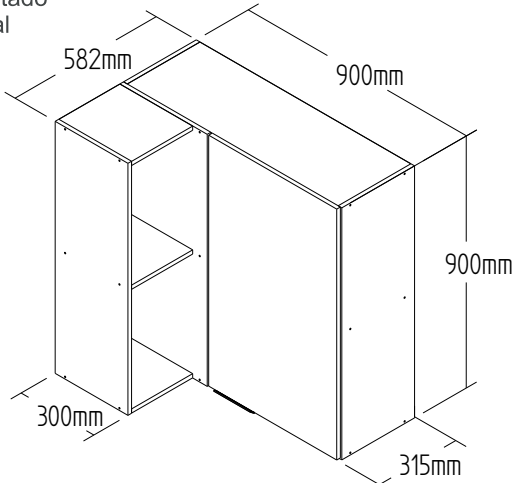

Verificar o lado desejado antes de efetuar a montagem  
 Check the desired side before mounting  
 Compruebe el lado deseado antes de montar

Possui montagem dois lados/tiene un montaje de dos lados/ It has two sides

Produto Montado  
 Producto final  
 Assembled



Esquerdo  
 left  
 Izquierda

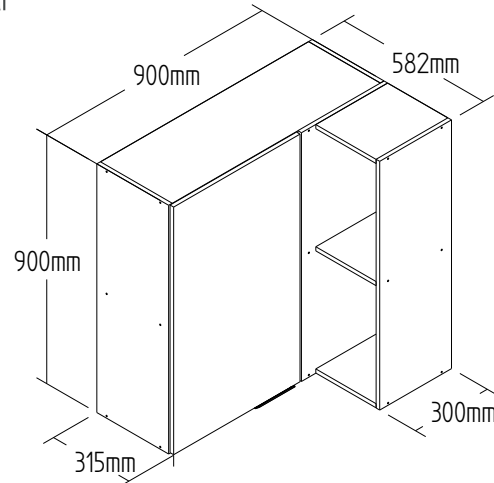

Possui montagem dois lados/tiene un montaje de dos lados/ It has two sides

01°

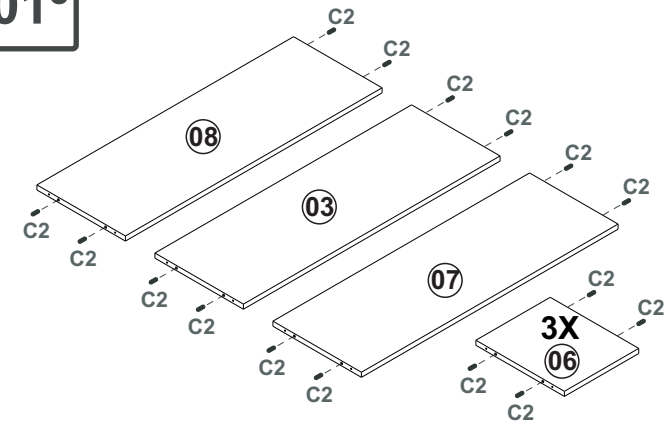

C2  
 36UNI

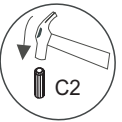

02°

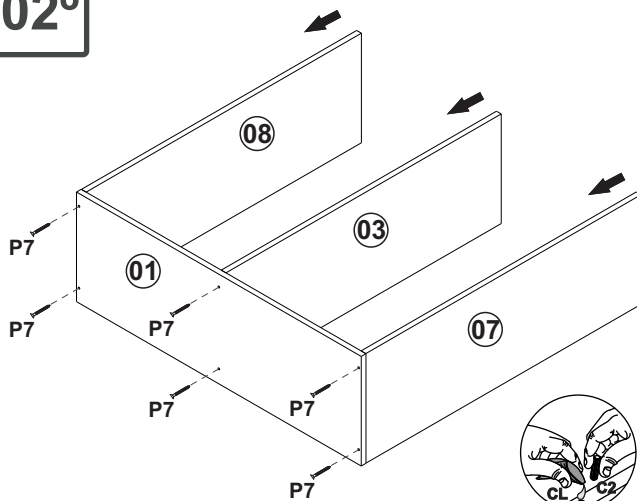

P7  
 6 UNI

03°

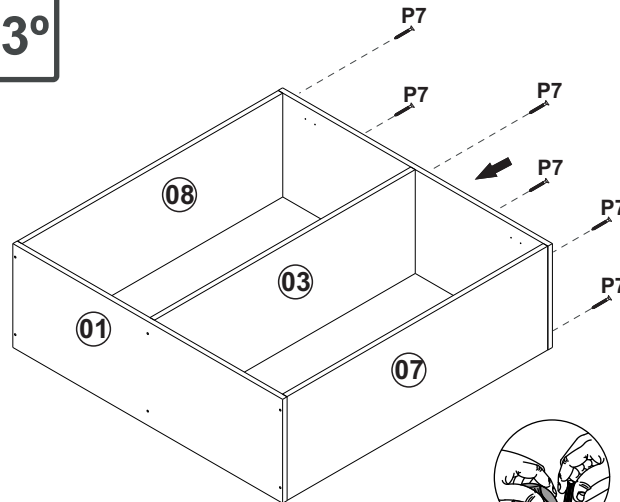

P7  
 6 UNI

04°

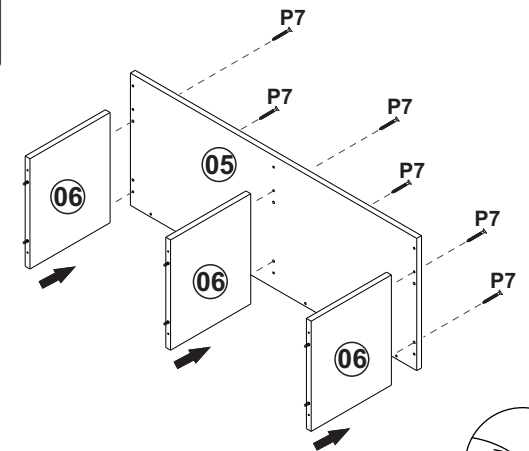

P7  
 6 UNI

# CO14101 - AÉREO CANTO RETO

Manual de Montagem  
Assembly Instructions  
Instrucción de Montaje

decibal<sup>®</sup>  
móveis

05°



Direita  
Right  
Derecha

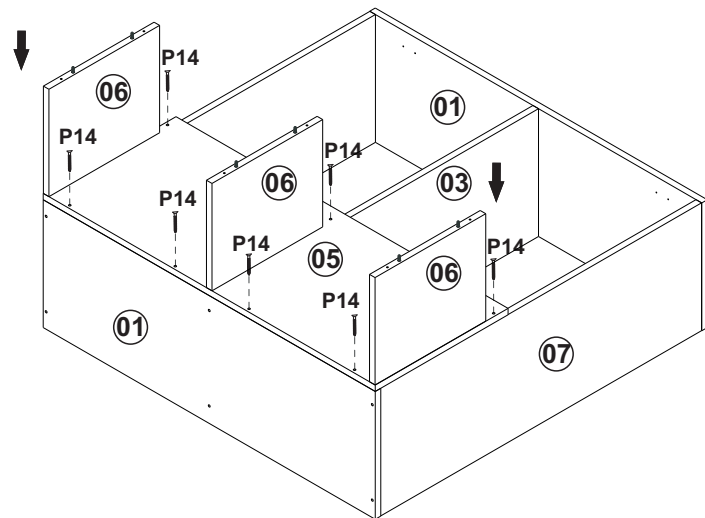

P14  
7 UNI

06°



Direita  
Right  
Derecha

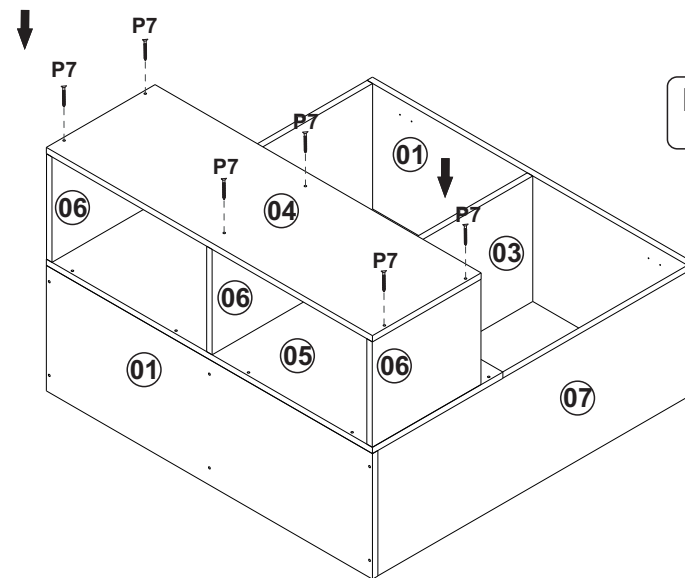

P7  
6 UNI

07°



Esquerdo  
left  
Izquierda

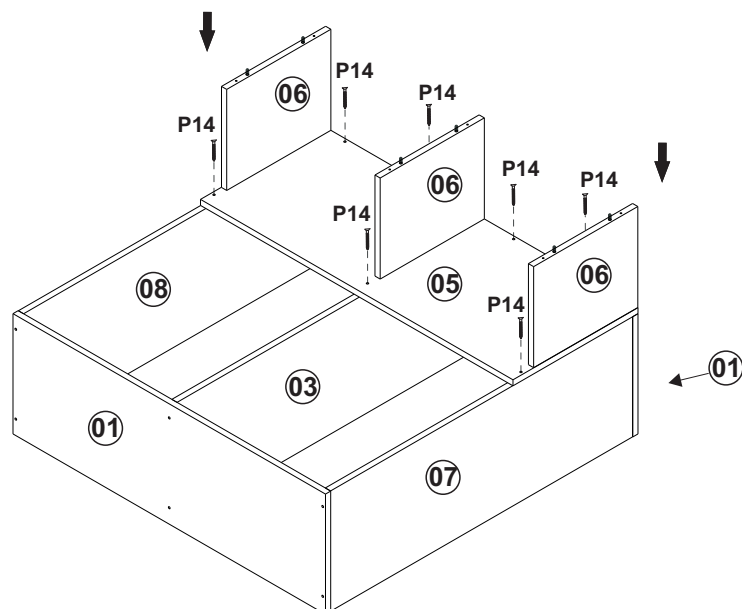

08°



Esquerdo  
left  
Izquierda

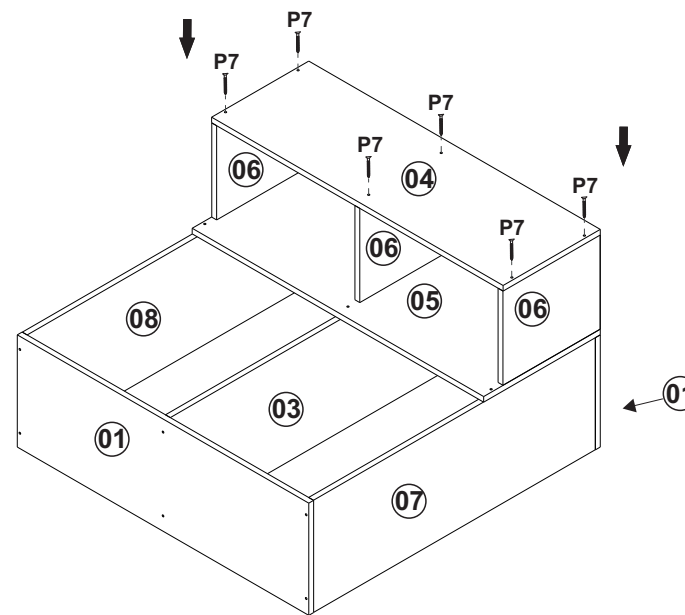

# CO14101 - AÉREO CANTO RETO

Manual de Montagem  
Assembly Instructions  
Instrucción de Montaje

decibal<sup>®</sup>  
móveis

## 09° COSTA/REVÉS/BACK



Direita  
Right  
Derecha

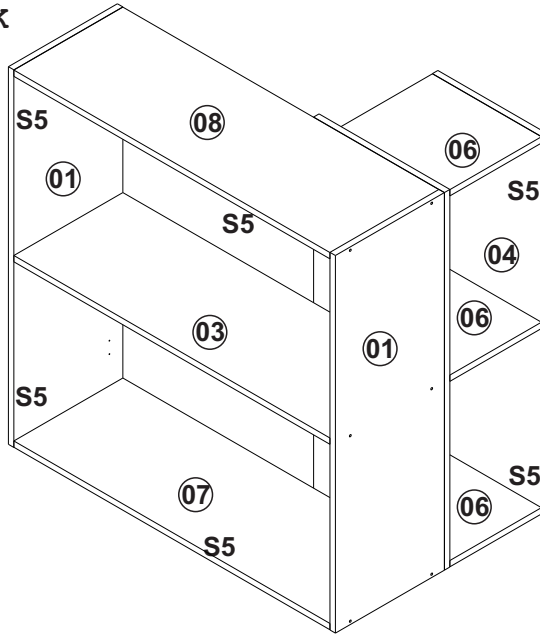
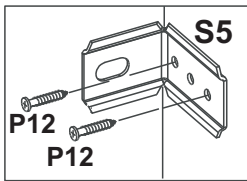

## 11°



Direita  
Right  
Derecha

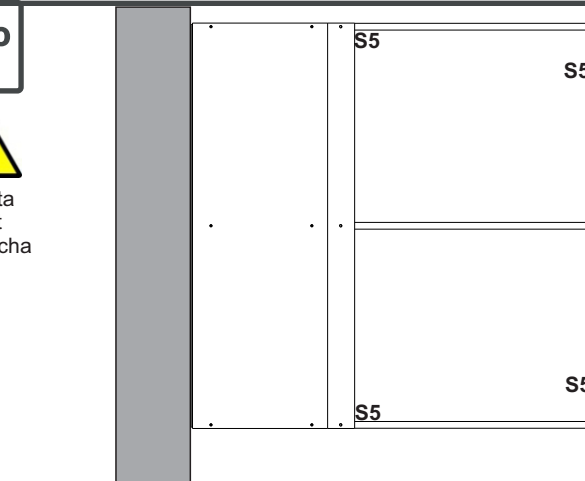

FIXAÇÃO NA PAREDE/ FIJACIÓN EN LA PARED/ FIXING ON THE WALL

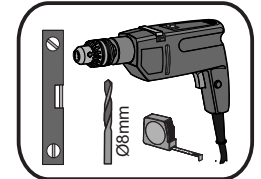
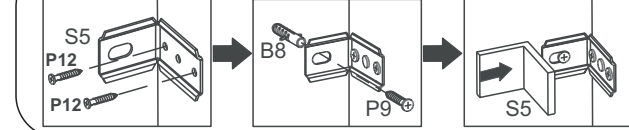

## 10° COSTA/REVÉS/BACK



Direita  
Right  
Derecha

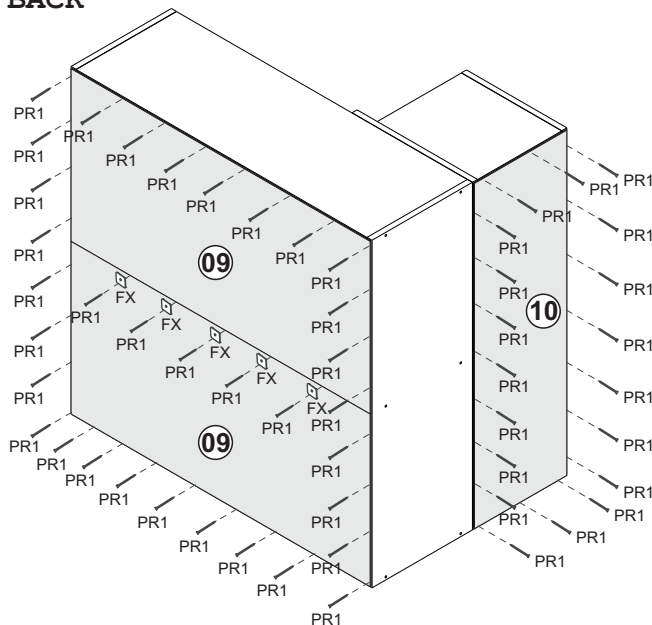
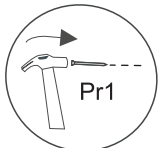

## 08°



Direita  
Right  
Derecha

\*PESO SOPORTADO.  
\*PESO SOPORTADO.  
\*WEIGHT SUPPORTED.

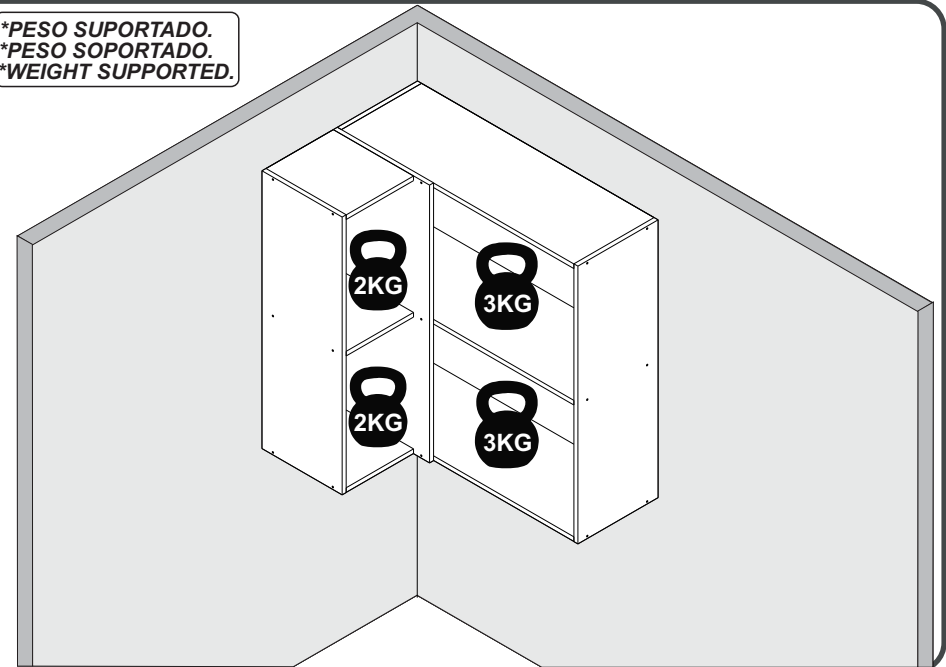

# CO14101 - AÉREO CANTO RETO

Manual de Montagem  
Assembly Instructions  
Instrucción de Montaje

decibal<sup>®</sup>  
móveis

12°



Direita  
Right  
Derecha

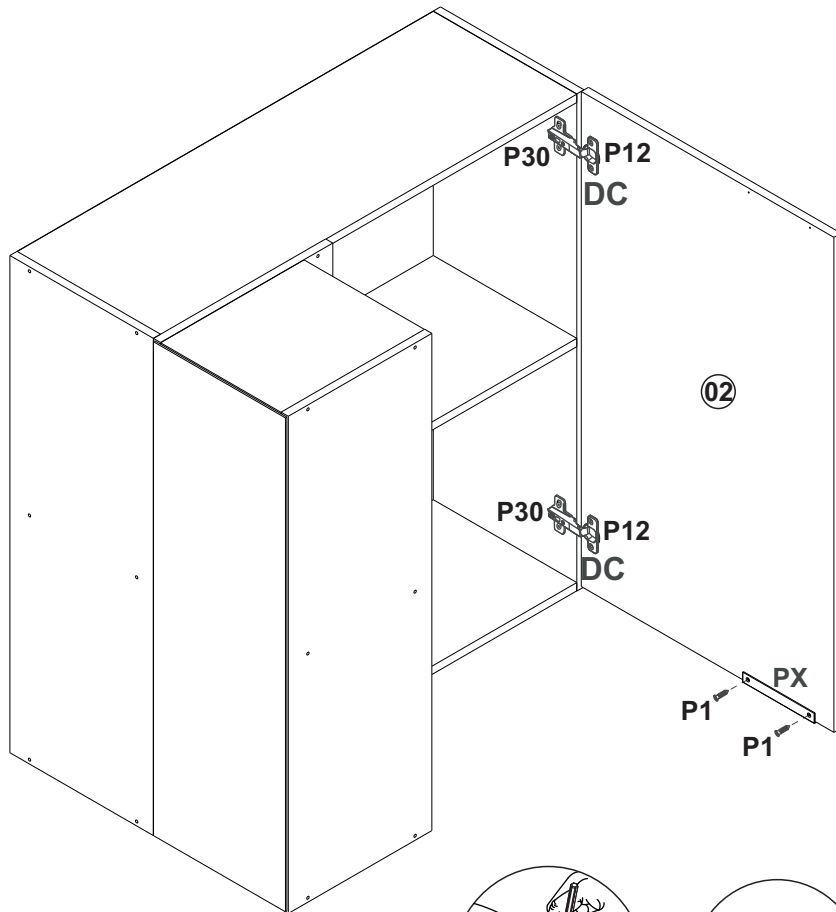

**ATENÇÃO!!!!**

MARCAÇÃO PRA O PRIMEIRO FURO DO PUXADOR  
MARCADO PARA EL PRIMER AGUJERO  
MARKING FOR THE FIRST HANDLE HOLE

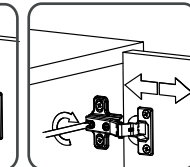
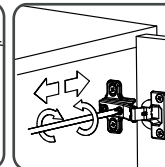
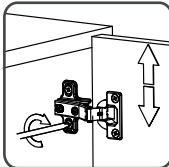
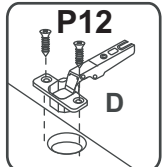
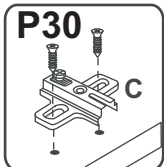
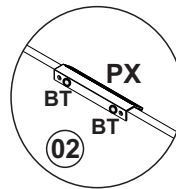

## Relação de Peças/ Relación de Piezas/Parts List

N°	CÓDIGO/CODE	DESCRIÇÃO/DESCRIPCIÓN/DESCRIPTION	QTD/CANT	VOL.
1	0560906	LATERAL/LATERAL/SIDE	2	1
2	0560912	PORTA/PUERTA/DOOR	1	1
3	0560908	PRATELEIRA MAIOR/ESTANTE/SHELF	1	1
4	0560910	LATERAL AFAST DIR/LATERAL/SIDE	1	1
5	0560909	LATERAL AFAST ESQ/LATERAL/SIDE	1	1
6	0560911	BASE	3	1
7	0560905	BASE INF	1	1
8	0560907	BASE SUP	1	1
9	0560913	COSTA MAIOR/REVÉS/BACK	2	1
10	0560914	COSTA MENOR/REVÉS/BACK	1	1

www.decibal.com.br

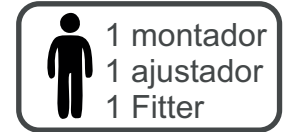
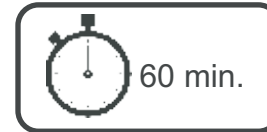

**ATENÇÃO!!!! montadores e consumidores**  
\* Ajustar o torque da parafusadeira para não danificar as peças escareando o parafuso \*  
**ATENCIÓN!!!! montadores e consumidores**  
\* Ajuste el torque del destornillador para no dañar las piezas avallanando el tornillo \*  
**ATTENTION!!!! assemblers and consumers**  
\* Adjust the torque of the screwdriver so as not to damage the parts by countersinking the screw \*

Ferramentas necessárias  
Necessary tools  
Herramientas necesarias

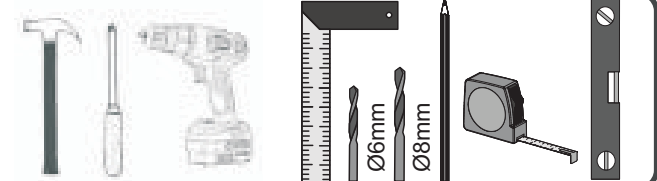

**ATENÇÃO!!!! montadores e consumidores**  
\* Para limpar o móveis utilize somente um pano úmido (umedecido em água pura ou água com sabão neutro). Depois, passe um pano seco. Evite a umidade excessiva.  
\* Evite usar álcool, água sanitária, detergente e outros produtos químicos, mesmo diluídos em água. Não utilize produtos abrasivos de nenhuma espécie

**ATENCIÓN!!!! montadores e consumidores**  
\* Para limpiar el mueble utilice solamente un paño húmedo (humedecido con agua limpia o con un jabón suave). A continuación, utilice un paño seco. Evite el exceso de humedad.  
\* Evite uso de alcohol, hipoclorídrico solución basada, detergente y otros productos químicos, mismo diluidos en agua. No utilice productos abrasivos de ningún tipo.









**ATTENTION!!!! assemblers and consumers**  
\* To clean the furniture, use only a damp cloth (humidify it only in pure water or water and neutral soap). After, use a dry cloth. Avoid excessive humidity.  
\* Avoid using alcohol, bleach, detergent and other chemical products, even diluted in water. Do not use any kind of abrasive cleaning agents to clean the furniture.  
The use of such products may jeopardize the final characteristics of the furniture.

# CO14101 - AÉREO CANTO RETO









Manual de Montagem  
Assembly Instructions  
Instrucción de Montaje

**decibal**<sup>®</sup>  
móveis

## Ferragens/ Herrajes/ Hardware

		escala (1:1)	
LEGENDA	DESCRIÇÃO/DESCRIPCIÓN/DESCRIPTION	CÓDIGO	QUANT.
<b>P7</b>	 PARAFUSO/TORNILLO/SCREW 4X45	01318	<b>24</b>
<b>PR1</b>	 PREGO/CLAVO/NAIL 10X10	01330	<b>80</b>
<b>C2</b>	 CAVILHA/TARUGO/DOWEL 6X30 MM	01211	<b>26</b>
<b>P1</b>	 PARAFUSO/TORNILLO/SCREW 3,5X12	01328	<b>02</b>
<b>PU</b>	 PARAFUSO UNIÃO/UNIÓN DETORNILLO /SCREW UNION	01495	<b>02</b>
<b>P12</b>	 PARAFUSO/TORNILLO/SCREW 3,5X13	09927	<b>20</b>
<b>P9</b>	 PARAFUSO/TORNILLO/SCREW 6X50	03827	<b>06</b>
<b>P14</b>	 PARAFUSO/TORNILLO/SCREW 3,5X35	11871	<b>07</b>
<b>P30</b>	 PARAFUSO/TORNILLO/SCREW 4X16	12291	<b>04</b>

## escala (N/A)

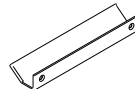
LEGENDA	DESCRIÇÃO/DESCRIPCIÓN/DESCRIPTION	CÓDIGO	QUANT.
<b>CL</b>	 COLA/PEGAMENTO/GLUE	01213	<b>01</b>
<b>ET</b>	 ETIQUETA LOGO DECIBAL/LABEL DECIBAL	01312	<b>01</b>
<b>B1</b>	 BUCHA/BUJE/BUCHING ( 8mm)	01311	<b>06</b>
<b>DC</b>	 DOBRADIÇA/BISAGRA/HINGE 35MM / 165°CURVA	04128	<b>02</b>
<b>S5</b>	 SUPORTE AÉREO/APOYO AÉREO/AIR SUPPORT	03828 EBANO 04501	<b>06</b>
<b>FX</b>	 FIXADOR COSTA/FIJADOR FONDO/FIXER COAST	01331	<b>09</b>
<b>AD</b>	ADESIVO/ADHESIVO/ADHESIVE 	WENGUE 12623	<b>26</b>
<b>BT</b>	 BATENTE/BATIENTE DE SILICONA/SILICONE STOP 8MM	02921	<b>02</b>
<b>PX</b>	 PUXADOR/PEGADOR /HANDLE CHAMPANHE( AKEO 128MM)	12611	<b>01</b>

Medida em mm

