

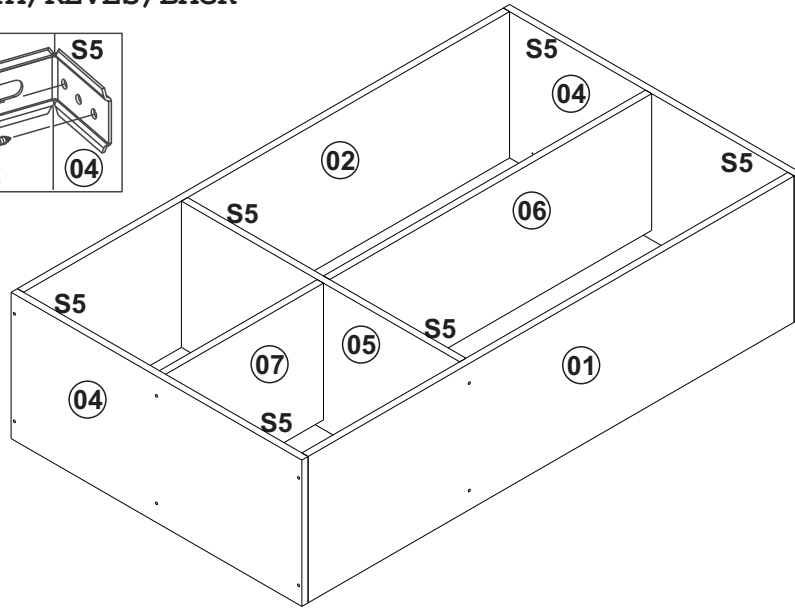

4º

COSTA/REVÉS/BACK

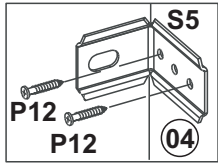

Fixação parede  
 Fixed in the wall

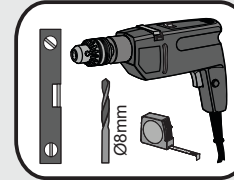
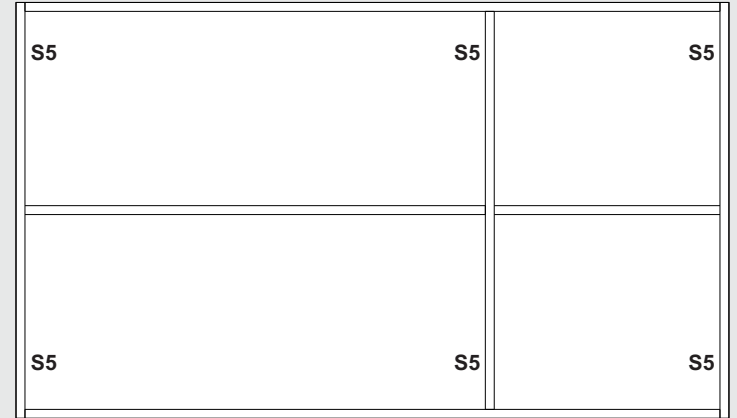
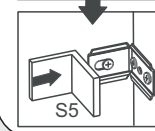
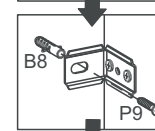
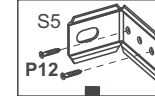

6º

COSTA/REVÉS/BACK

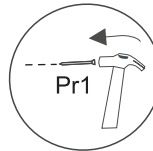
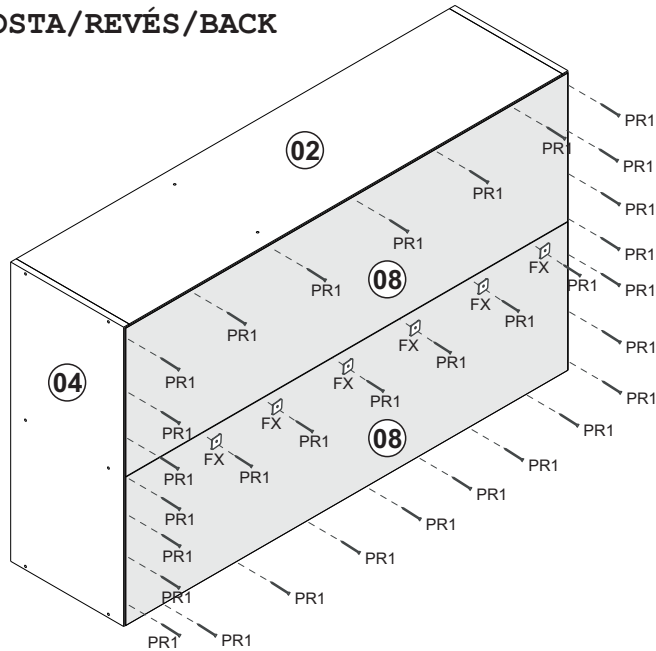

PESO SUPORTADO/PESO SOPORTADO/ WEIGHT SUPPORTED

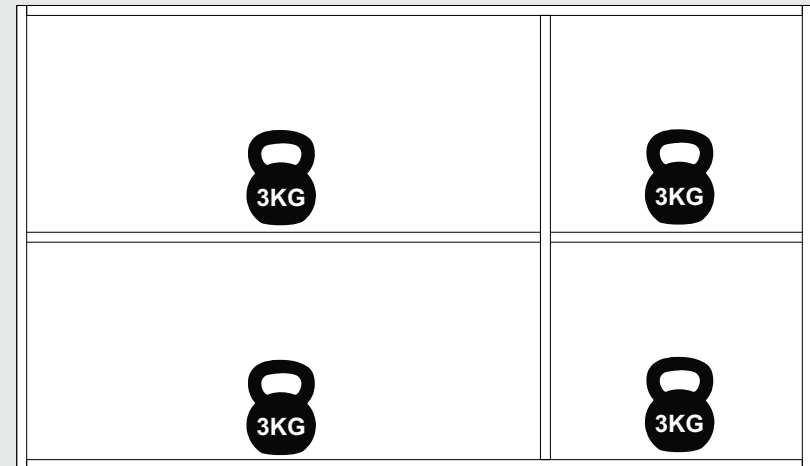

14°

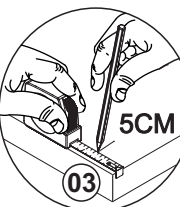
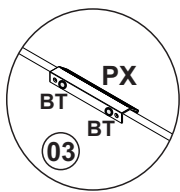
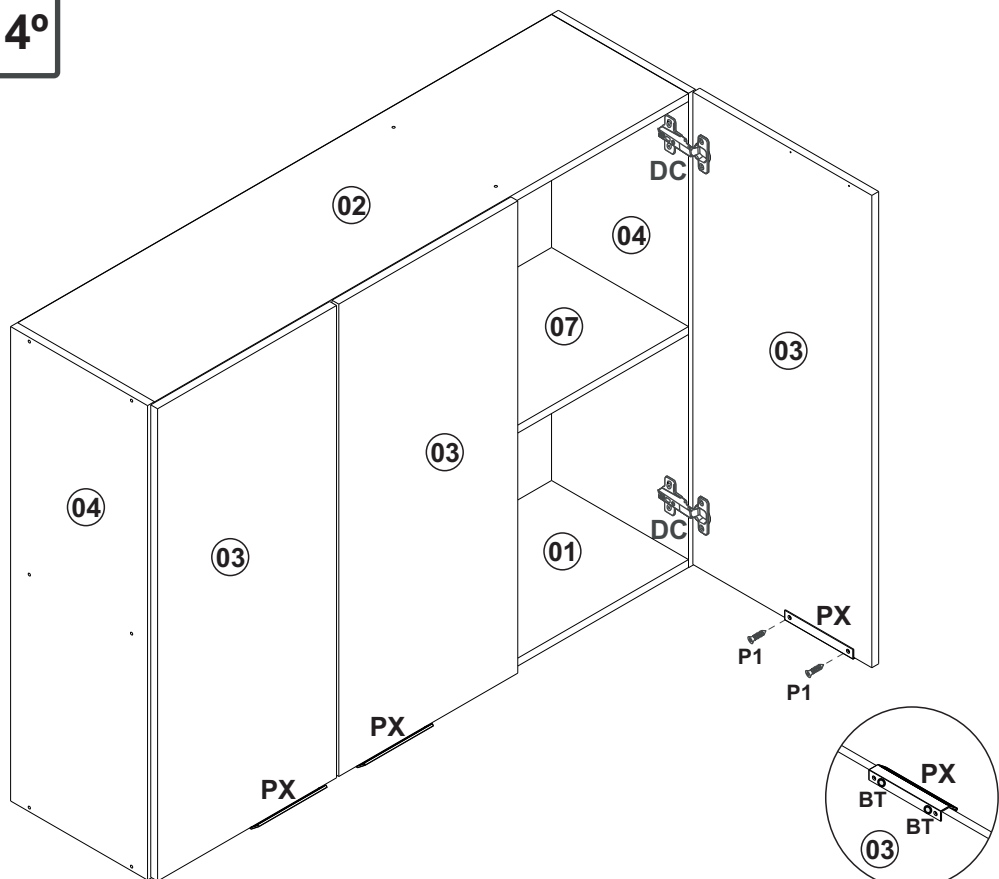

**ATENÇÃO!!!!**

MARCAÇÃO PRA O PRIMEIRO FURO DO PUXADOR  
MARCADO PARA EL PRIMER AGUJERO  
MARKING FOR THE FIRST HANDLE HOLE

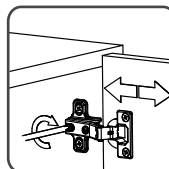
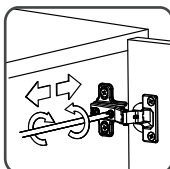
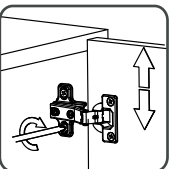
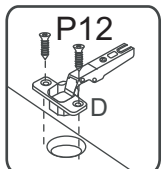
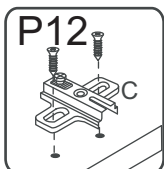

## Relação de Peças/ Relación de Piezas/Parts List

N°	CÓDIGO/ CODE	DESCRIÇÃO/ DESCRIPCIÓN/ DESCRIPTION	QTD/ CANT	VOL.	
1	0560925	BASE INF	1170X300X15MM	1	1
2	0560927	BASE SUP	1170X300X15MM	1	1
3	0560931	PORTA/ PUERTA/ DOOR	896X392X15MM	3	1
4	0560926	LATERAL/ LATERAL/ SIDE	900X300X15MM	2	1
5	0560929	DIVISORIA/ DIVIDER	869X300X15MM	1	1
6	0560928	PRATELEIRA/ ESTANTE/ SHELF	775X300X15MM	1	1
7	0560930	PRATELEIRA MENOR/ ESTANTE/ SHELF	380X300X15MM	1	1
8	0560932	COSTA/ REVÉS/ BACK	1194X447X2, 8MM	2	1

www.decibal.com.br

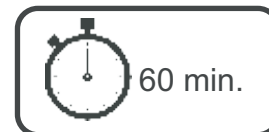

**ATENÇÃO!!!! montadores e consumidores**  
\* Ajustar o torque da parafusadeira para não danificar as peças escareando o parafuso \*  
**ATENCIÓN!!!! montadores e consumidores**  
\* Ajuste el torque del destornillador para no dañar las piezas avallando el tornillo \*  
**ATTENTION!!!! assemblers and consumers**  
\* Adjust the torque of the screwdriver so as not to damage the parts by countersinking the screw \*

Ferramentas necessárias  
Necessary tools  
Herramientas necesarias

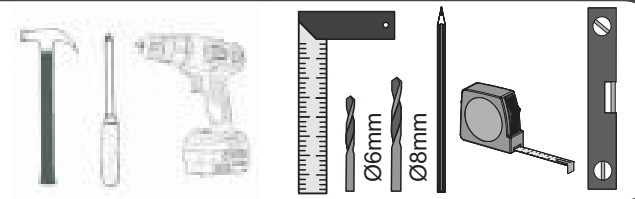









**ATENÇÃO!!!! montadores e consumidores**  
\* Para limpar o móveis utilize somente um pano úmido (umedecido em água pura ou água com sabão neutro). Depois, passe um pano seco. Evite a umidade excessiva.  
\* Evite usar álcool, água sanitária, detergente e outros produtos químicos, mesmo diluídos em água. Não utilize produtos abrasivos de nenhuma espécie









**ATENCIÓN!!!! montadores e consumidores**  
\* Para limpiar el mueble utilice solamente un paño húmedo (humedecido con agua limpia o con un jabón suave).  
A continuación, utilice un paño seco. Evite el exceso de humedad.  
\* Evite uso de alcohol, hipoclorido solución basada, detergente y otros productos químicos, mismo diluidos en agua. No utilice productos abrasivos de ningún tipo.

**ATTENTION!!!! assemblers and consumers**  
\*To clean the furniture, use only a damp cloth (humidify it only in pure water ou water and neutral soap).After, use a dry cloth.Avoid excessive humidity.  
\*Avoid using alcohol, bleach, detergent and other chemical products, even diluted in water. Do not use any kind of abrasive cleaning agents to clean the furniture.  
The use of such products may jeopardize the ?nal characteristics of the furniture.

## Ferragens/ Herrajes/ Hardware

		escala (1:1)	
LEGENDA	DESCRIÇÃO/DESCRIPCIÓN/DESCRIPTION	CÓDIGO	QUANT.
<b>P7</b>	 PARAFUSO/TORNILLO/SCREW 4X45	01318	<b>18</b>
<b>PR1</b>	 PREGO/CLAVO/NAIL 10X10	01330	<b>68</b>
<b>C2</b>	 CAVILHA/TARUGO/DOWEL 6X30 MM	01211	<b>18</b>
<b>P1</b>	 PARAFUSO/TORNILLO/SCREW 3,5X12	01328	<b>06</b>
<b>PU</b>	 PARAFUSO UNIÃO/UNIÓN DETORNILLO /SCREW UNION	01495	<b>02</b>
<b>P12</b>	 PARAFUSO/TORNILLO/SCREW 3,5X13	09927	<b>48</b>
<b>C3</b>	 CAVILHA/TARUGO/DOWEL 6X50 MM	01212	<b>02</b>
<b>P9</b>	 PARAFUSO/TORNILLO/SCREW 6X50	03827	<b>06</b>

## escala (N/A)

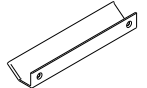
LEGENDA	DESCRIÇÃO/DESCRIPCIÓN/DESCRIPTION	CÓDIGO	QUANT.
<b>CL</b>	 COLA/PEGAMENTO/GLUE	01213	<b>01</b>
<b>ET</b>	 ETIQUETA LOGO DECIBAL/LABEL DECIBAL	01312	<b>01</b>
<b>B1</b>	 BUCHA/BUJE/BUCHING	01311	<b>06</b>
<b>DC</b>	 DOBRADIÇA/BISAGRA/HINGE D=35mm C=Alta (AMORTECIMENTO)	12615	<b>06</b>
<b>S5</b>	 SUPORTE AÉREO/APOYO AÉREO/AIR SUPPORT EBANO 04501	03828	<b>06</b>
<b>FX</b>	 FIXADOR COSTA/FIJADOR FONDO/FIXER COAST	01331	<b>09</b>
<b>AD</b>	 ADESIVO/ADHESIVO/ADHESIVE Wengue 12623		<b>16</b>
<b>BT</b>	 BATENTE/BATIENTE DE SILICONA/SILICONE STOP 8MM	02921	<b>06</b>
<b>PX</b>	 PUXADOR/PEGADOR /HANDLE CHAMPANHE( AKEO 128MM)	12611	<b>03</b>

Medida em mm

