

CO14400 - AÉREO 1,20 M

Manual de Montagem
Assembly Instructions
Instrucción de Montaje

decibal[®]
móveis

Produto Montado
Producto final
Assembled

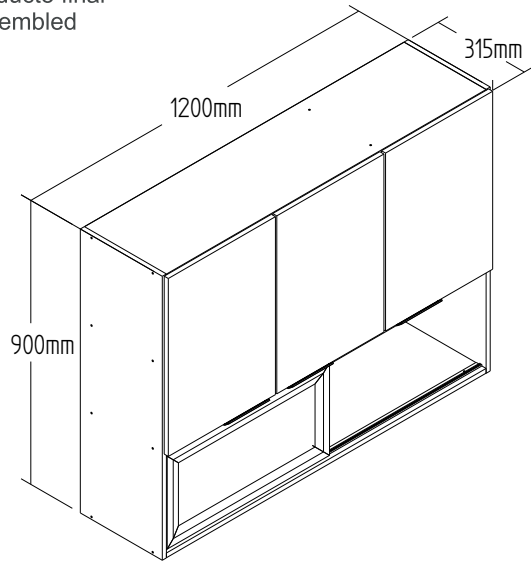

01°

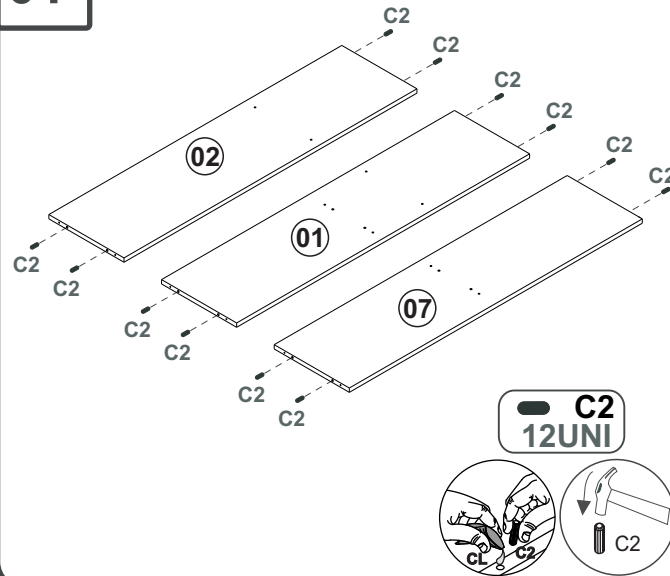

02°

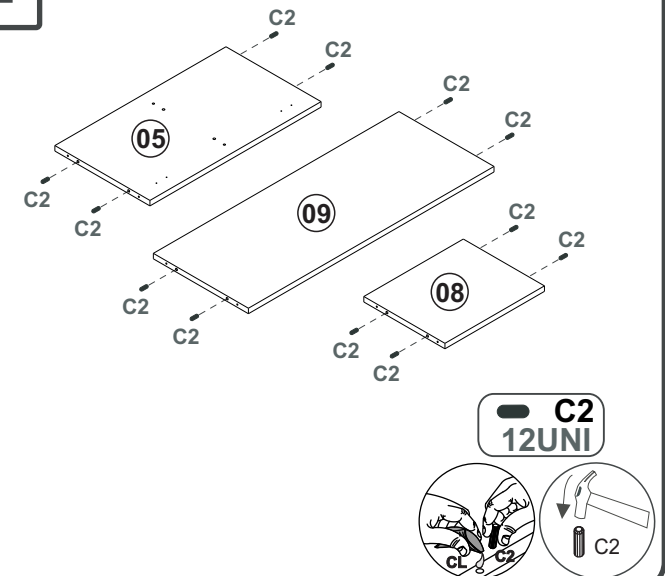

3°

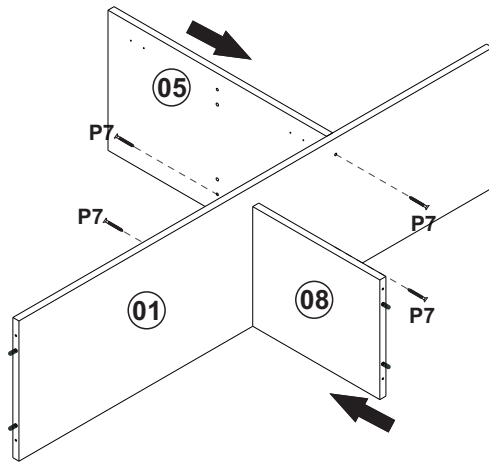

P7 4 UNI



4°

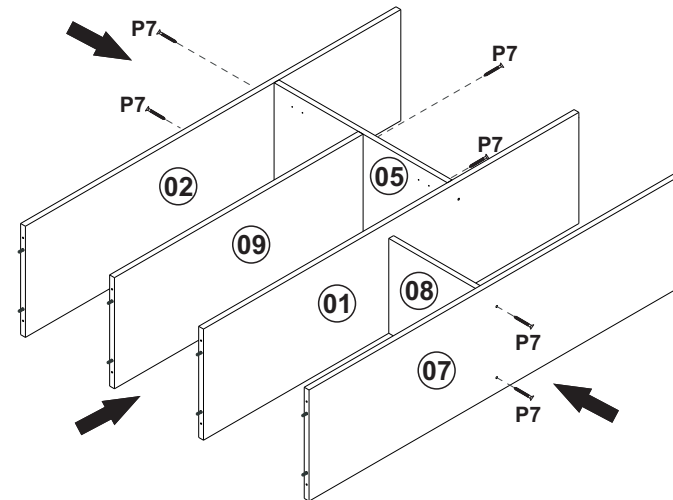

P7 6 UNI



5°

P7 14 UNI

7° COSTA/REVÉS/BACK

S5 P12

6°

01 2cm

07 2,2cm

ATENÇÃO!!!!
 MARCAÇÃO PRA O TRILHO
 MARCADO PARA EL RIEL
 MARKING FOR THE RAIL

8° COSTA/REVÉS/BACK

PR1

CO14400 - AÉREO 1,20 M

Manual de Montagem
Assembly Instructions
Instrucción de Montaje

decibal[®]
móveis

9°

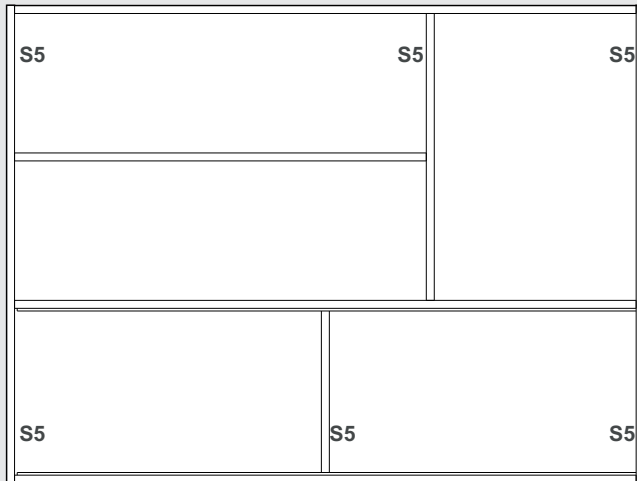

Fixação parede
Fixed in the wall

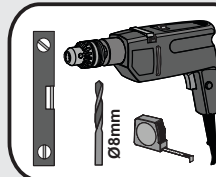
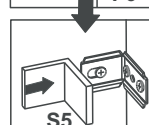
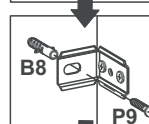
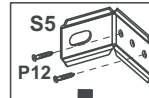

11°

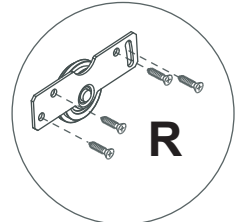
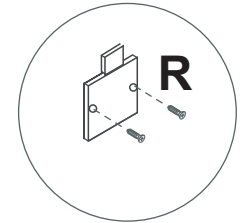
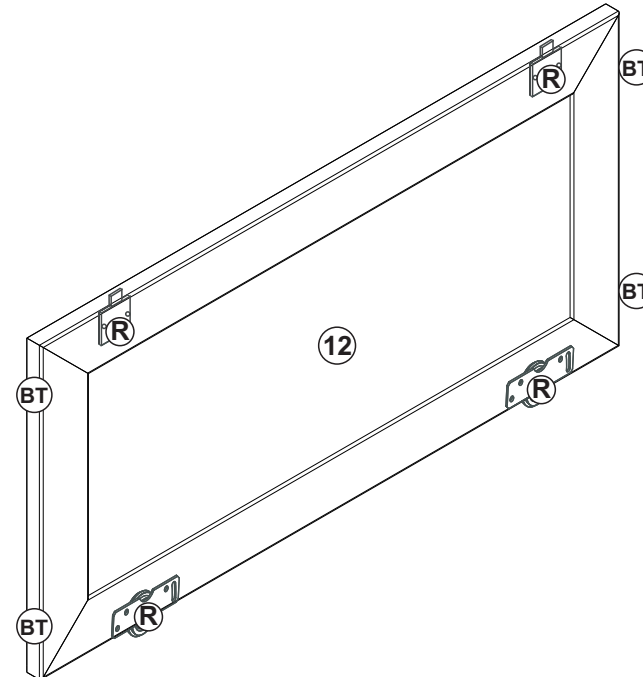

10°



*PESO SUPORTADO.
*PESO SOPORTADO.
*WEIGHT SUPPORTED.

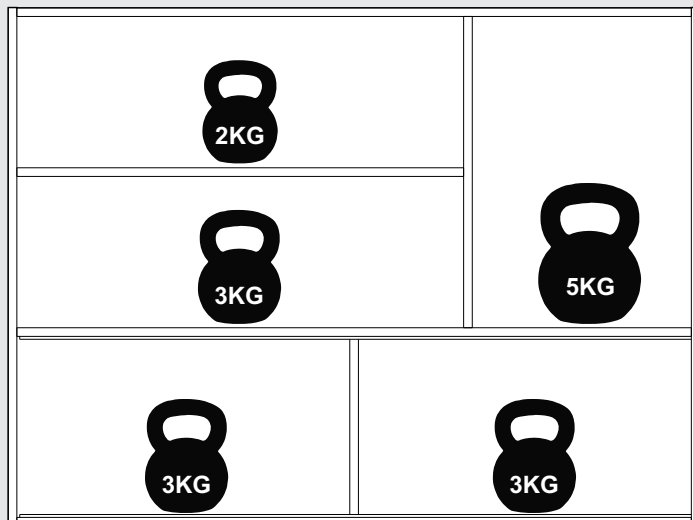

www.decibal.com.br

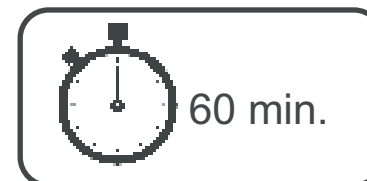

12°

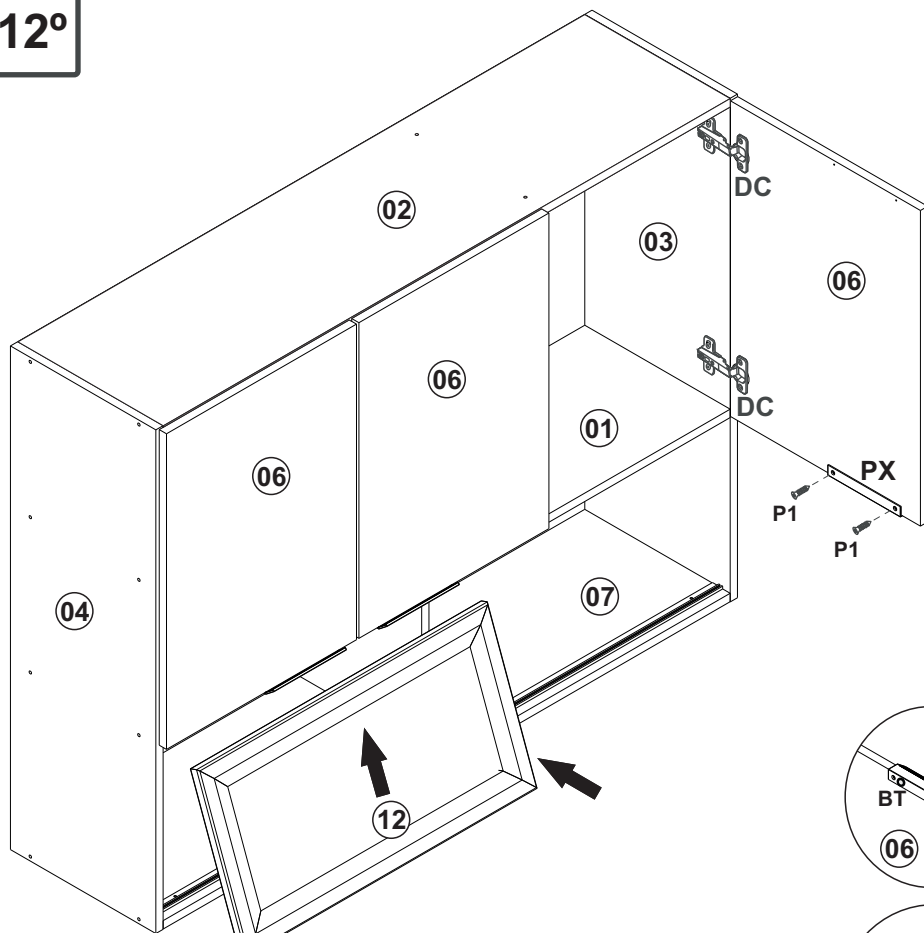

ATENÇÃO!!!!
MARCAÇÃO PRA O PRIMEIRO FURO DO PUXADOR
MARCADO PARA EL PRIMER AGUJERO
MARKING FOR THE FIRST HANDLE HOLE

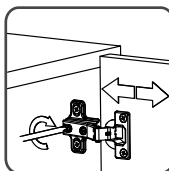
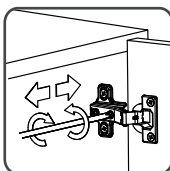
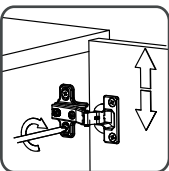
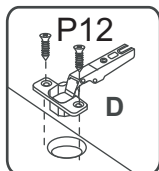
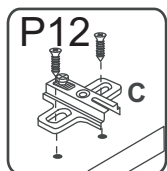
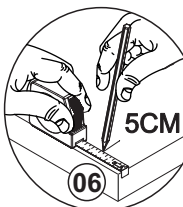
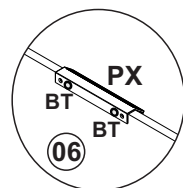

Relação de Peças/ Relación de Piezas/Parts List

N°	CÓDIGO/CODE	DESCRIÇÃO/DESCRIPCIÓN/DESCRIPTION	QTD/CANT	VOL.
1	0560790	BASE INT	1	1
2	0560789	BASE SUP	1	1
3	0560787	LATERAL DIR/LATERAL/SIDE	1	1
4	0560788	LATERAL ESQ/LATERAL/SIDE	1	1
5	0560791	DIVISORIA SUP/DIVIDER	1	1
6	0560793	PORTA/PUERTA/DOOR	3	1
7	0560786	BASE INF	1	1
8	0560792	DIVISORIA INF/DIVIDER	1	1
9	0560794	PRATELEIRA/ESTANTE/SHELF	1	1
10	0560796	COSTA SUP/REVÉS/BACK	1	1
11	0560795	COSTA INF/REVÉS/BACK	1	1
12	12449	PORTA MOLDURA/PUERTA/DOOR	1	1

ATENÇÃO!!!! montadores e consumidores
* Ajustar o torque da parafusadeira para não danificar as peças escareando o parafuso *
ATENCIÓN!!!! montadores e consumidores
* Ajuste el torque del destornillador para no dañar las piezas avallando el tornillo *
ATTENTION!!!! assemblers and consumers
* Adjust the torque of the screwdriver so as not to damage the parts by countersinking the screw *

Ferramentas necessárias
Necessary tools
Herramientas necesarias

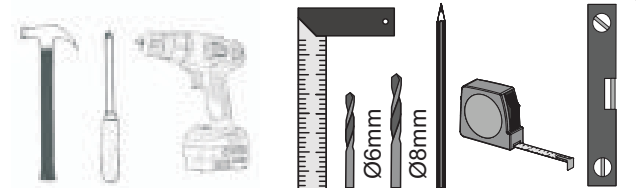

ATENÇÃO!!!! montadores e consumidores
* Para limpar o móveis utilize somente um pano úmido (umedecido em água pura ou água com sabão neutro). Depois, passe um pano seco. Evite a umidade excessiva.
* Evite usar álcool, água sanitária, detergente e outros produtos químicos, mesmo diluídos em água. Não utilize produtos abrasivos de nenhuma espécie

ATENCIÓN!!!! montadores e consumidores
* Para limpiar el mueble utilice solamente un paño húmedo (humedecido con agua limpia o con un jabón suave).
A continuación, utilice un paño seco. Evite el exceso de humedad.
* Evite uso de alcohol, hipoclorido solución basada, detergente y otros productos químicos, mismo diluidos en agua. No utilice productos abrasivos de ningún tipo.







ATTENTION!!!! assemblers and consumers
* To clean the furniture, use only a damp cloth (humidify it only in pure water or water and neutral soap). After, use a dry cloth. Avoid excessive humidity.
* Avoid using alcohol, bleach, detergent and other chemical products, even diluted in water. Do not use any kind of abrasive cleaning agents to clean the furniture.
The use of such products may jeopardize the final characteristics of the furniture.

CO14400 - AÉREO 1,20 M

Manual de Montagem
Assembly Instructions
Instrucción de Montaje

decibal[®]
móveis







Ferragens/ Herrerajes/ Hardware

		escala (1:1)	
LEGENDA	DESCRIÇÃO/DESCRIPCIÓN/DESCRIPTION	CÓDIGO	QUANT.
P7	 PARAFUSO/TORNILLO/SCREW 4X45	01318	24
PR1	 PREGO/CLAVO/NAIL 10X10	01330	66
C2	 CAVILHA/TARUGO/DOWEL 6X30 MM	01211	26
P1	 PARAFUSO/TORNILLO/SCREW 3,5X12	01328	14
PU	 PARAFUSO UNIÃO/UNIÓN DETORNILLO /SCREW UNION	01495	02
P12	 PARAFUSO/TORNILLO/SCREW 3,5X13	09927	48
P9	 PARAFUSO/TORNILLO/SCREW 6X50	03827	06

escala (N/A)

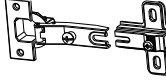
LEGENDA	DESCRIÇÃO/DESCRIPCIÓN/DESCRIPTION	CÓDIGO	QUANT.
R	 2X 2X 6X ROLDANA CIV CORR C2 (1 PT)	07387	01

escala (N/A)

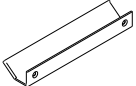
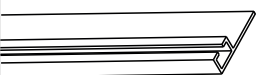
LEGENDA	DESCRIÇÃO/DESCRIPCIÓN/DESCRIPTION	CÓDIGO	QUANT.
CL	 COLA/PEGAMENTO/GLUE	01213	01
ET	 ETIQUETA LOGO DECIBAL/LABEL DECIBAL	01312	01
B1	 BUCHA/BUJE/BUCHING (8mm)	01311	06
DC	 D C DOBRADIÇA/BISAGRA/HINGE D=35mm C=Alta Amortecimento	12615	06
S5	 SUPORTE AÉREO/APOYO AÉREO/AIR SUPPORT EBANO 04501	03828	06
FX	 FIXADOR COSTA/FIJADOR FONDO/FIXER COAST	01331	08
AD	ADESIVO/ADHESIVO/ADHESIVE  Wengue 12623		16
BT	 BATENTE/BATIENTE DE SILICONA/SILICONE STOP 8MM	02921	10
PX	 PUXADOR/PEGADOR /HANDLE CHAMPANHE(AKEO 128MM)	12611	03
TR	 TRILHO/TRILLO/RAIL 1164mm	12631	02

Medida em mm

