

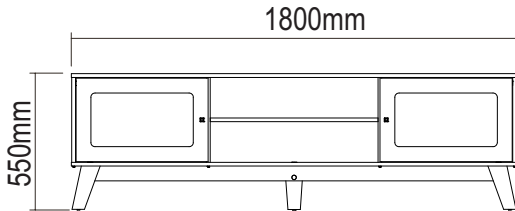

Rack Charlotte

Rack Charlotte / Charlotte Rack

Versão 1.0 / Versión 1.0 / Version 1.0

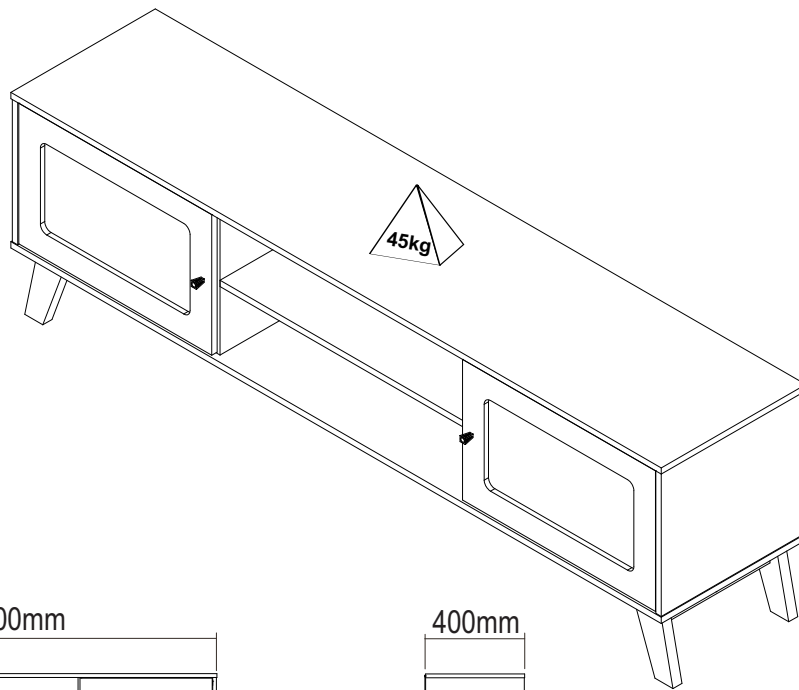

frente/frente/front

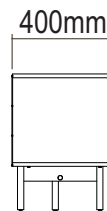

lateral/lado/side

Conservação e Limpeza - Conservación y Limpieza - Conservation and Cleaning

Não expor o produto ao sol, altas temperaturas e umidade. Não arrastar objetos sobre a superfície do móvel (ex.: TV, DVD, aparelho de som, objetos decorativos...) e manter em local seco e arejado. Para a limpeza, utilizar um pano seco e macio. Não é necessário o uso de materiais abrasivos ou álcool.

No exponga el producto a la luz solar, las altas temperaturas y la humedad. No arrastre los objetos a través de la superficie de la unidad (por ejemplo, TV, DVD, equipo de música, objetos de decoración ...) Mantener en un lugar fresco y seco. Para la limpieza, utilizar un paño seco y suave. El uso de materiales abrasivos o del alcohol no es necesario.

Do not expose the product to sunlight, high temperatures and humidity. Do not drag objects across the surface of the unit (TV, DVD, stereo, decorative objects ...) keep it in a cool dry place. For cleaning, use a dry and soft cloth. Do not use abrasive materials or alcohol.

Garantia

Este certificado de Garantia é uma vantagem adicional oferecida ao consumidor, porém para que o mesmo tenha validade é imprescindível que seja apresentada a NOTA FISCAL de compra do produto.

Com este produto, a Artely tem como objetivo atender plenamente o proprietário-consumidor, proporcionando a garantia na forma aqui estabelecida, pelo período de três meses a partir da data da nota fiscal de compra. A Artely restringe a sua responsabilidade à substituição gratuita das peças defeituosas, em caso de defeitos ou avarias devidamente constatados como sendo de fabricação, durante a vigência desta garantia.

A Artely declara a garantia nula e sem efeito se o produto for alterado, adulterado, molhado ou consertado e ainda pela prática de montagem inadequada ou mau uso. Também será considerada nula em casos de força maior, como aqueles causados por agentes da Natureza (chuvas, incêndios, excesso de umidade, cupins,...) e eventos externos como objetos arrastados sobre a superfície do móvel (ex.: TV, DVD, aparelho de som, objetos decorativos...).

Para exercer seus direitos de comprador é importante que antes de montar seu produto você leia com atenção as instruções de cada passo do manual de montagem que acompanha o móvel.

Caso o produto não esteja em conformidade, entre em contato com a loja onde efetuou a compra e faça sua reclamação, apontando os defeitos técnicos observados. Para agilizar o seu atendimento, tenha sempre em mãos o manual de montagem com os respectivos números das peças defeituosas, conforme descritas no manual.

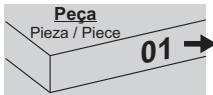



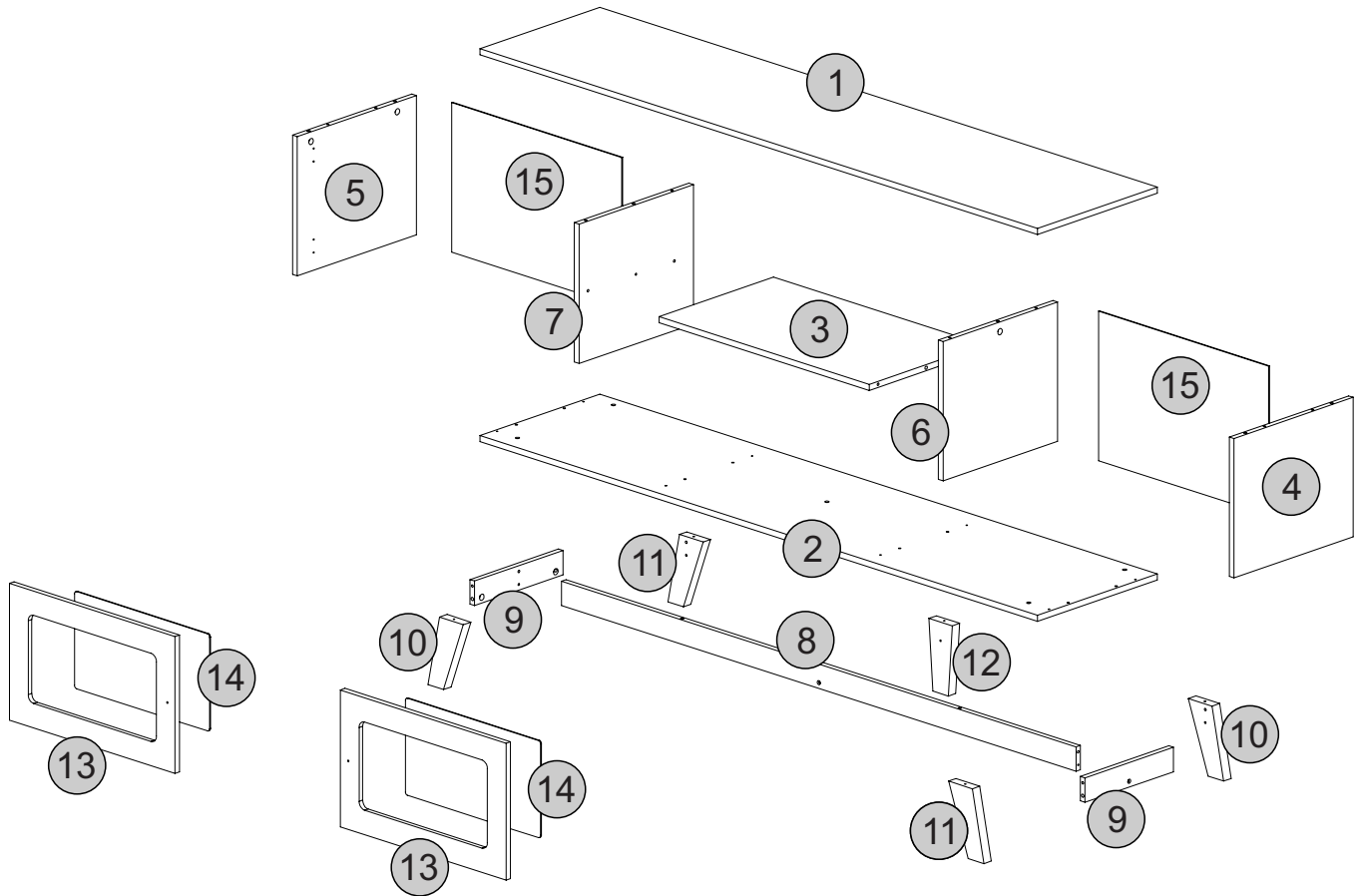
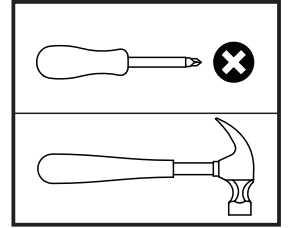





- O número na borda da peça corresponde ao manual.
- Para retirada do número usar Lustra-Móveis, Alcool em Gel ou Borracha.
- El número en el borde de la pieza coincide con el manual.
- Use una goma de borrar blanca, alcohol en gel o lustrador para muebles para eliminar los números.
- The number on the edge of the piece matches the manual.
- Use a White eraser, Alcohol Gel or Furniture Polish to remove the numbers.

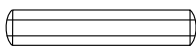
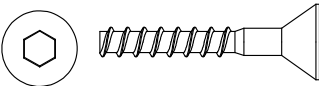
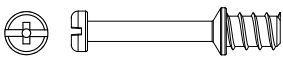
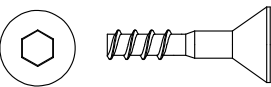
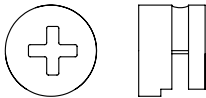
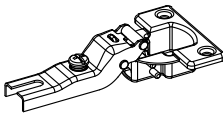

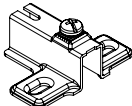
Descrição	Descripción	Description	Qty
1-Tampo (1800x400x15mm)	1-Tapa	1-Top	1
2-Base (1800x400x15mm)	2-Base	2-Base	1
3-Prateleira Fixa (678x382x15mm)	3-Fixed Shelf	3-Estante Fijo	1
4-Lateral Direita (343x398x15mm)	4-Lado izquierdo	4-Left side	1
5-Lateral Esquerda (343x398x15mm)	5-Lado derecho	5-Right side	1
6-Divisão Direita (343x382x15mm)	6-División derecho	6-Right Division	1
7-Divisão Esquerda (343x382x15mm)	7-División izquierdo	7-Left Division	1
8-Travessa Inferior (1660x60x15)	8-Bottom Crossbar	8-Travesaño inferior	1
9-Travessa dos Pés (295x60x15mm)	9-Foot Rail	9-Riel de Pie	2
10-Pé Esquerdo (180x77x15mm)	10-Left Foot	10-Pie Izquierdo	2
11-Pé Direito (180x77x15mm)	11-Right Foot	11-Pie Derecho	2
12-Pé Central (180x75x15mm)	12-Center Foot	12-Pie central	1
13-Porta (534x337x15mm)	13-Door	13-Puerta	2
14-Almofada (436x239x3mm)	14-Pillow	14-Almohada	2
15-Traseiro (549x368x3mm)	15-Rear	15-Trasero	2

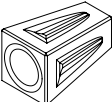
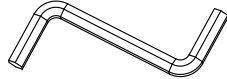
Lista de Materiais

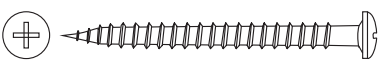
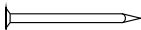
Lista de Materiales/ Hardware List

A		Cavilha / Tarugo / Dowel Ø6x30mm	26	I		Parafuso / Tornillo / Screw Ø5,0x40mm cab 10	07
B		Minifix / Minifix / Minifix Ø7x30mm	14	J		Parafuso / Tornillo / Screw Ø5,0x24mm cab 10	01
C		Tambor / Tambor / Minifix Cam Ø15x12mm	14	K		Dobradiça / Bisagra / Hinge	04
D		Tapa furo adesivo / Adhesivo / Hole Cover Ø18mm	20	L		Calço Dobradiça / Cuña de Bisagra / Hinge Shim	04
E		Parafuso Tornillo / Screw Ø4x14mm CP	36	M		Puxador / Arrancador / Puller	02
F		Chave Zeta / Clave Zeta / Allen Key	01	N		Sapata Fixa / Pata Fija / Fixed Foot Ø5,0x10mm	05
G		Parafuso / Tornillo / Screw / Ø3,5x40mm CP	08	O		Prego / Clavo / Nail 8x8	28
H		Parafuso / Tornillo / Screw / Ø3,5x25mm CF	02	P		Aruela / Aruela / Washer / 12x3	20

DICAS PARA FIXAR MINIFIX

TIP TO FASTEN THE MINIFIX
PISTA PARA ARREGLAR EL MINIFIX

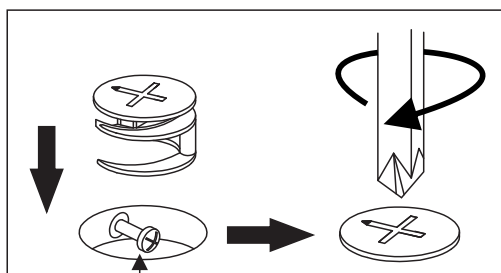

Cabeça do parafuso precisa estar no centro

La cabeza del tornillo debe estar en el centro

Screw head has to be in the center

Parafuso Minifix

Tornillo minifix/Minifix screw

Fixe o parafuso até o ressalto encostar na superfície da peça (veja o exemplo abaixo).

Tighten the screw until its overhang part lean on the piece surface (see the example below).

Fije el tornillo hasta que su parte sobresaliente toque la superficie de la pieza (vea el ejemplo abajo).

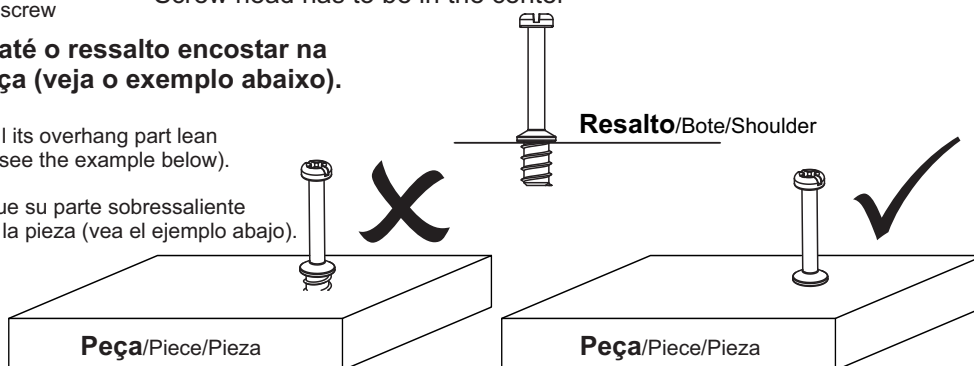

Passo 1

Paso/Step

PEÇA

Pieza/Piece

1 - TAMPO x1

FERRAGEM

Herraje/Hardware

B  06

FERRAMENTA

Herramienta/Tool

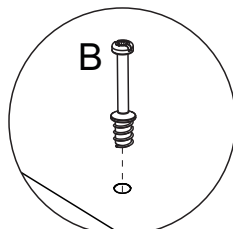
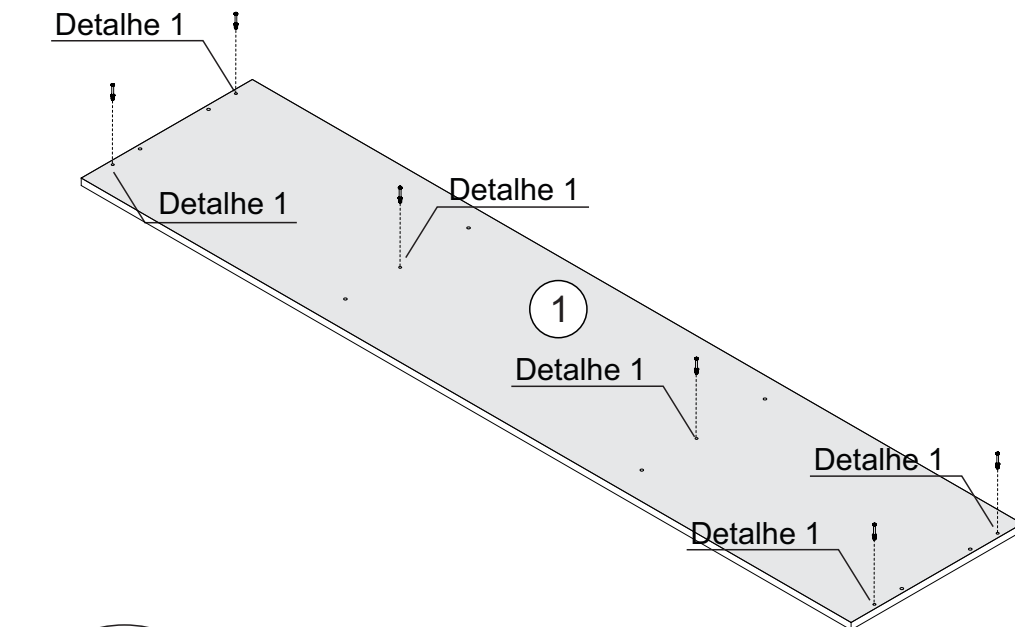
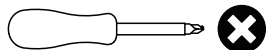

Detalhe 1
Detalle/Detail

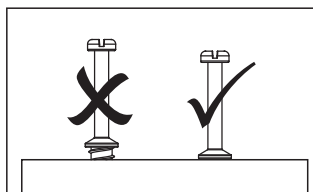

Passo 2

Paso/Step

PEÇA

Pieza/Piece

2 - BASE x1

FERRAMENTA

Herramienta/Tool

B  02

FERRAMENTA

Herramienta/Tool

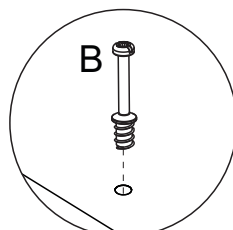
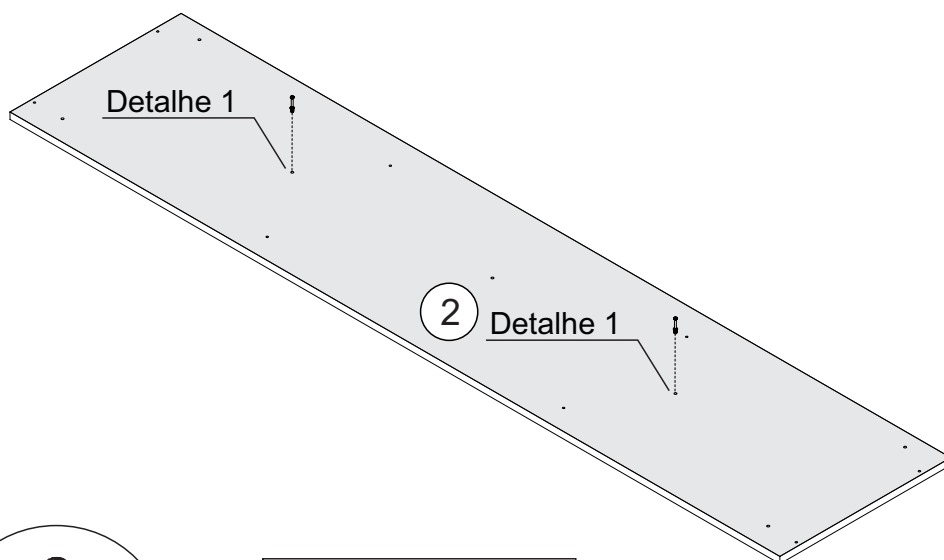
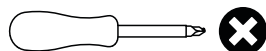

Detalhe 1
Detalle/Detail

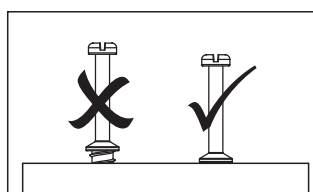

Passo 3

Paso/Step

PEÇA
Pieza/Piece

5 - LATERAL ESQUERDA x1

FERRAGEM
Herraje/Hardware

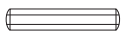
A  04

E  04

L  02

FERRAMENTA
Herramienta/Tool

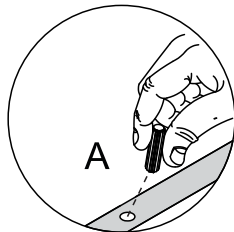
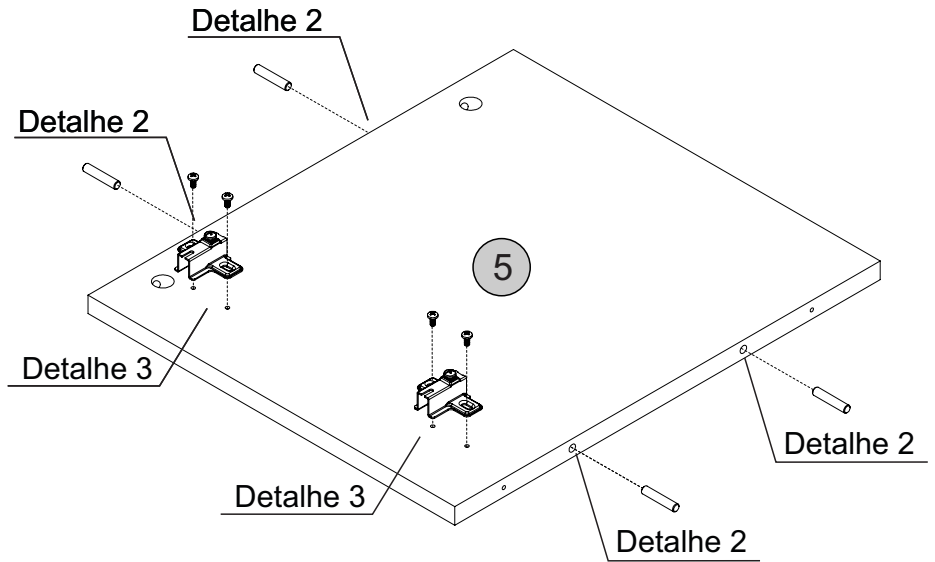
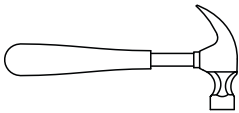
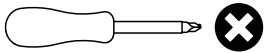

Detalhe 2
Detalle/Detail

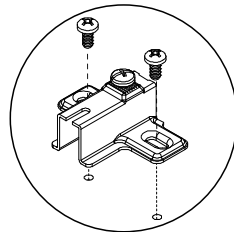

Detalhe 3
Detalle/Detail

Passo 4

Paso/Step

PEÇA
Pieza/Piece

4 - LATERAL DIREITA x1

FERRAGEM
Herraje/Hardware

A  04

E  04

L  02

FERRAMENTA
Herramienta/Tool

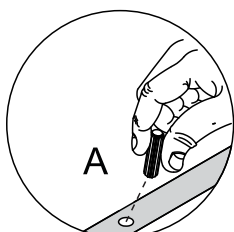
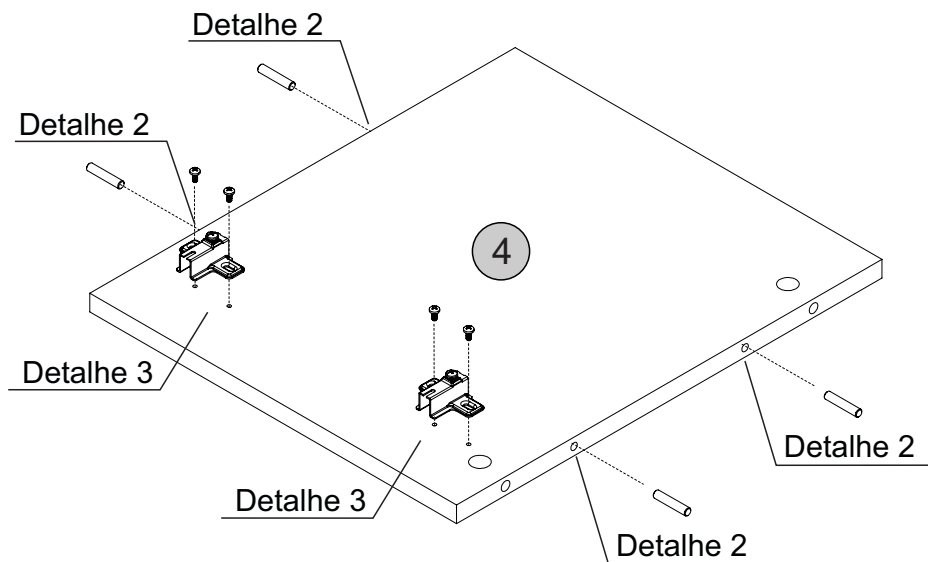
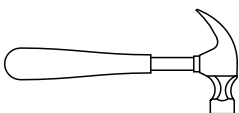
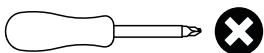

Detalhe 2
Detalle/Detail

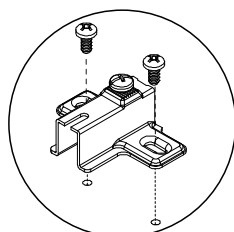

Detalhe 3
Detalle/Detail

Passo 5

Paso/Step

PEÇA
Pieza/Piece

6 - DIVISÃO DIREITA x1

FERRAGEM
Herraje/Hardware

A  04

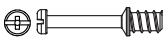
B  01

FERRAMENTA
Herramienta/Tool

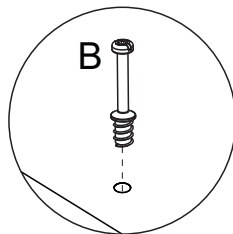
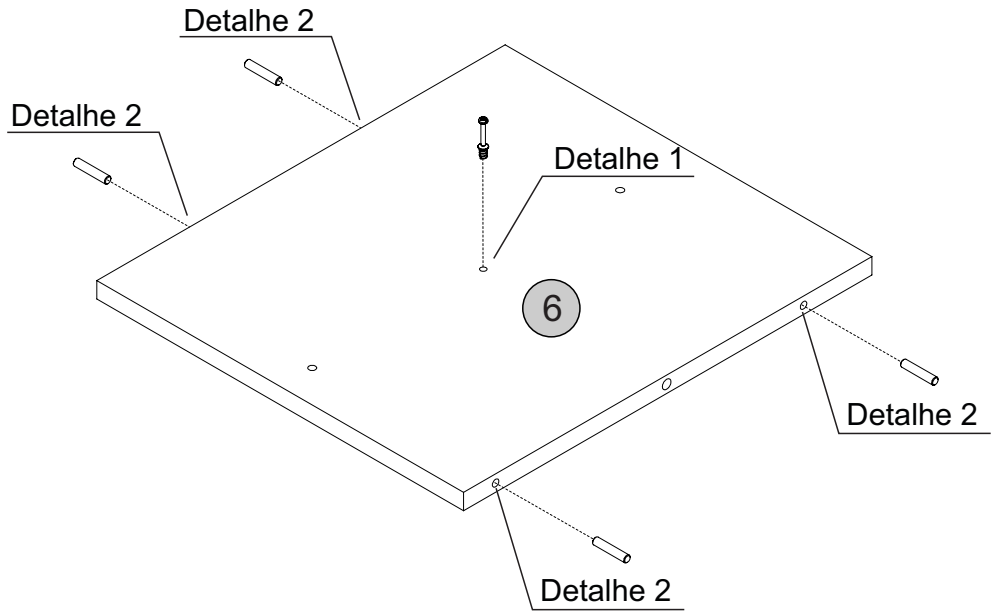
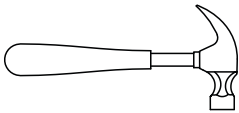
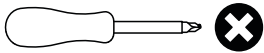

Detalhe 1
Detalle/Detail

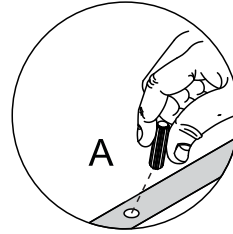
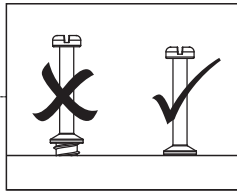

Detalhe 2
Detail/Detalle

Passo 6

Paso/Step

PEÇA
Pieza/Piece

7 - DIVISÃO ESQUERDA x1

FERRAGEM
Herraje/Hardware

A  04

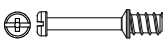
B  01

FERRAMENTA
Herramienta/Tool

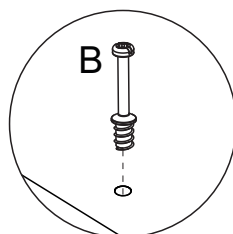
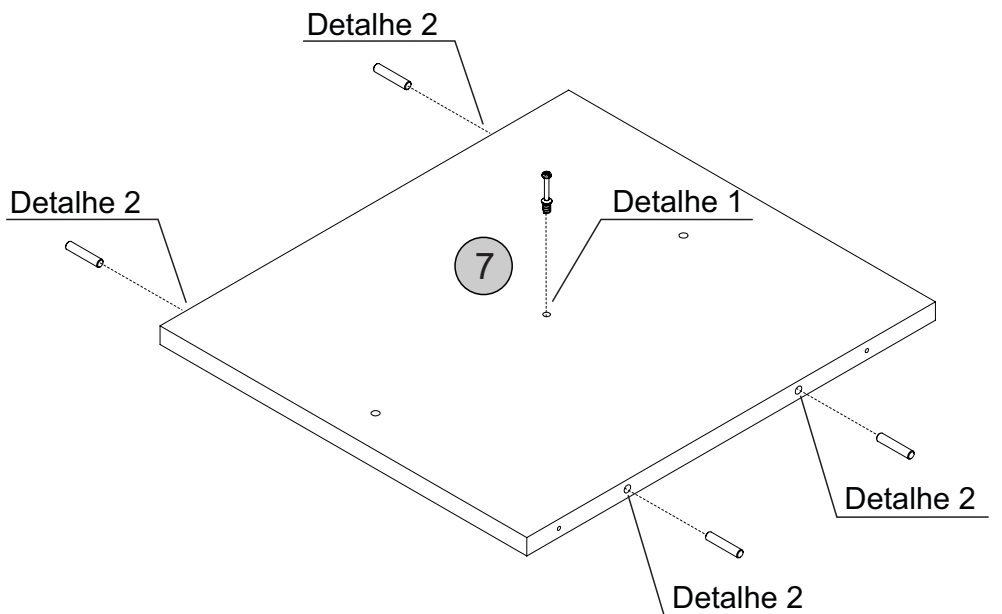
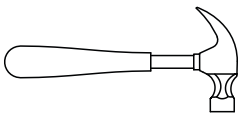
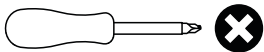

Detalhe 1
Detalle/Detail

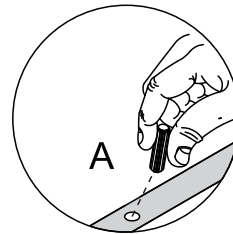
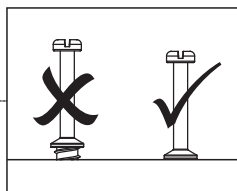

Detalhe 2
Detail/Detalle

Passo 7

Paso/Step

PEÇA

Pieza/Piece

6 - PRATELEIRA x1

FERRAGEM

Herraje/Hardware

A  04

FERRAMENTA

Herramienta/Tool

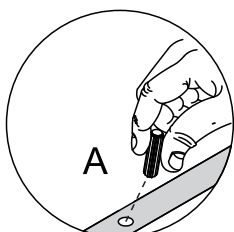
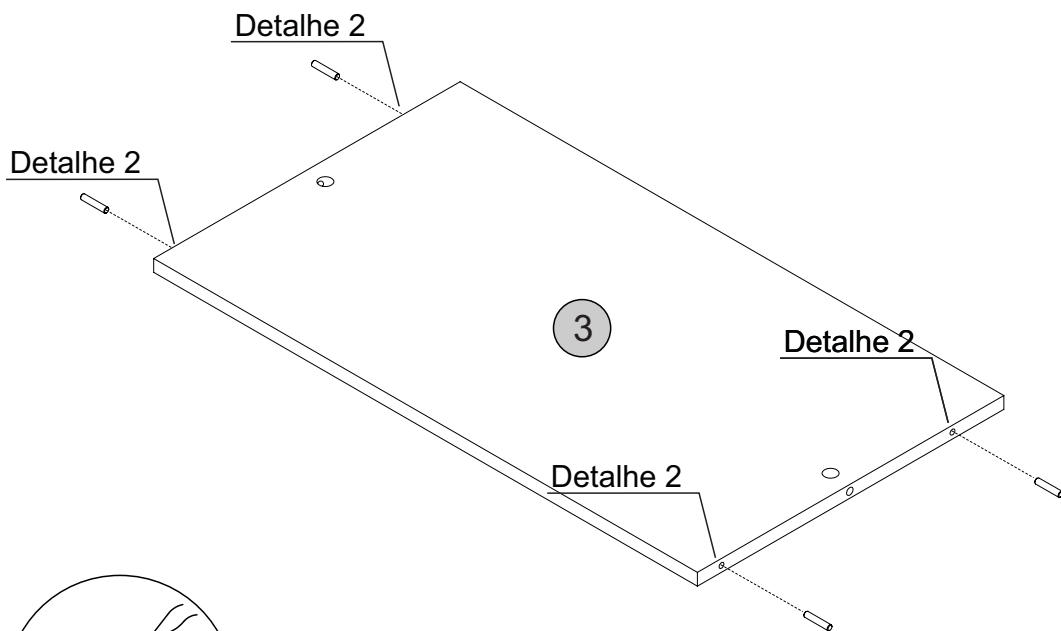
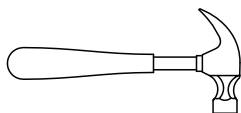

Detalhe 2
Detail/Detaille

Passo 8

Paso/Step

PEÇA

Pieza/Piece

10 - PÉ ESQUERDO x2

11 - PÉ DIREITO x2

FERRAGEM

Herraje/Hardware

B  04

N  04

FERRAMENTA

Herramienta/Tool

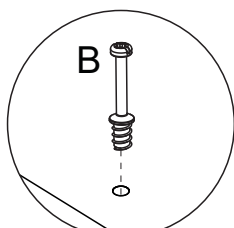
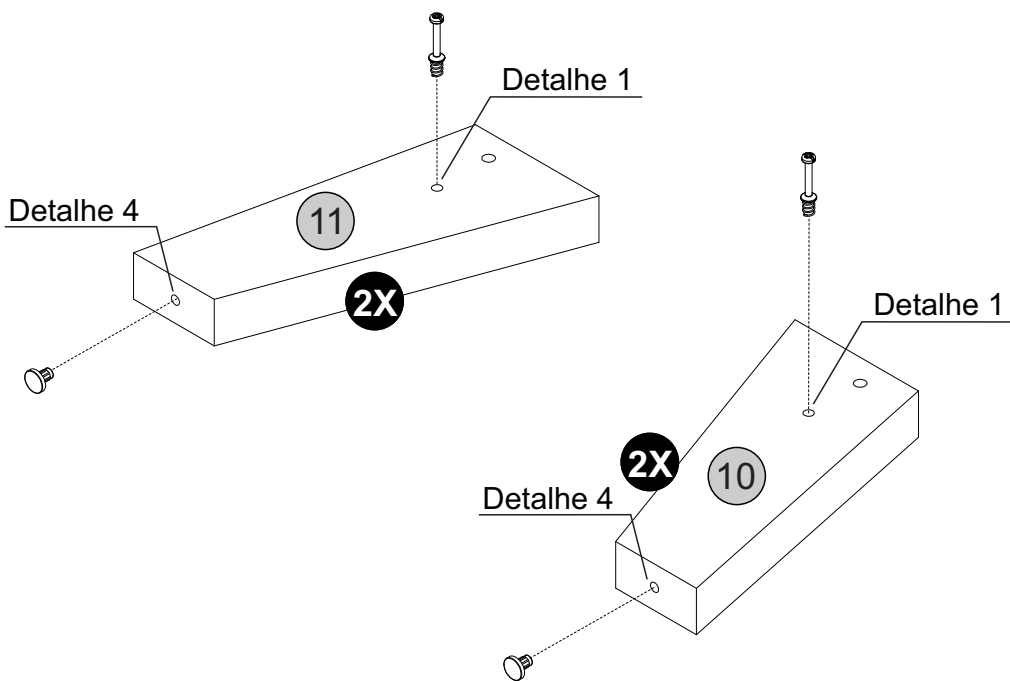
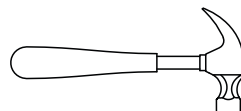
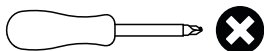

Detalhe 1
Detalle/Detail

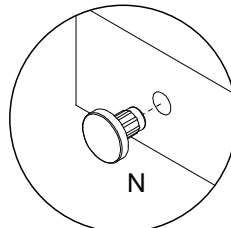
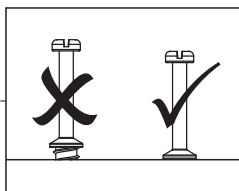

Detalhe 4
Detalle/Detail

Passo 9

Paso/Step

PEÇA
Pieza/Piece

9 - TRAVESSA DOS PÉS x2

FERRAGEM
Herraje/Hardware

A  04

FERRAMENTA
Herramienta/Tool

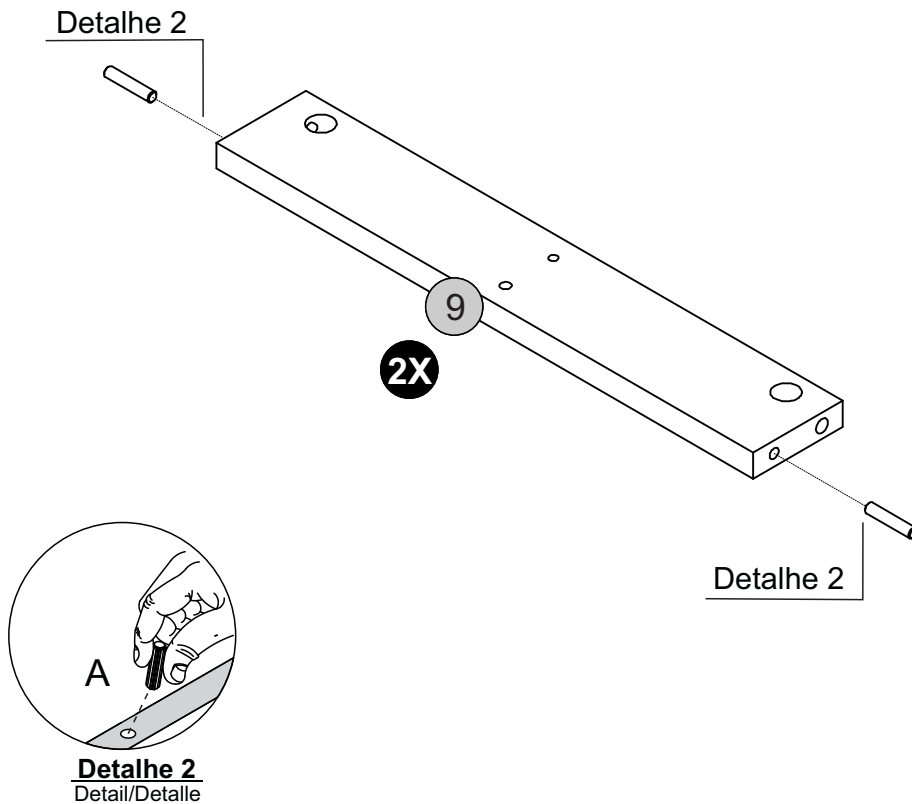
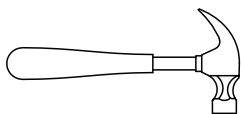

Passo 10

Paso/Step

PEÇA
Pieza/Piece

8 - TRAVESSA INFERIOR x1

FERRAGEM
Herraje/Hardware

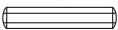
A  02

FERRAMENTA
Herramienta/Tool

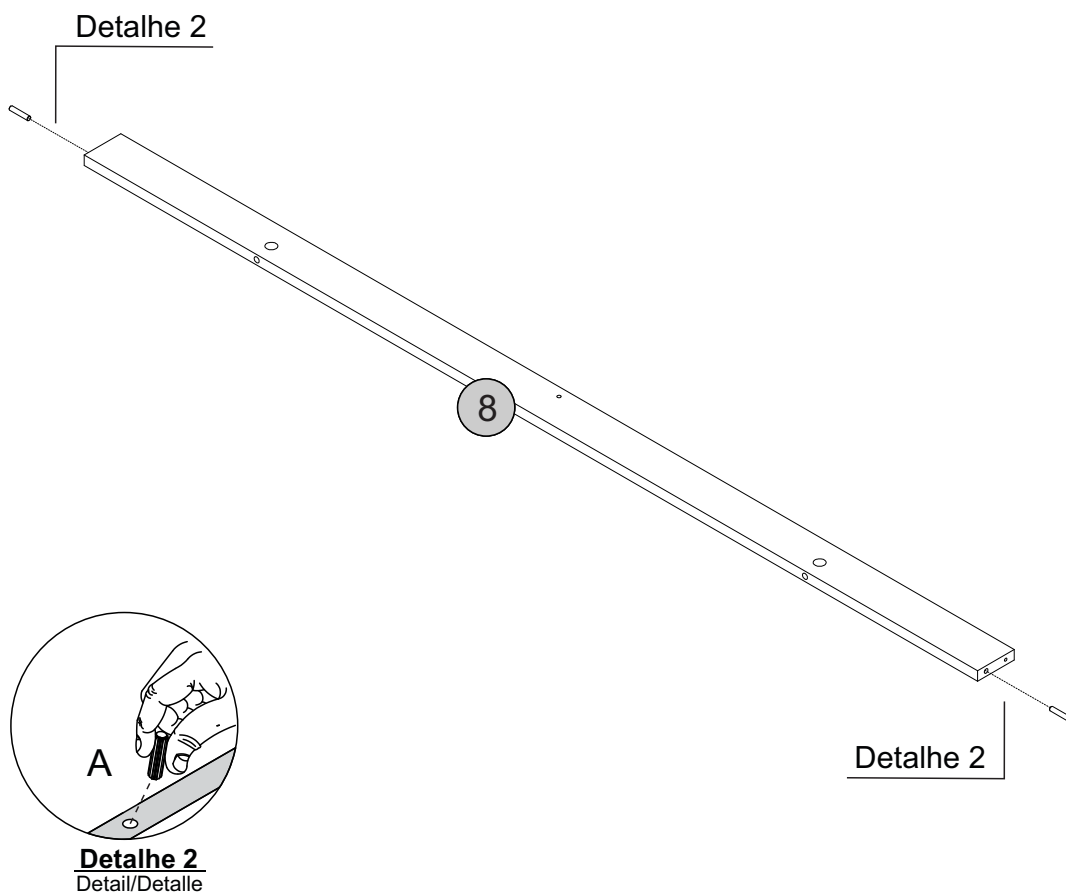
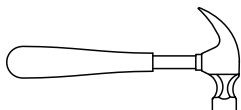

Passo 11

Paso/Step

PEÇA
Pieza/Piece

13 - PORTA x2

14 - ALMOFADA x2

FERRAGEM
Herraje/Hardware

E  20

P  20

FERRAMENTA
Herramienta/Tool

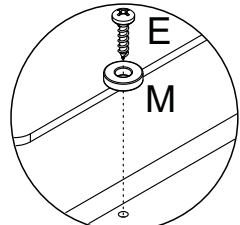
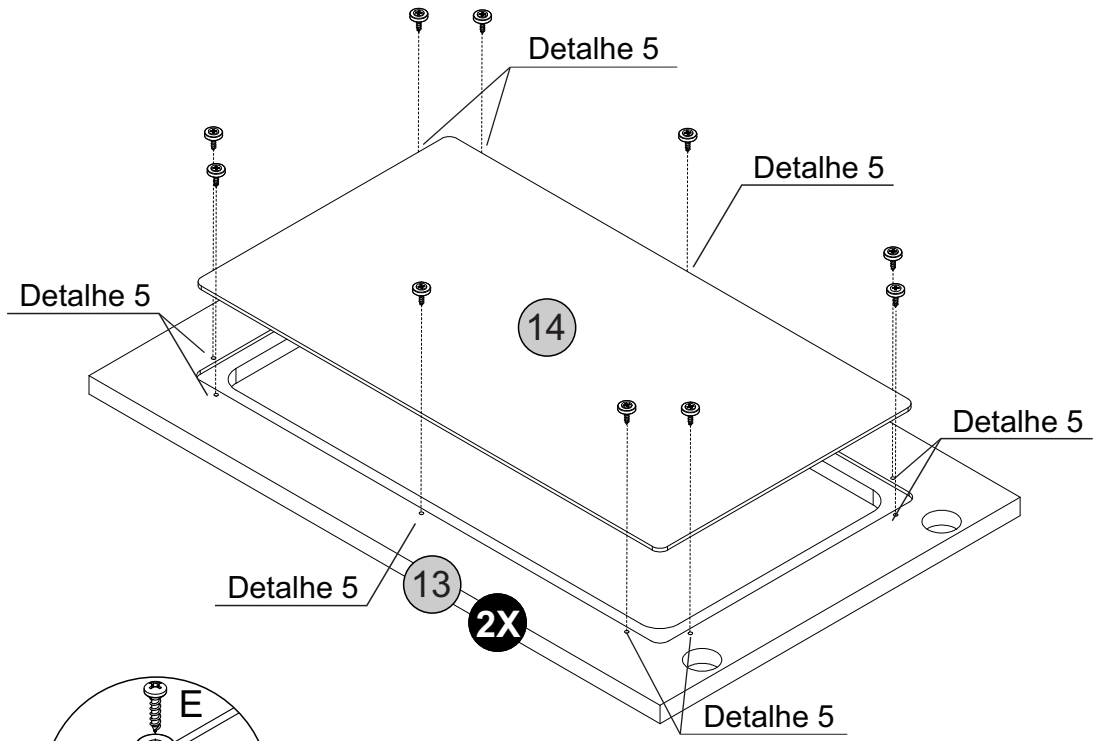
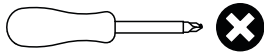

Detalhe 5
Detail/Detalle

Passo 12

Paso/Step

PEÇA
Pieza/Piece

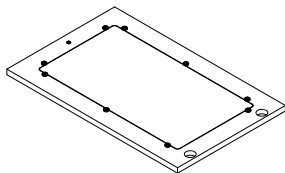

FERRAGEM
Herraje/Hardware

E  08

K  04

FERRAMENTA
Herramienta/Tool

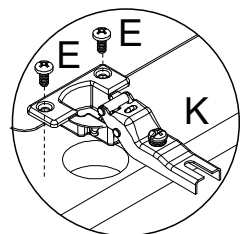
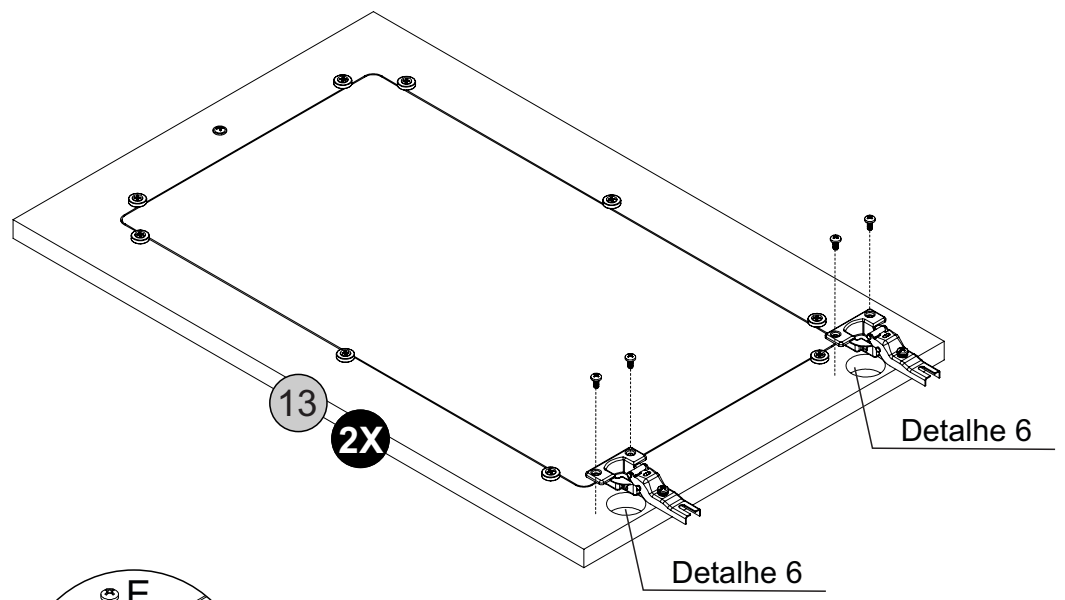
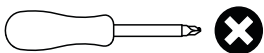

Detalhe 6
Detail/Detalle

Passo 13

Paso/Step

PEÇA

Pieza/Piece

3 - PRATELEIRA FIXA x1

7 - DIVISÃO ESQUERDA x1

FERRAGEM

Herraje/Hardware

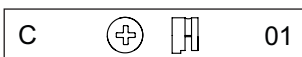

FERRAMENTA

Herramienta/Tool

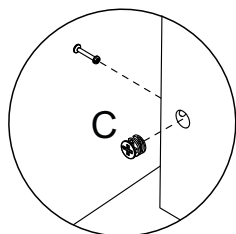
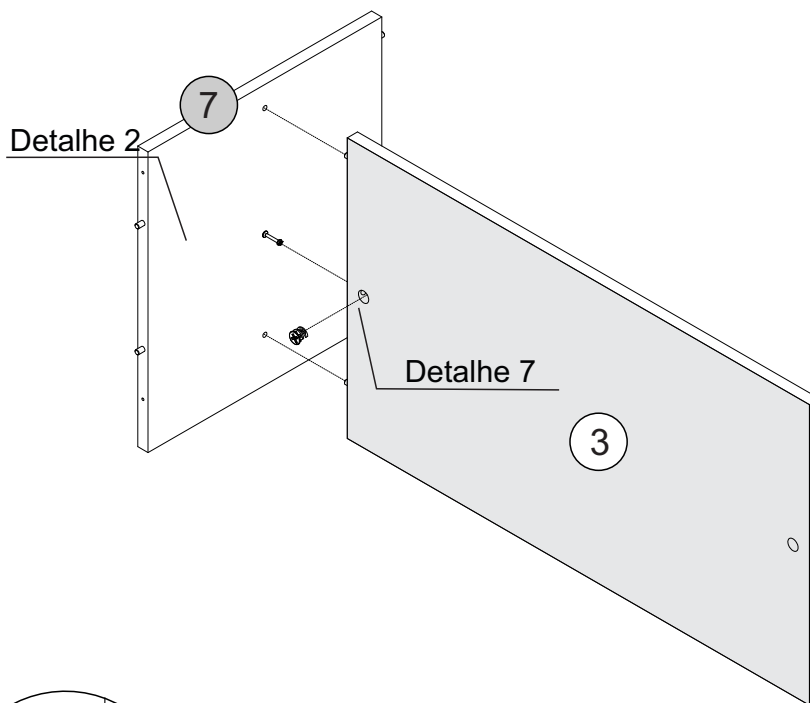
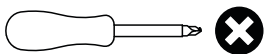

Detalhe 7
Detalle/Detail

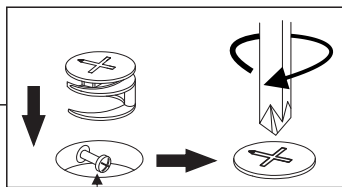

Cabeça do parafuso precisa estar no centro
La cabeza del tornillo debe estar en el centro
Screw head has to be in the center

Passo 14

Paso/Step

PEÇA

Pieza/Piece

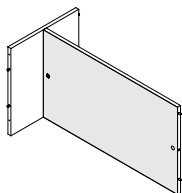

6 - DIVISÃO DIREITA x1

FERRAGEM

Herraje/Hardware

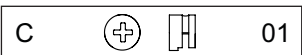

FERRAMENTA

Herramienta/Tool

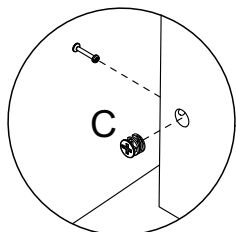
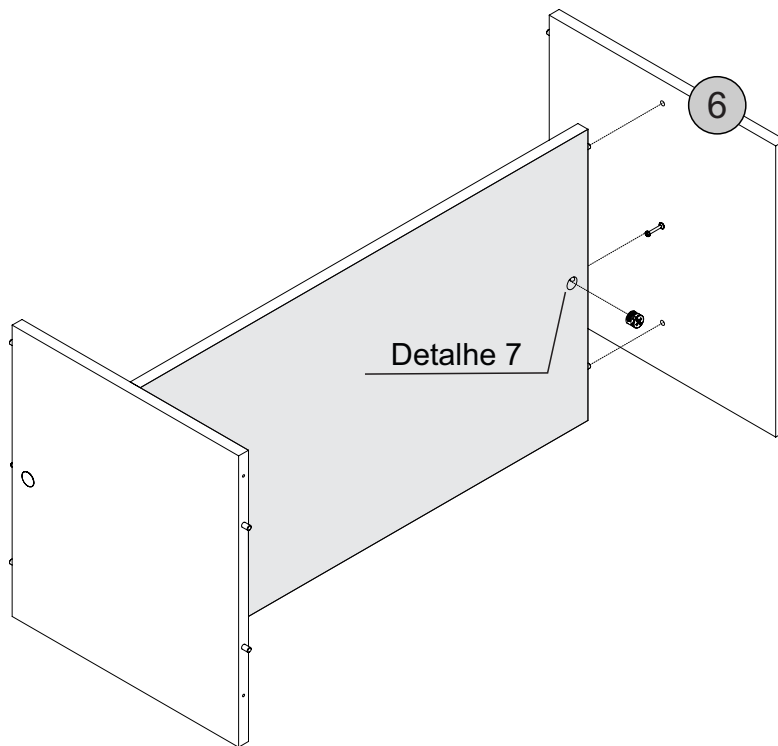
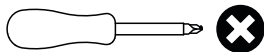

Detalhe 7
Detalle/Detail

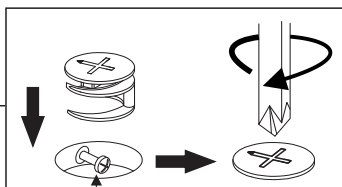

Cabeça do parafuso precisa estar no centro
La cabeza del tornillo debe estar en el centro
Screw head has to be in the center

Passo 15

Paso/Step

PEÇA

Pieza/Piece

8 - TRAVESSA INFERIOR x1

9 - TRAVESSA DOS PÉS x2

FERRAGEM

Herraje/Hardware

D  x2

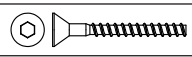
I  x2

FERRAMENTA

Tool/Herramienta

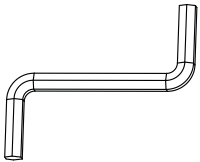

Detalhe 8

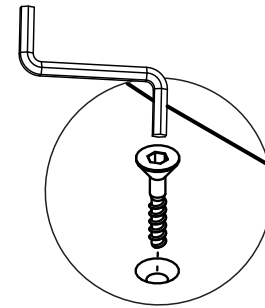
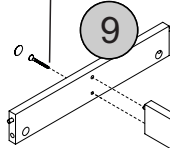

Detalhe 10
Detail/Detalle

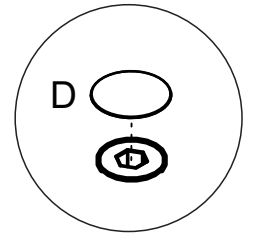

Detalhe 9
Detail/Detalle

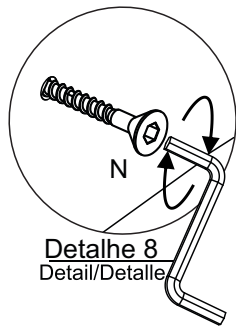

Detalhe 8
Detail/Detalle

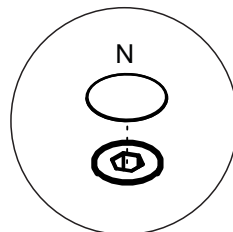

Detalhe 9
Detail/Detalle

Detalhe 8

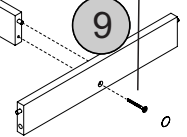

Passo 16

Paso/Step

PEÇA

Pieza/Piece

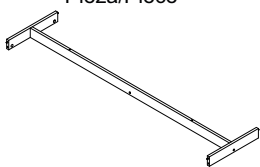



10 - PÉ ESQUERDO x2

11 - PÉ DIREITO x2

12 - PÉ CENTRAL x1

FERRAGEM

Herraje/Hardware

C   x4

D  x5

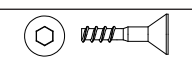
J  x1

FERRAMENTA

Herramienta/Tool

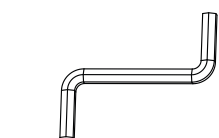
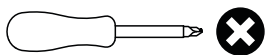

Detalhe 7

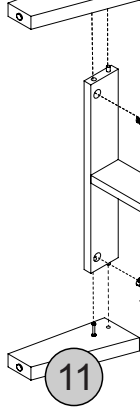

Detalhe 7

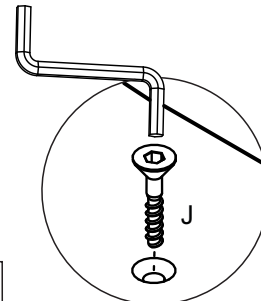

Detalhe 10
Detail/Detalle

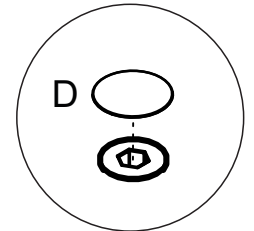

Detalhe 9
Detail/Detalle

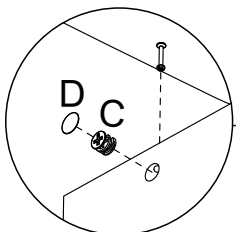

Detalhe 7
Detalle/Detail

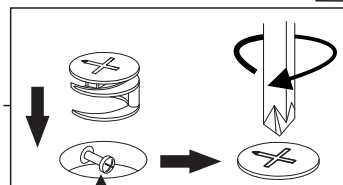

Cabeça do parafuso precisa estar no centro
La cabeza del tornillo debe estar en el centro
Screw head has to be in the center

Detalhe 7

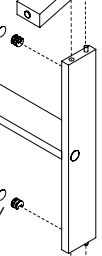

Passo 17

Paso/Step

PEÇA
Pieza/Piece

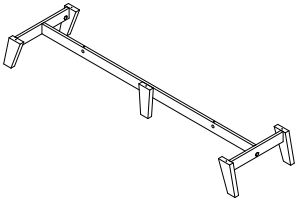

2 - BASE x1

FERRAGEM
Herraje/Hardware

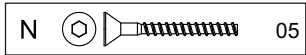

FERRAMENTA
Tool/Herramienta

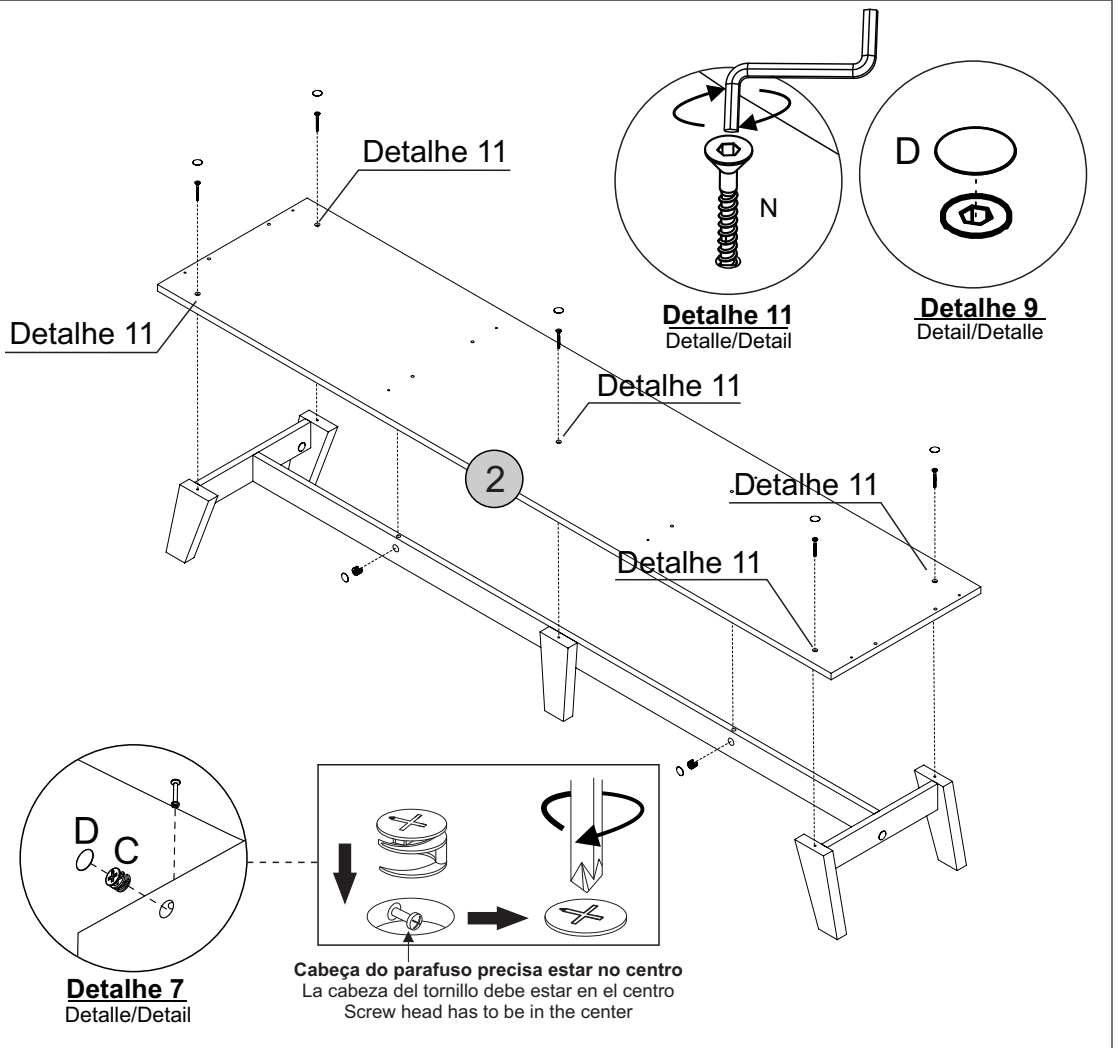
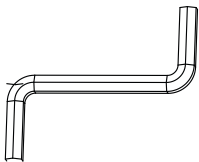

Passo 18

Paso/Step

PEÇA
Pieza/Piece

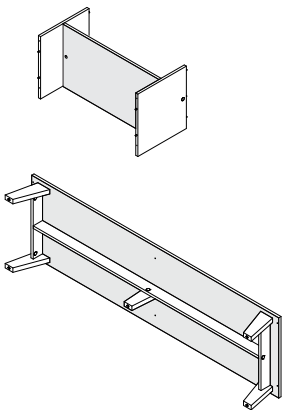

FERRAMENTA
Herramienta/Tool

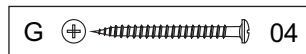

FERRAMENTA
Herramienta/Tool

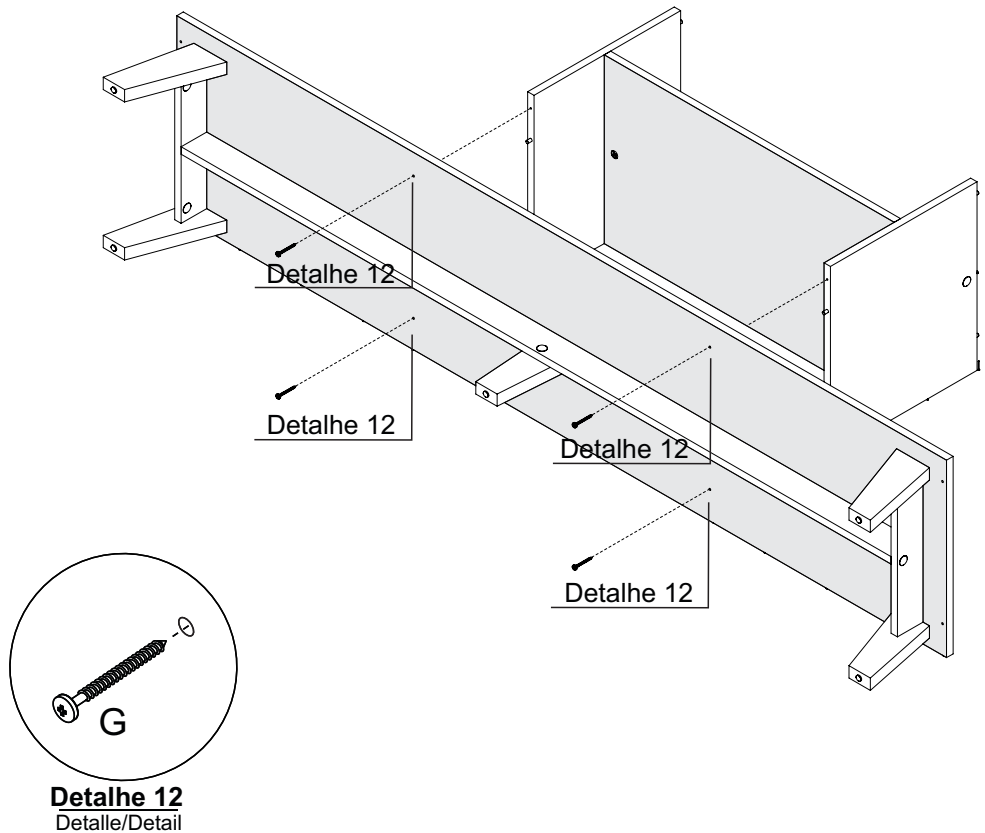
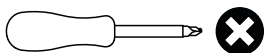

Passo 19

Paso/Step

PEÇA
Pieza/Piece

5 - LATERAL ESQUERDA x1

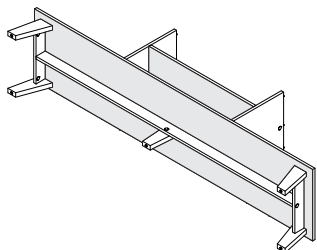

FERRAMENTA
Herramienta/Tool

G  02

FERRAMENTA
Herramienta/Tool

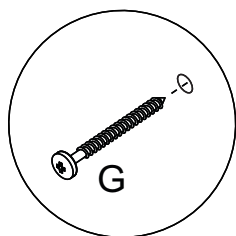
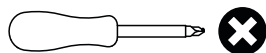

Detalhe 12
Detalle/Detail

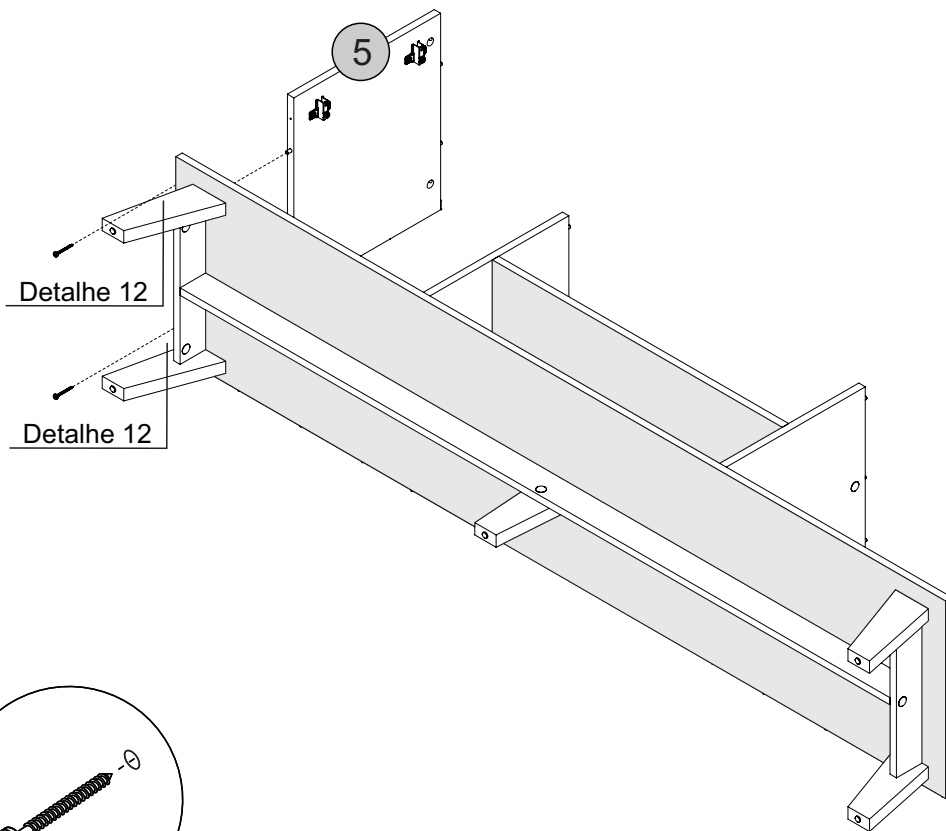

Passo 20

Paso/Step

PEÇA
Pieza/Piece

4 - LATERAL DIREITA x1

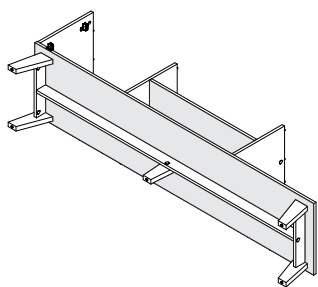

FERRAMENTA
Herramienta/Tool

G  02

FERRAMENTA
Herramienta/Tool

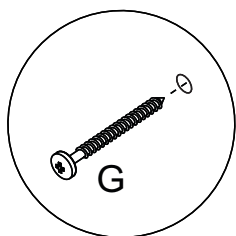
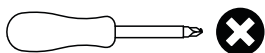

Detalhe 12
Detalle/Detail

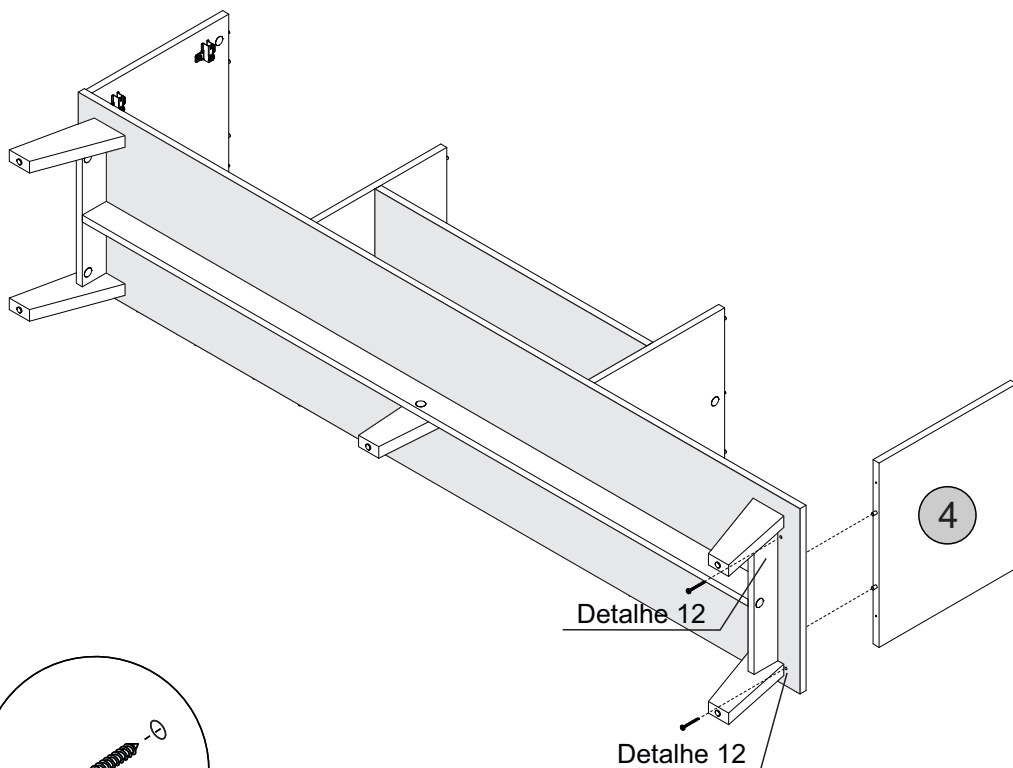

Passo 21



Paso/Step

PEÇA
Pieza/Piece

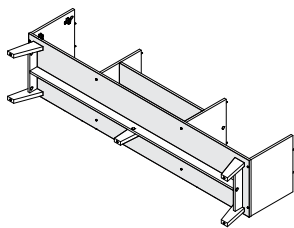
1 - TAMPO x1



FERRAGEM
Herraje/Hardware

C   06

FERRAMENTA
Herramienta/Tool

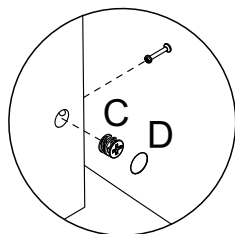
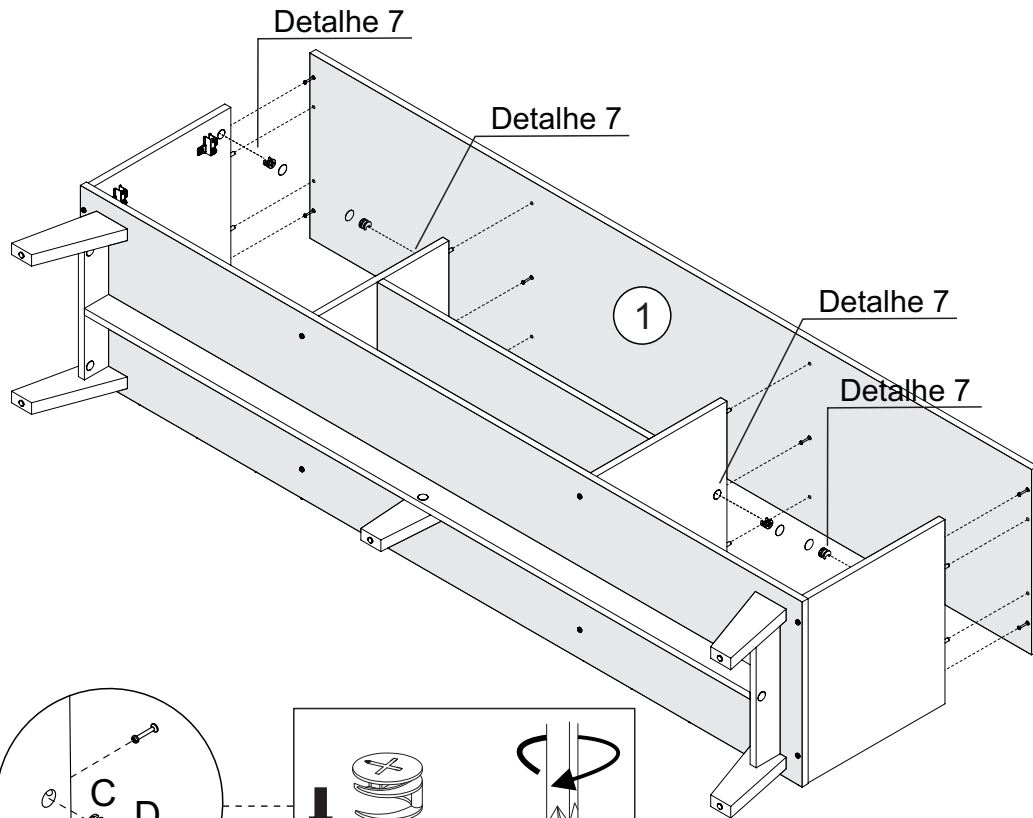
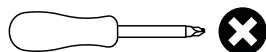

Detalhe 7
Detalle/Detail

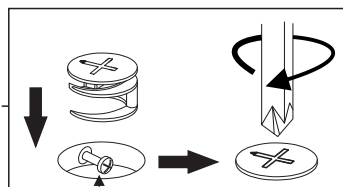

Cabeça do parafuso precisa estar no centro
La cabeza del tornillo debe estar en el centro
Screw head has to be in the center

Passo 22

Paso/Step

PEÇA
Pieza/Piece

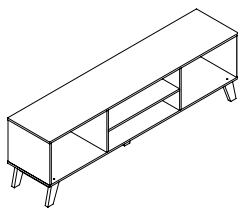

15 - TRASEIRO x1

FERRAGEM
Hardware/Herraje

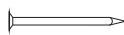
H  28

FERRAMENTA
Tool/Herramienta

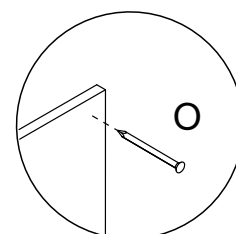
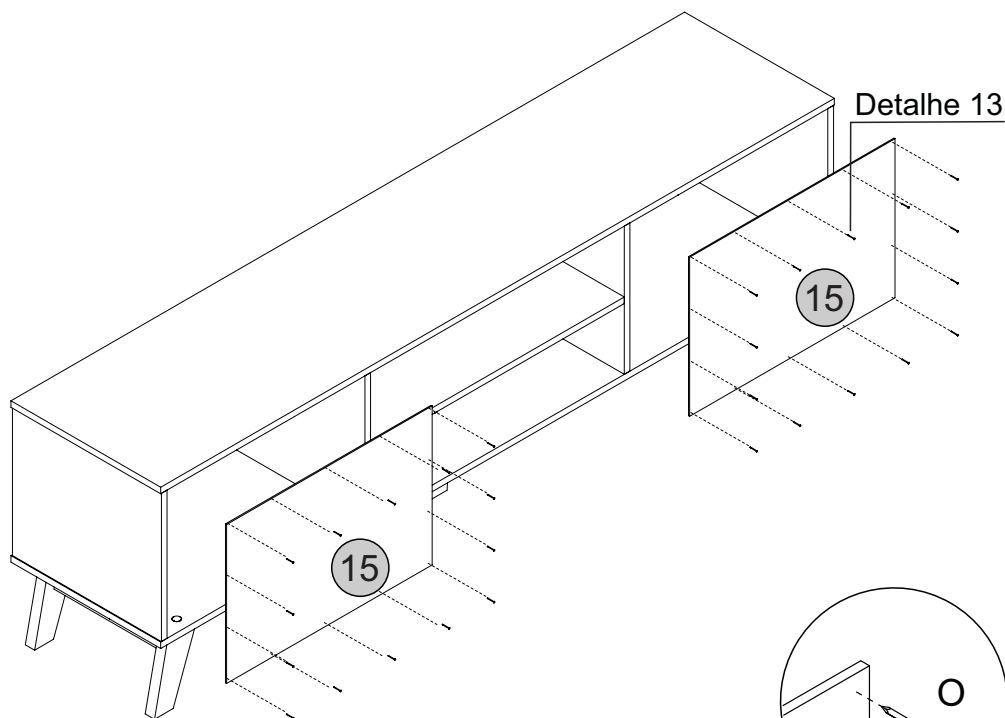
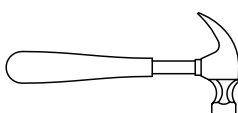

Detalhe 13
Detail/Detalle

Passo 23

Paso/Step

PEÇA
Pieza/Piece

13 - PORTA x2

FERRAGEM
Herraje/Hardware

H  02

M  02

FERRAMENTA
Herramienta/Tool

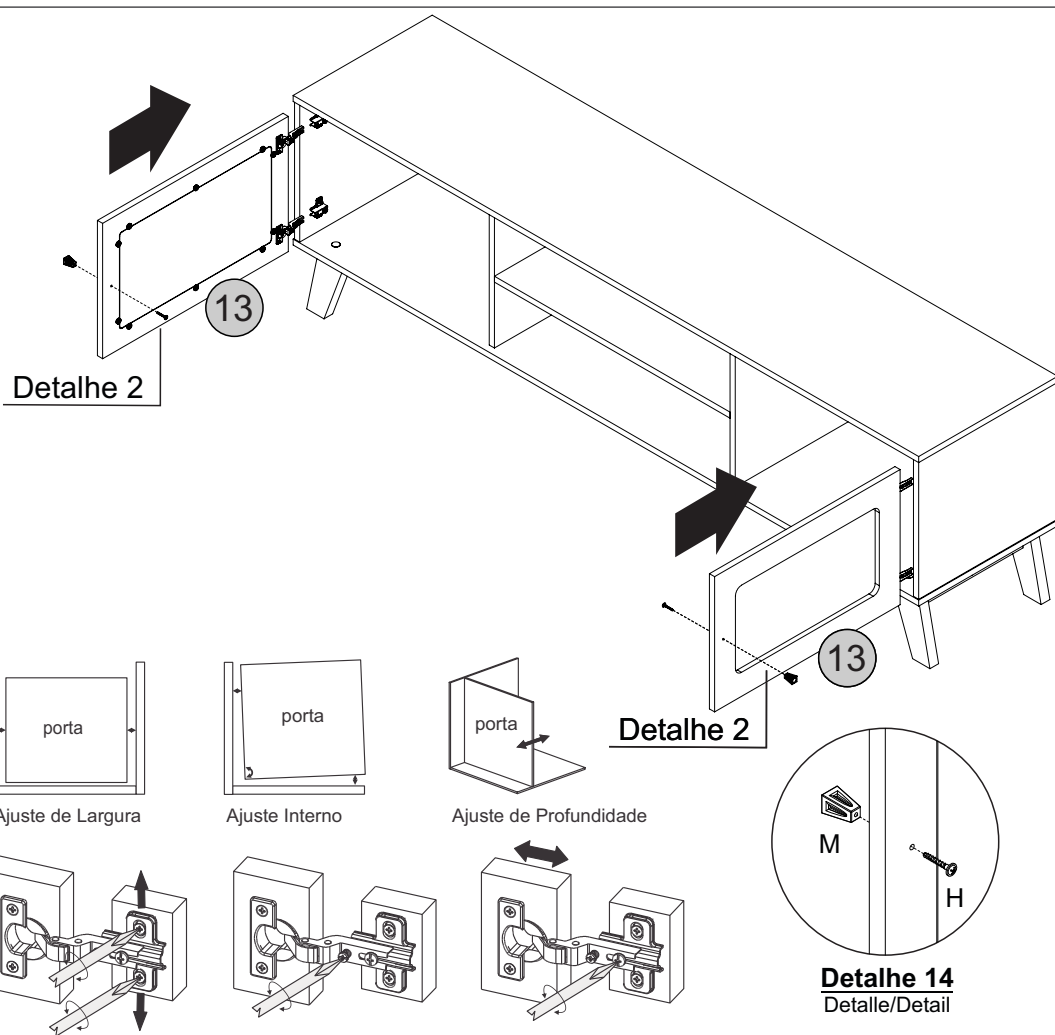
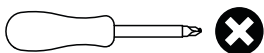

Passo 24

Paso/Step

PEÇA
Pieza/Piece

FERRAGEM
Herraje/Hardware

FERRAMENTA
Herramienta/Tool

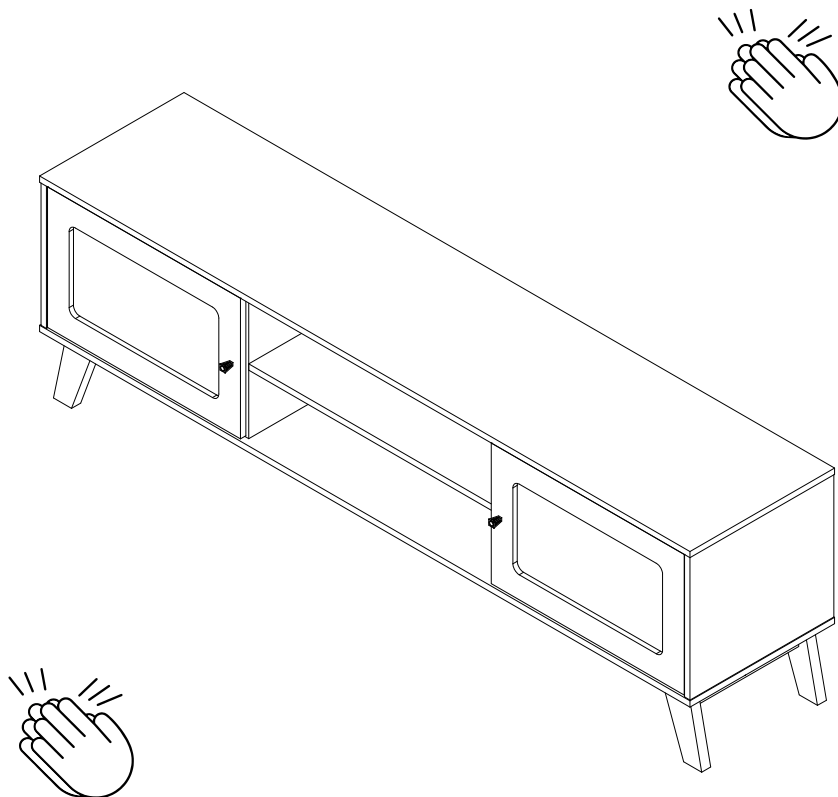

Parabéns, você montou seu móvel! Agora é só decorar sua casa e aproveitar!

Queremos ver como ficou o móvel Artely do seu jeito... Marque a gente com a #meuartely. Ficaremos felizes em compartilhar!

Ah, e se tiver qualquer dúvida, sugestão ou comentário, entra em contato com a gente pelo nosso site www.artely.com.br.

¡Congratulaciones, montaste tu mueble! ¡Ahora solo decora tu casa y disfruta!

Queremos ver este producto en tu hogar, a tu manera... Utilice #meuartely, ¡ficaremos encantados de compartir tu foto!

Si tienes alguna duda, sugerencia o comentario, contáctenos a través de nuestro sitio web www.artely.com.br.

Congratulations, you've assembled your new furniture! Decorate your home and enjoy!

We want to see how this product is in your home... Use #meuartely, we will be happy to share your picture!

If you have any doubt, suggestion or comment, get in touch with us through our website www.artely.com.br.