

HENN

Ind. e Com. de Móveis Henn
Mondai - SC - Brasil

+55 49 3674.3500

@moveishenn
www.henn.com.br

INSTRUÇÕES DE MONTAGEM

INSTRUCCIONES DE MONTAJE
ASSEMBLY INSTRUCTIONS

ITM/S35-

CADEIRA MILLA

S35-502 Nature Linho

S35-510 Nature Marrom Amêndoa

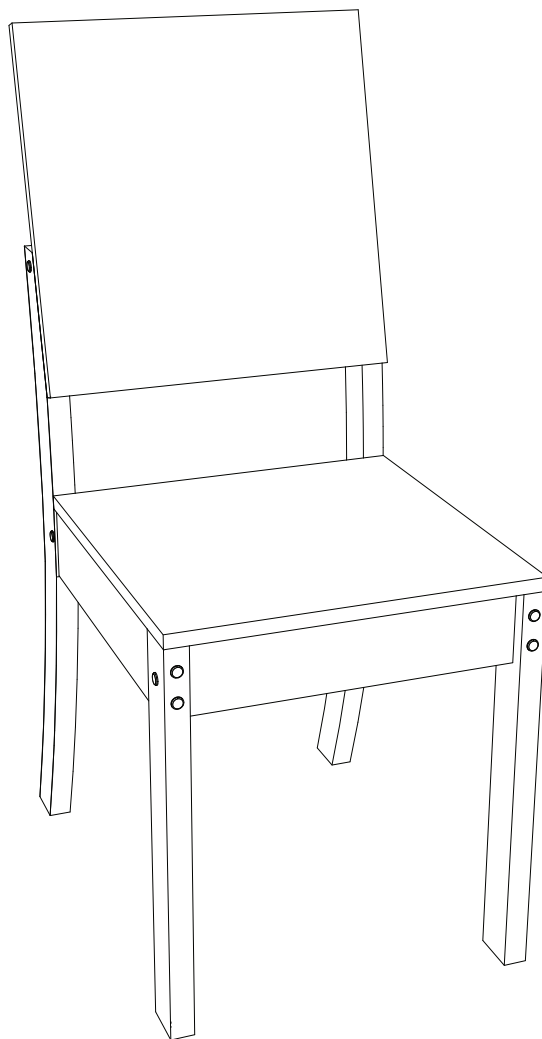

Requisitos para montagem Requisitor para la montaje Assembly Requirements

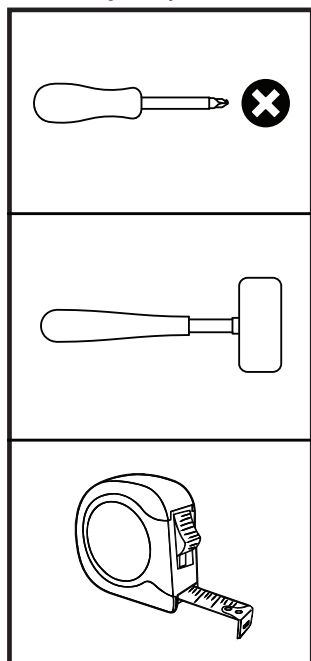

Imagens meramente ilustrativas,
não acompanha o produto.
Imágenes ilustrativas, no incluidas
con el producto.
Illustrative images, not included
with the product.

AVISO

Para limpeza de seu móvel, use uma flanela seca ou umedecida, e não utilize produtos químicos que possam danificar seu produto.

SISTEMA DE MONTAGEM

O sistema de montagem dos produtos, funciona de acordo com a ordem crescente dos números indicados no desenho. Ex: 01, 02, 03, 04... até a conclusão da montagem.

ASSISTÊNCIA TÉCNICA

Para solicitação de Assistência Técnica você consumidor deverá entrar em contato com o Lojista o qual você realizou a compra deste produto e solicitar a assistência técnica das peças avariadas. A garantia abrange todas as peças, partes e componentes que eventualmente venham apresentar defeito de fabricação no prazo de 03 (três) meses, contando a partir da entrega do produto ao consumidor, mediante nota fiscal de compra. Se houver qualquer alteração na estrutura do produto ou ocorrer defeito por negligência do montador/consumidor em relação a instrução de montagem e manuseio, não será fornecido assistência técnica gratuita.

ADVERTENCIA

Para limpieza de su móvil, use una flanela seca o húmeda, y no utilice productos químicos que puedan dañar su producto.

SISTEMA DE MONTAJE

El sistema de montaje de los productos funciona de acuerdo con el orden creciente de los números indicados en el dibujo. Ej.: 01, 02, 03, 04... hasta la conclusión del montaje.

ASISTENCIA TÉCNICA

Para solicitar Asistencia Técnica, el consumidor debe comunicarse con el Comercio que usted realizó la compra de este producto y solicita asistencia técnica para las partes dañadas. La garantía cubre todas las partes, piezas y componentes que eventualmente puedan presentar defecto de fabricación en el plazo de 03 (tres) meses, contados a partir de la entrega del producto al consumidor, mediante factura de compra. Si se produce algún cambio en la estructura del producto o se produce un defecto por negligencia del montador/consumidor en relación con las instrucciones de montaje y manipulación, no se prestará asistencia técnica gratuita.

NOTICE

To clean your furniture, use a dry or wet cloth, and do not use chemicals that may damage your product.

ASSEMBLY SYSTEM

The products' assembly system works according to the increasing order of the indicated numbers. For example: 01, 02, 03, 04 ... to the end of the assembly.

TECHNICAL ASSISTANCE







To request Technical Assistance, the consumer must contact the retailer from whom you purchased this product and request technical assistance for the damaged parts. The warranty covers all parts, parts and components that may eventually present a manufacturing defect within a period of 03 (three) months, counting from the delivery of the product to the consumer, by means of a purchase invoice. If there is any change in the structure of the product or defect occurs due to negligence of the assembler/consumer in relation to the assembly and handling instruction, free technical assistance will not be provided.

1 Pré Montagem Preasamblea | Pre-assembly

Peças Necessárias | Partes requeridas | Required Parts:

1	Pé Traseiro Pie trasero Hind Foot	08
2	Travessa Frontal Plato delantero Front Platter	08
3	Travessa Traseira Travesaño trasero Rear cross member	04
4	Pé Frontal Pie delantero Front foot	08
5	Travessa Lateral Plato lateral Side Platter	08

Ferragens | Herrajes | Hardware:

C		x24
D		x08
E		x48
F		x16
G		x16
H		x08
K		x02

Ferramentas | Instrumentos | Tools:

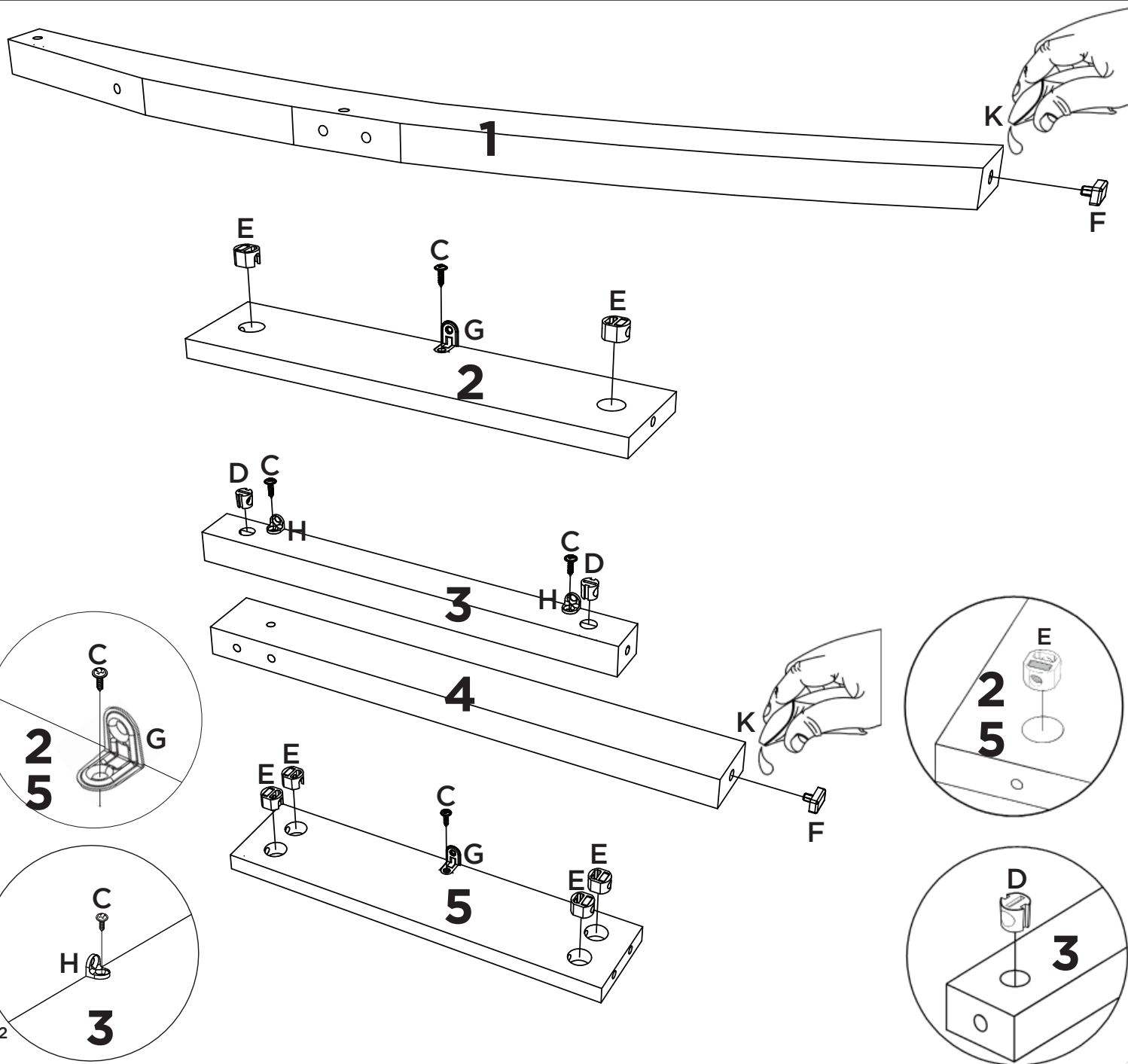
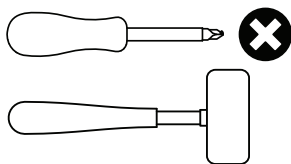



2

Peças Necessárias | Partes requeridas | Required Parts:

1	Pé Traseiro Pie trasero Hind Foot	08
2	Travessa Frontal Plato delantero Front Platter	04
3	Travessa Traseira Travesaño trasero Rear cross member	04

Ferragens | Herrajes | Hardware:

B		x16
L		

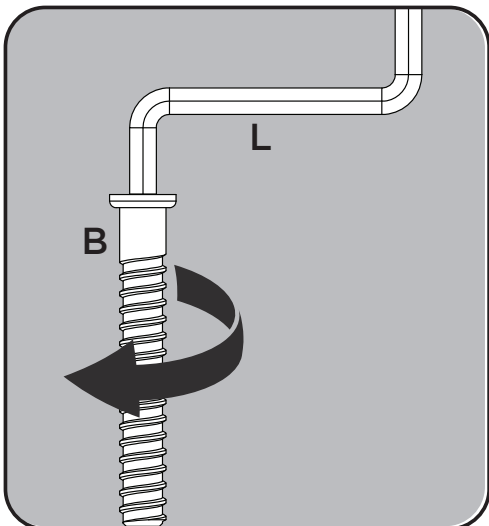
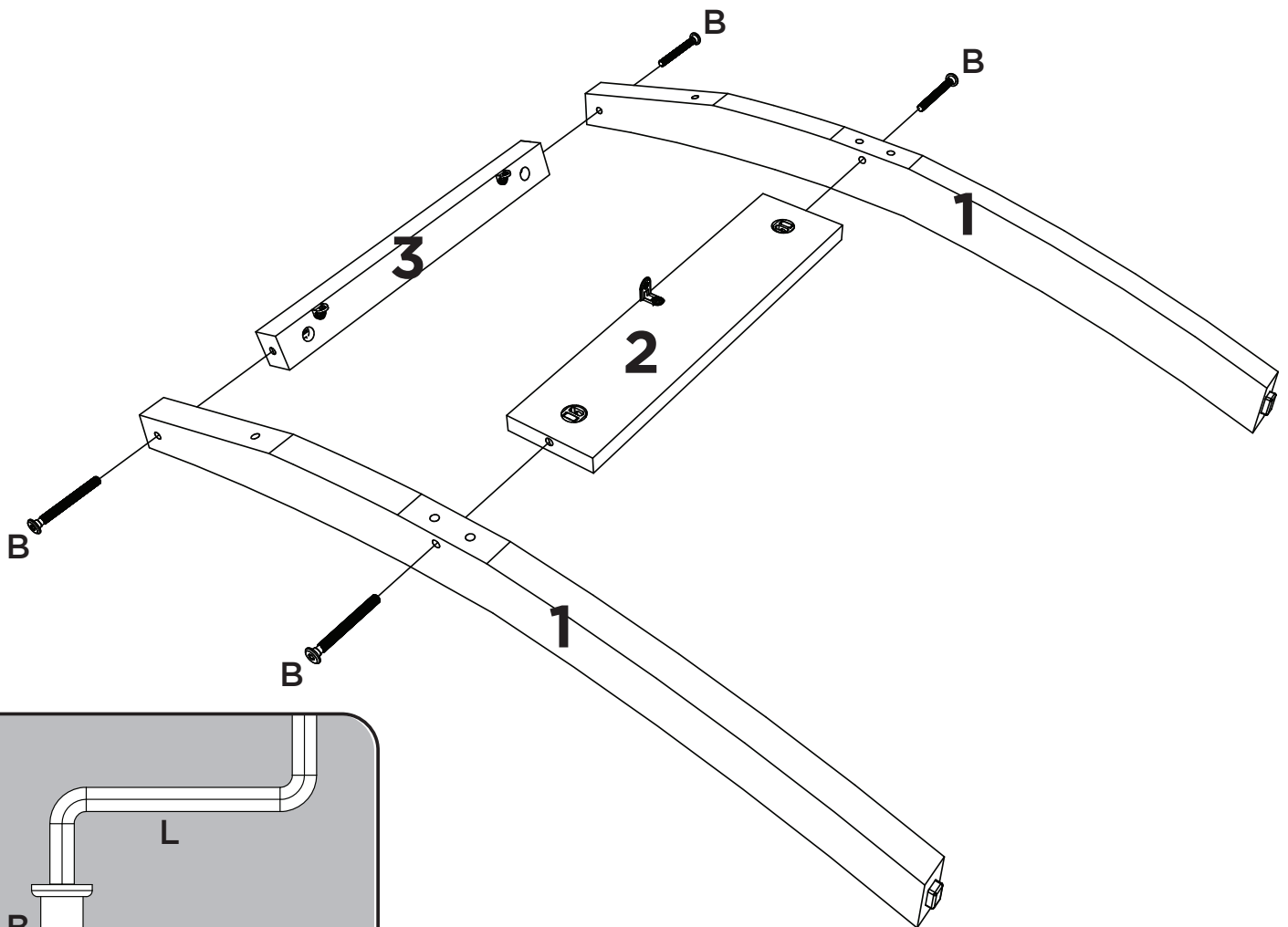



3

Peças Necessárias | Partes requeridas | Required Parts:

4	Pé Frontal Pie delantero Front foot	08
5	Travessa Lateral Plato lateral Side Platter	08

Ferragens | Herrajes | Hardware:

A		x32
L		

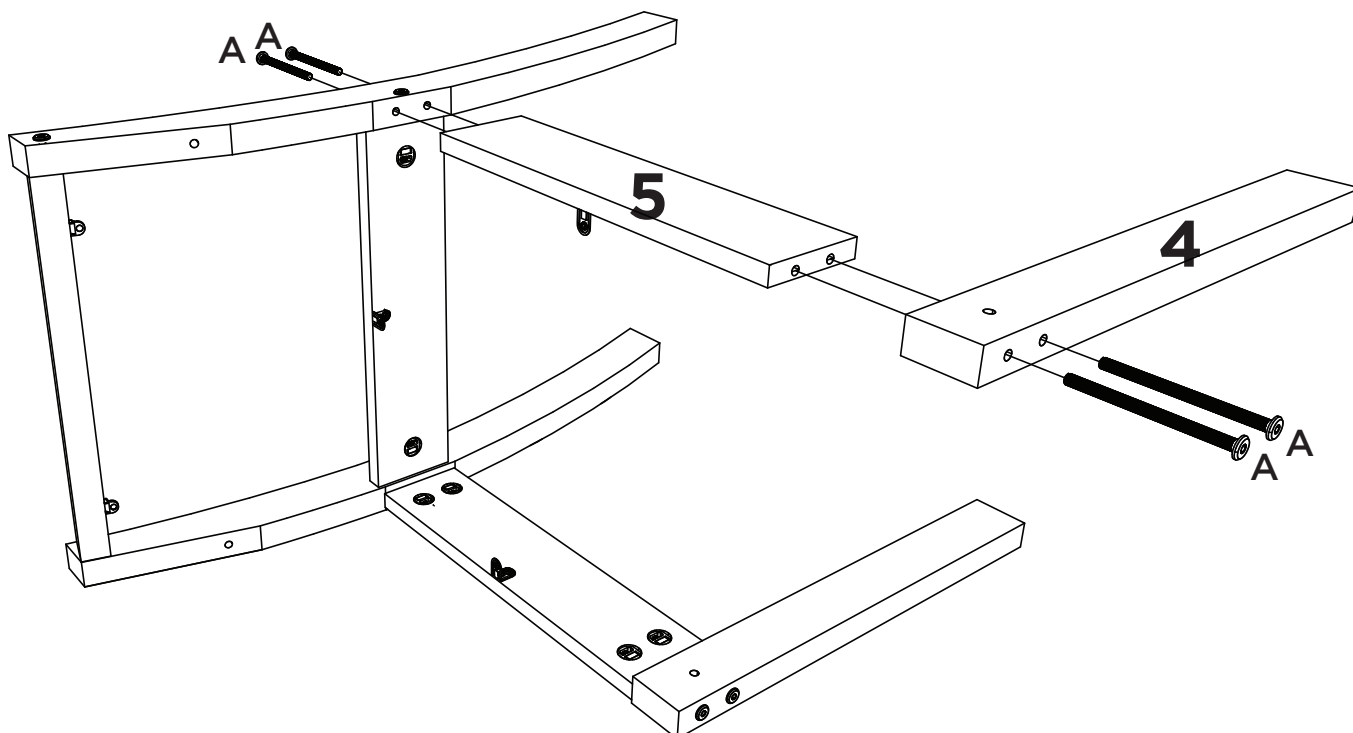
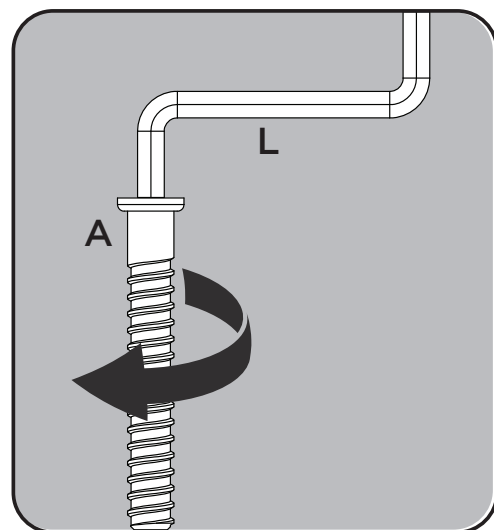
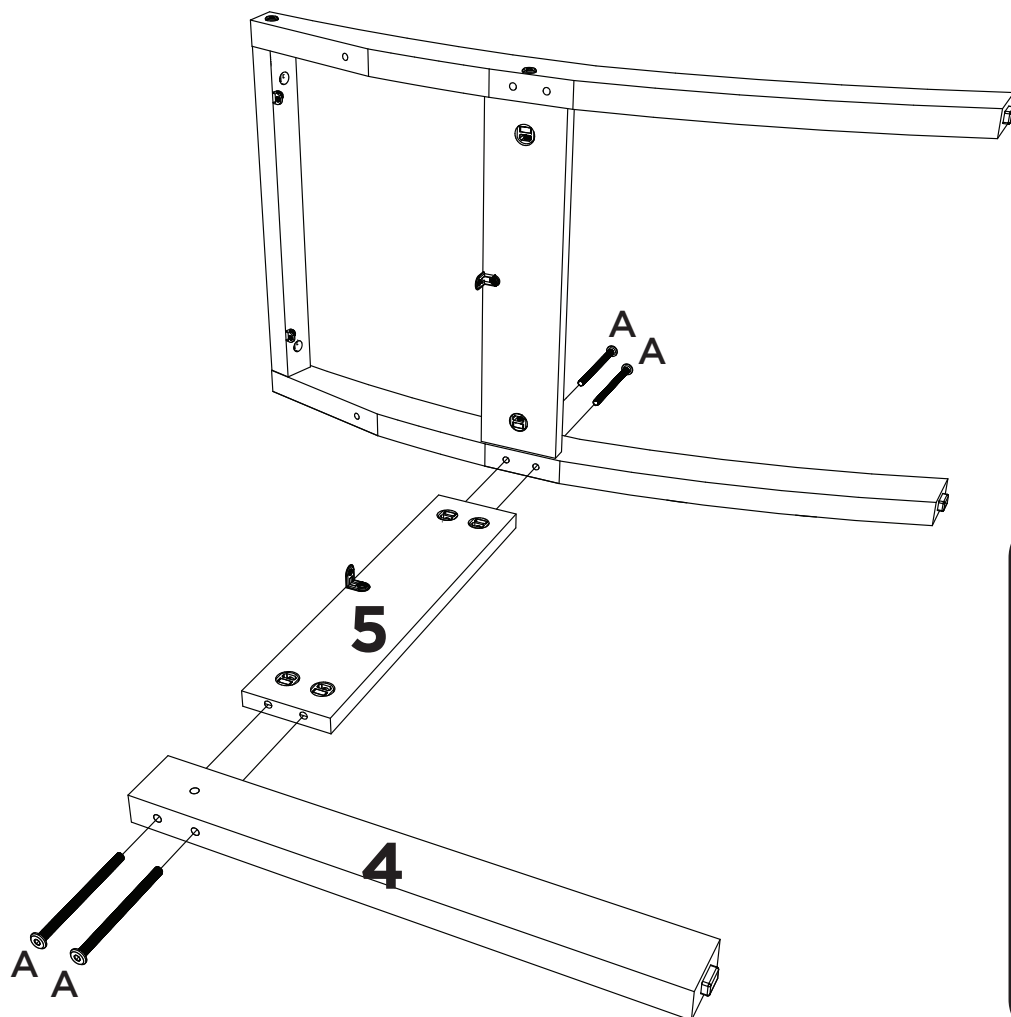



4

Peças Necessárias | Partes requeridas | Required Parts:

2	Travessa Frontal Plato delantero Front Platter	04
---	--	----

Ferragens | Herrajes | Hardware:

B			x08
L			

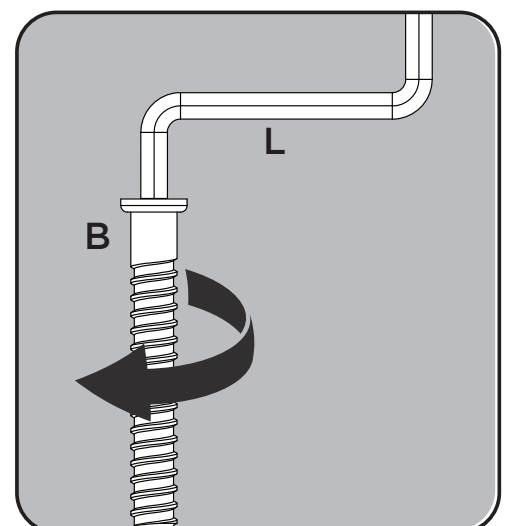
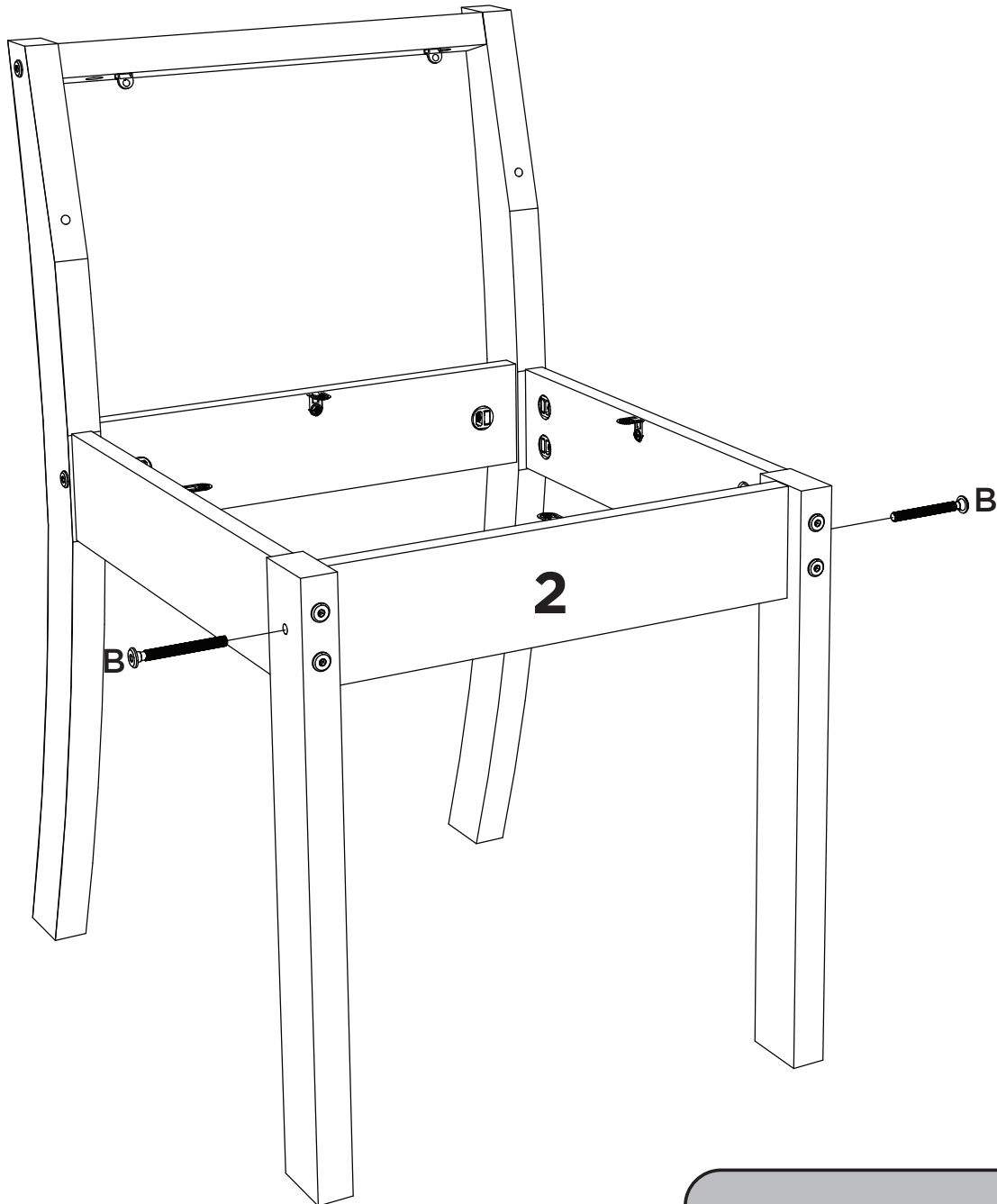



5

Peças Necessárias | Partes requeridas | Required Parts:

6	Encosto Estofado Respaldo tapizado Upholstered backrest	04
7	Assento Estofado Asiento tapizado Upholstered seat	04

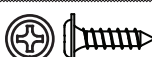
Ferragens | Herrajes | Hardware:

B		x08
C		x24
L		

Ferramentas | Instrumentos | Tools:

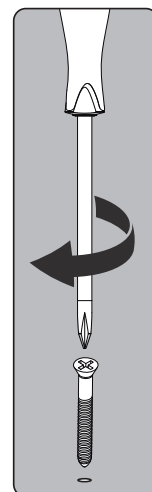
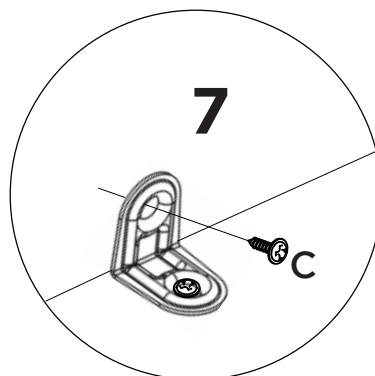
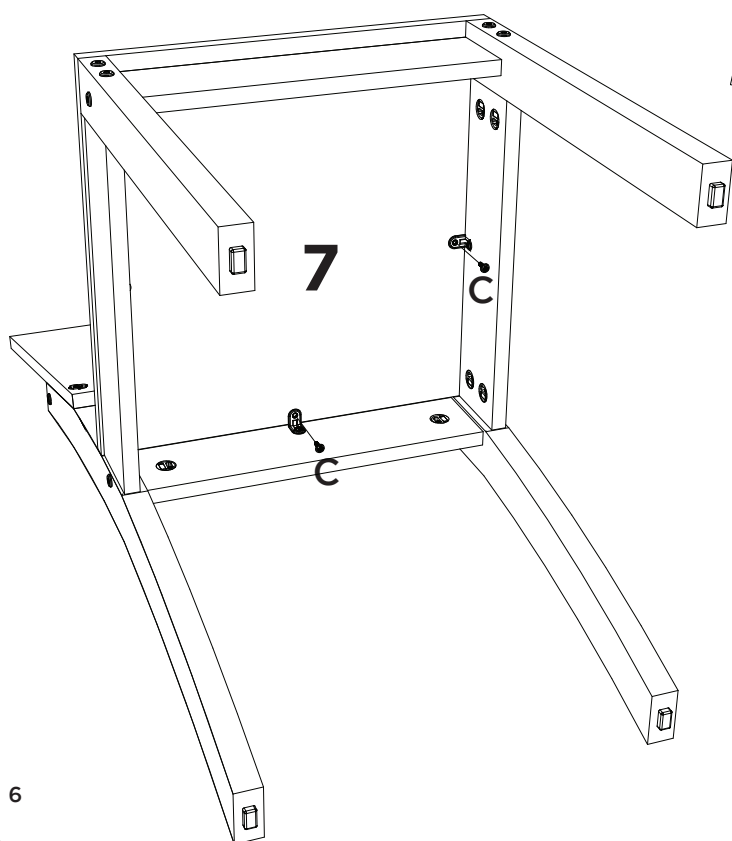
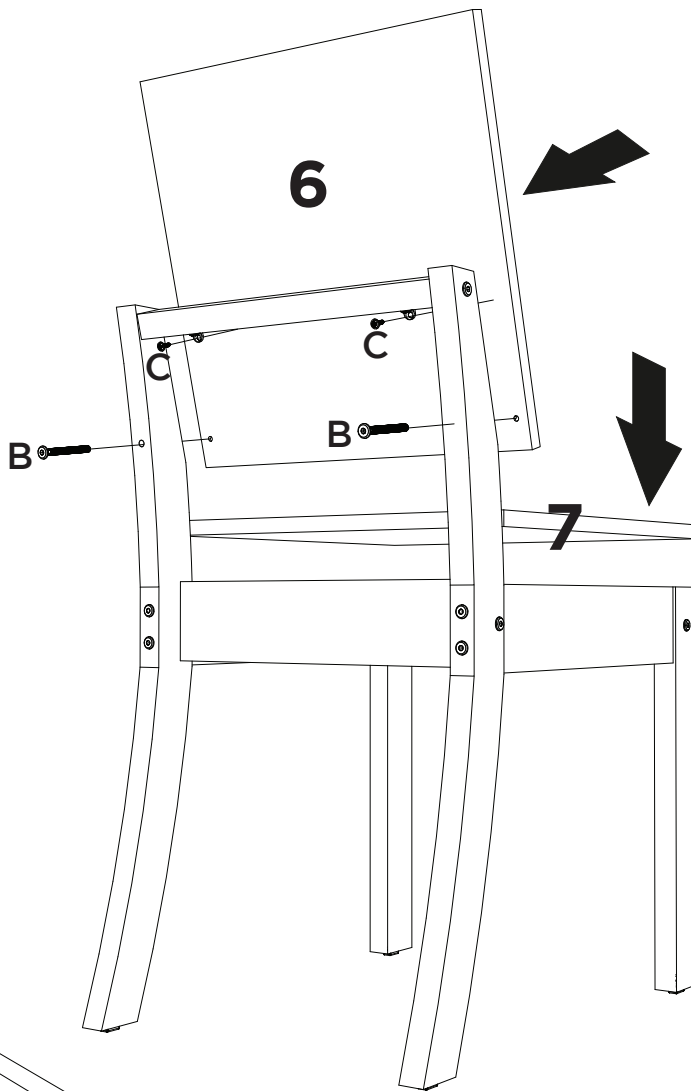
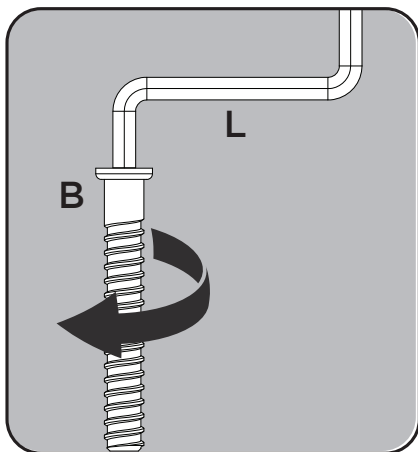
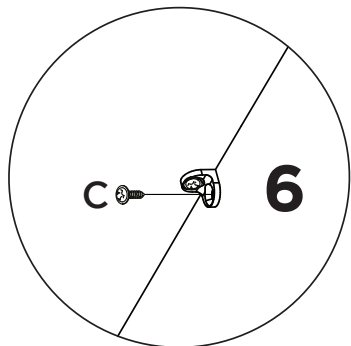
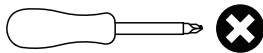

6

Ferragens | Herrajes | Hardware:

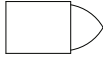
I		x64
J		x01

Pesos máximos recomendados com carga distribuída
 Peso máximo recomendado con la carga distribuída
 Recommended maximum weights with evenly distributed.

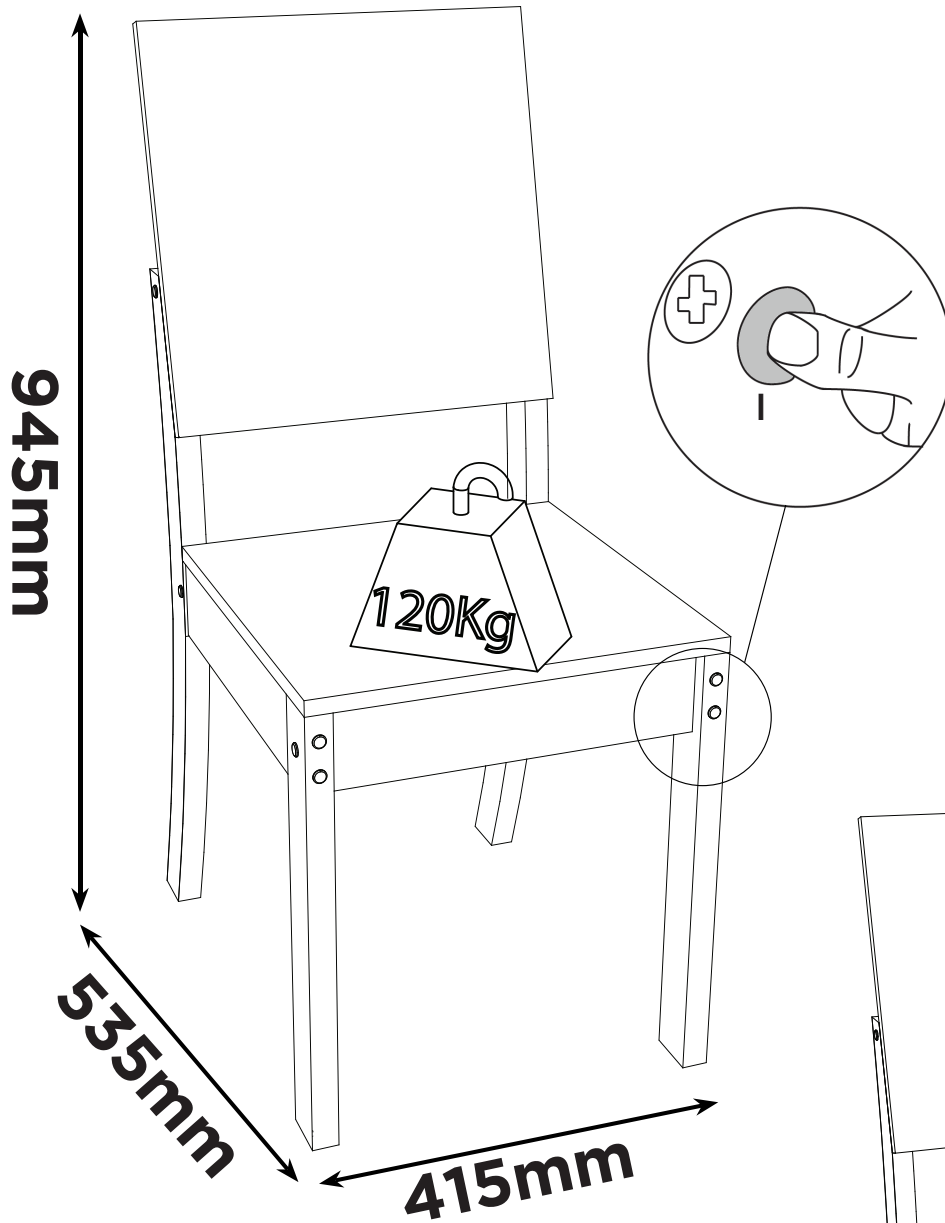

PERFECT CORRECTION
 CORRECCIÓN PERFECTA

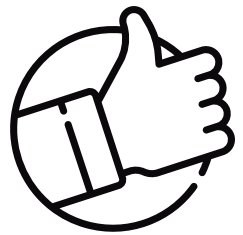
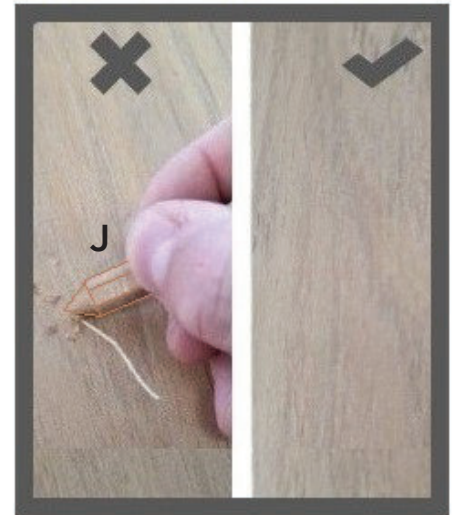





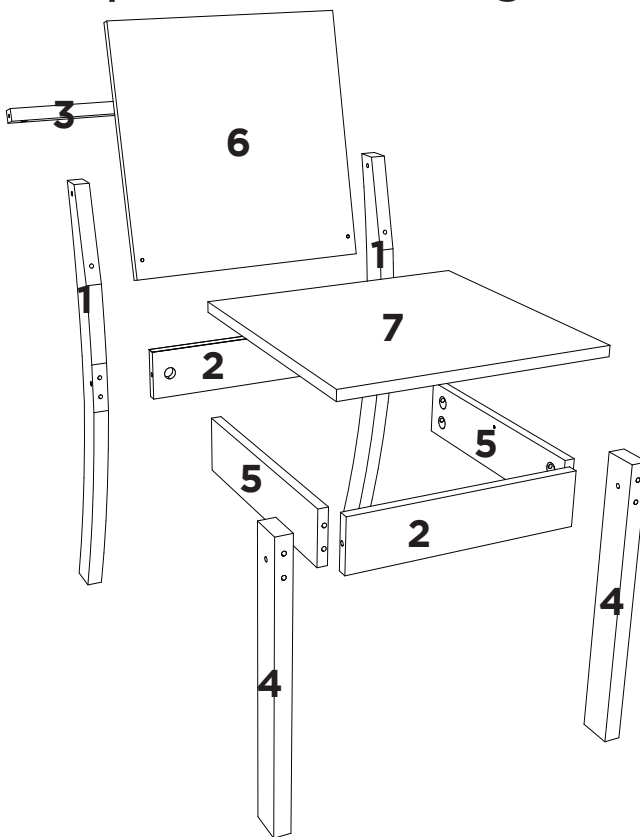

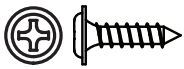

Item	Caixa Caja Box	Qty Ctd Qty	Descrição Descripción Description	Medidas (mm) Dimensions (mm) Size (measurements) (mm)
1	1/1	08	Pé Traseiro Pie trasero Hind Foot	700x130x25
2	1/1	08	Travessa Frontal Plato delantero Front Platter	345x80x15
3	1/1	04	Travessa Traseira Travesaño trasero Rear cross member	345x33x25
4	1/1	08	Pé Frontal Pie delantero Front foot	425x50x25
5	1/1	08	Travessa Lateral Plato lateral Side Platter	345x80x15
6	1/1	04	Encosto Estofado Respaldo tapizado Upholstered backrest	415x415x55
7	1/1	04	Assento Estofado Asiento tapizado Upholstered seat	415x415x55

O volume contém peças para montagem de 4 Cadeiras.
El volumen contiene piezas para montar 4 sillas.
The volume contains parts for mounting 4 Chairs.

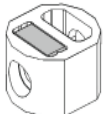
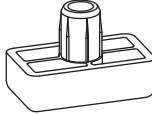

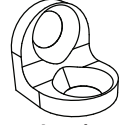
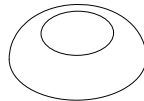
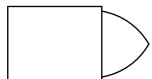
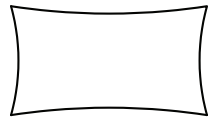
Ferragens | Herrajes | Hardware

A  Parafuso Cab PL 17 Allen 4.14x3,12 (90mm) Tornillo PL 17 Allen 4.14x3.12 (90mm) Screw PL 17 Allen 4.14x3.12 (90mm)	B  Parafuso Cab PL 17 Allen 4.14x3,12 (60mm) Tornillo PL 17 Allen 4.14x3.12 (60mm) Screw PL 17 Allen 4.14x3.12 (60mm)	C  Parafuso 3,5x14mm FLA. Tornillo 3,5x14mm FLA. Screw 3,5x14mm FLA.	D  Porca Cilíndrica Zamac 12x12mm Tuerca Cilíndrica Zamac 12x12mm Zamac Cylindrical Nut 12x12mm
E  Porca meia lua plástica rosca 1/4 1/4 tuerca de media luna de plástico 1/4 plastic half moon nut	F  Sapata Deslizante 15x26x8mm Zapato deslizante 15x26x8mm Sliding Shoe 15x26x8mm	G  Cantoneira Metal 18x18mm 18x18mm esquina de metal Soporte Metal Corner Bracket 18x18mm	H  Cantoneira de Fixação Ángulo de fijación Fixing Angle
I  Tapa Parafuso Soft 17mm Tapón de rosca suave de 17 mm Soft Screw Cap 17mm	J  Giz de correção Tiza de corrección Chalk of correction	K  Sachê de cola Bolsa de pegamento Glue bag	L  Chave Allen llave Allen Allen key