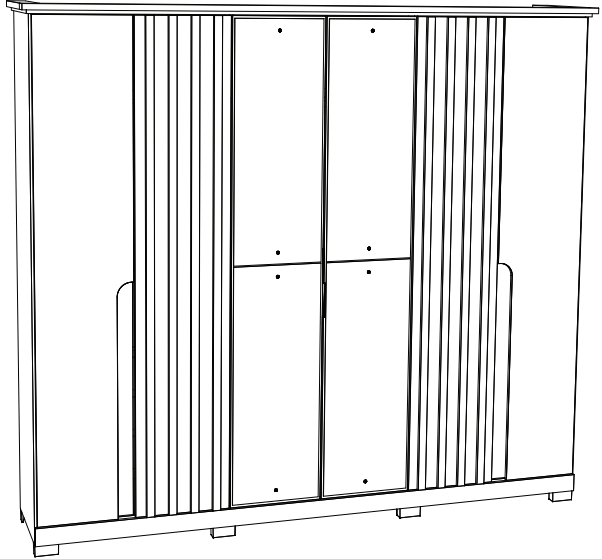
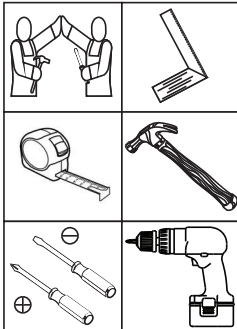

HENNInd. e Com. de Móveis Henn
Mondai - SC - Brasil

☎ +55 49 3674.3500

📷 📧 @moveishenn
www.henn.com.br**INSTRUÇÕES DE
MONTAGEM**INSTRUCCIONES DE MONTAJE
ASSEMBLY INSTRUCTIONS**Roupeiro Napoli 6 Portas 6 Gavetas | Armario Napoli 6 Puertas 6 Cajones |
Wardrobe Napoli 6 Doors 6 Drawers**D308-129 Off White/Nature
D308-169 Cinza/Nature**Requisitos para montagem
Requisitos para la montaje
Assembly Requirements**

Imagens meramente ilustrativas,
não acompanha o produto.
Imágenes ilustrativas, no incluidas
con el producto.
Illustrative images, not included
with the product.

AVISO

Para limpeza de seu móvel, use uma flanela seca ou umedecida, e não utilize produtos químicos que possam danificar seu produto.

SISTEMA DE MONTAGEM

O sistema de montagem dos produtos, funciona de acordo com a ordem crescente dos números indicados no desenho. Ex: 01, 02, 03, 04... até a conclusão da montagem.

ASSISTÊNCIA TÉCNICA

Para solicitação de Assistência Técnica você consumidor deverá entrar em contato com o Lojista a qual você realizou a compra deste produto e solicitar a assistência técnica das peças avariadas. A garantia abrange todas as peças, partes e componentes que eventualmente venham apresentar defeito de fabricação no prazo de 03 (três) meses, contando a partir da entrega do produto ao consumidor, mediante nota fiscal de compra. Se houver qualquer alteração na estrutura do produto ou ocorrer defeito por negligência do montador/consumidor em relação a instrução de montagem e manuseio, não será fornecido assistência técnica gratuita.

ADVERTENCIA

Para limpeza de su móvil, use una flanela seca o húmeda, y no utilice productos químicos que puedan dañar su producto.

SISTEMA DE MONTAJE

El sistema de montaje de los productos funciona de acuerdo con el orden creciente de los números indicados en el dibujo. Ej.: 01, 02, 03, 04... hasta la conclusión del montaje.

ASISTENCIA TÉCNICA

Para solicitar Asistencia Técnica, el consumidor debe comunicarse con el Comercio que usted realizó la compra de este producto y solicita asistencia técnica para las partes dañadas. La garantía cubre todas las partes, piezas y componentes que eventualmente puedan presentar defecto de fabricación en el plazo de 03 (tres) meses, contados a partir de la entrega del producto al consumidor, mediante factura de compra. Si se produce algún cambio en la estructura del producto o se produce un defecto por negligencia del montador/consumidor en relación con las instrucciones de montaje y manipulación, no se prestará asistencia técnica gratuita.

NOTICE

To clean your furniture, use a dry or wet cloth, and do not use chemicals that may damage your product.

ASSEMBLY SYSTEM

The products' assembly system works according to the increasing order of the indicated numbers. For example: 01, 02, 03, 04 ... to the end of the assembly.

TECHNICAL ASSISTANCE

To request Technical Assistance, the consumer must contact the retailer from whom you purchased this product and request technical assistance for the damaged parts. The warranty covers all parts, parts and components that may eventually present a manufacturing defect within a period of 03 (three) months, counting from the delivery of the product to the consumer, by means of a purchase invoice. If there is any change in the structure of the product or defect occurs due to negligence of the assembler/consumer in relation to the assembly and handling instruction, free technical assistance will not be provided.

ACESSÓRIOS | ACCESORIOS | ACCESSORIES

A



x4

B



x40

C



x33

D



x12

E



x16

F



x53

G



x12

H

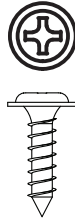

x108

I



x96

J

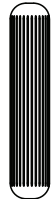

x114

K



x204

L

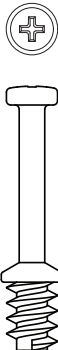

x2

M



x2

N



x12

O

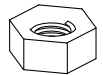

x16

Parafusos em escala
Tornillos escalados
Scaled screws

1:1

ACESSÓRIOS | ACCESORIOS | ACCESSORIES

P

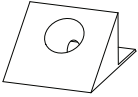

x12

Q

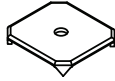

x55

R



x4

S

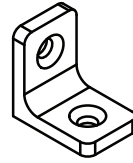

x4

T

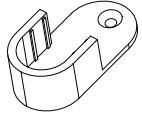

x4

U

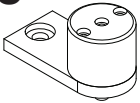

x12

V

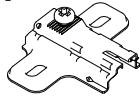

x24

W

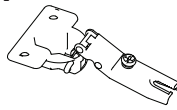

x24

X

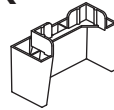

x8

Y

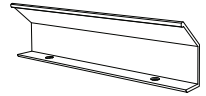

x2

Z



x6

AA



x2

AB



x3

AC

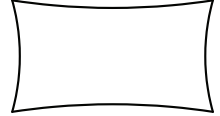

x3

AD

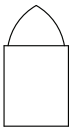

x3

AE

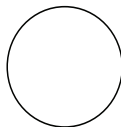

x2

AF



x106

AG

HENN

x1

LISTA DE PEÇAS | LISTA DE PIEZAS | LIST OF PIECES™/D308-

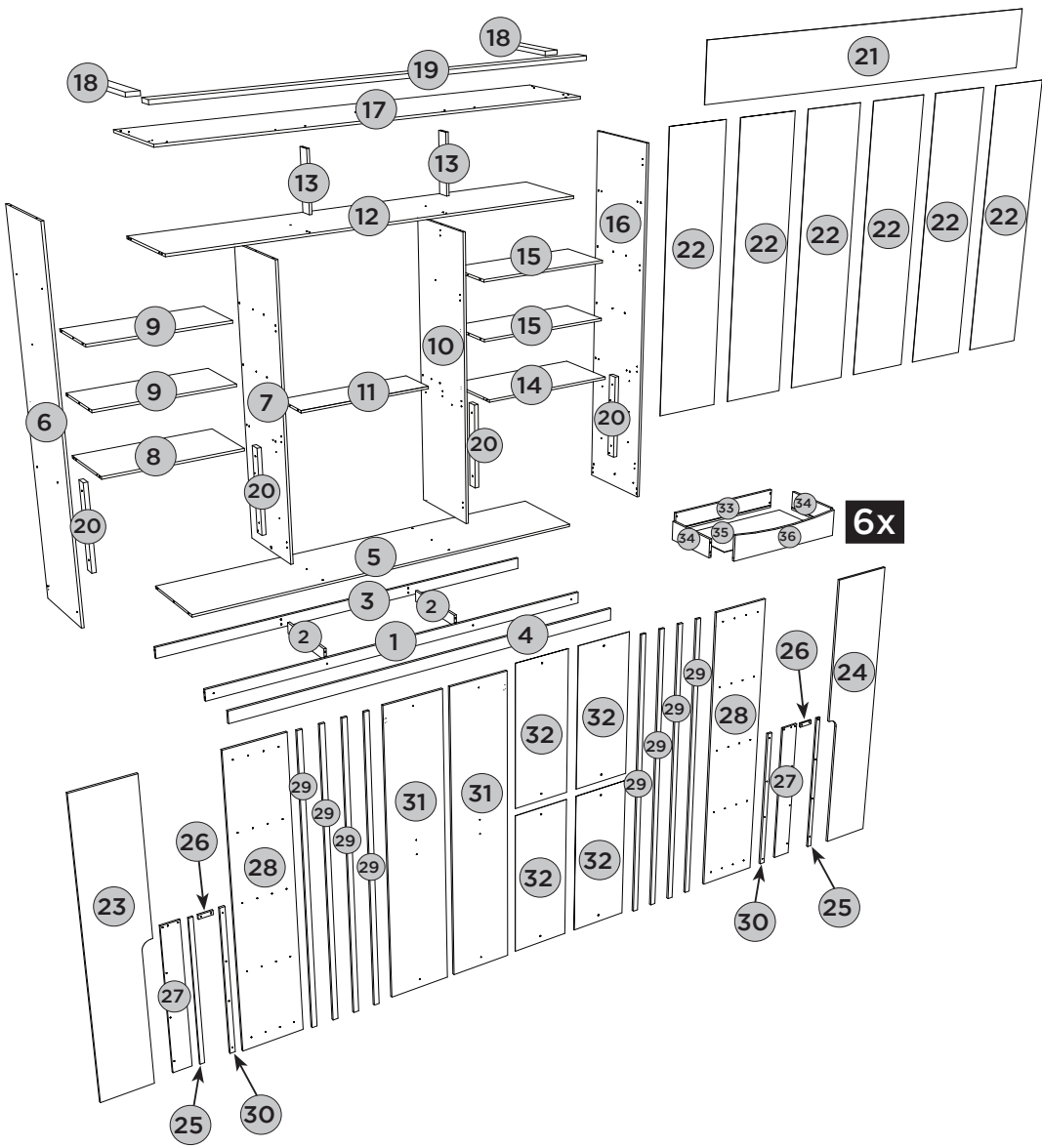

Item	Caixa Caja Box	Qty Ctd Qty	Descrição Descripción Description	Dimensões (mm) Dimensiones (mm) Dimensions (mm)		
				Comprimento Largo Length	Largura Ancho Width	Espessura Grosor Thickness
1	2/6	1	RODAPÉ FRONTAL FALDÓN DELANTERO FRONT SKIRTING	2469	73	15
2	3/6	2	TRAVESSA DO RODAPÉ PLACA DE RODAPIÉ SKIRTING PLATE	446	73	15
3	2/6	1	RODAPÉ TRASEIRO REPOSAPIÉS TRASERO BACK FOOTBOARD	2469	73	15
4	2/6	1	MOLDURA FRONTAL MARCO FRONTAL FRONT FRAME	2497	78	15
5	2/6	1	BASE BASE BASE	2469	480	15
6	4/6	1	LATERAL ESQUERDA LADO IZQUIERDO LEFT SIDE	2215	480	15
7	3/6	1	DIVISÃO ESQUERDA DIVISIÓN IZQUIERDA LEFT DIVISION	1762	480	15
8=14	1/6	1	TAMPO DA GAVETA PARTE SUPERIOR DEL CAJÓN DRAWER TOP	813	400	15
9=15	3/6	2	PRATELEIRA ESTANTE SHELF	813	350	15
10	3/6	1	DIVISÃO DIREITA DIVISIÓN DERECHA RIGHT DIVISION	1762	480	15
11	4/6	1	PRATELEIRA DO VARÃO ESTANTE DE LA BARRA ROD SHELF	813	250	15
12	2/6	1	CHÃO DO MALEIRO REPISA SUPERIOR FLOOR OF MALEIRO	2469	480	15
13	3/6	2	RIPA DO MALEIRO TRAVESAÑO SUPERIOR MALEIRO'S LATH	350	73	15
14=8	1/6	1	TAMPO DA GAVETA PARTE SUPERIOR DEL CAJÓN DRAWER TOP	813	400	15
15=9	3/6	2	PRATELEIRA ESTANTE SHELF	813	350	15
16	4/6	1	LATERAL DIREITA LADO DERECHO RIGHT SIDE	2215	480	15
17	2/6	1	TAMPO SUPERIOR TAPA SUPERIOR UPPER TOP	2519	497	15
18	2/6	2	MOLDURA LATERAL MARCO LATERAL SIDE FRAME	440	80	25
19	2/6	1	MOLDURA FRONTAL SUPERIOR MARCO SUPERIOR DELANTERO UPPER FRONT FRAME	2559	80	25
20	2/6	4	RIPA LATERAL CINTA LATERAL SIDE RIBBON	525	58	25
21	2/6	1	FUNDO SUPERIOR FONDO TOP TOP FUND	2491	372	3
22	4/6	6	FUNDO FONDO BOTTOM	1784	411	3
23	5/6	1	PORTA ESQUERDA PUERTA IZQUIERDA LEFT DOOR	2129	409	15
24	5/6	1	PORTA DIREITA PUERTA DERECHA RIGHT DOOR	2129	409	15
25	4/6	2	TRAVESSA TRAVESAÑO CROSSBAR	1065	30	12
26	4/6	2	TRAVESSA MENOR TRAVESAÑO MENOR SMALLER CROSSBAR	95	30	12
27	4/6	2	APLIQUE DA PORTA APLICAR DE PUERTA APLY DOOR	1065	125	12
28	5/6	2	PORTA PUERTA DOOR	2129	409	15
29	4/6	8	MOLDURA FRONTAL PORTA MARCO DELANTERO DE LA PUERTA DOOR FRONT FRAME	2129	35	15
30	4/6	2	TRAVESSA MAIOR TRAVESAÑO MÁS GRANDE CROSSBAR BIGGER	1065	35	15
31	6/6	2	PORTA ESPELHO SOPORTE ESPEJO MIRROR DOOR	2129	409	15
32	6/6	4	ESPELHO ESPEJO MIRROR	1050	390	3
33	1/6	6	RIPA DE TRÁS TRAVESAÑO TRASERO REAR CLAPBOARD	743	122	15
34	1/6	12	LADO DE GAVETA LATERAL DEL CAJÓN DRAWER SIDE	350	122	15
35	1/6	6	FUNDO DE GAVETA RECORTADO RECORTAR EL FONDO DEL CAJÓN CROPED DRAWER BOTTOM	724	361	3
36	1/6	6	FRENTE DE GAVETA FRENTE DEL CAJÓN DRAWER FRONT	755	170	15



PEÇAS REQUERIDAS

1	RODAPÉ FRONTAL	x1
2	TRAVESSA DO RODAPÉ	x2
3	RODAPÉ TRASEIRO	x1
13	RIPA DO MALEIRO	x2

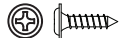
ACESSÓRIOS REQUERIDOS

H		04
J		20
S		04



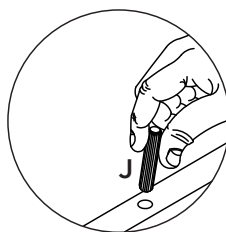
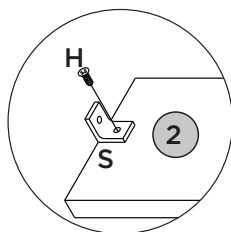
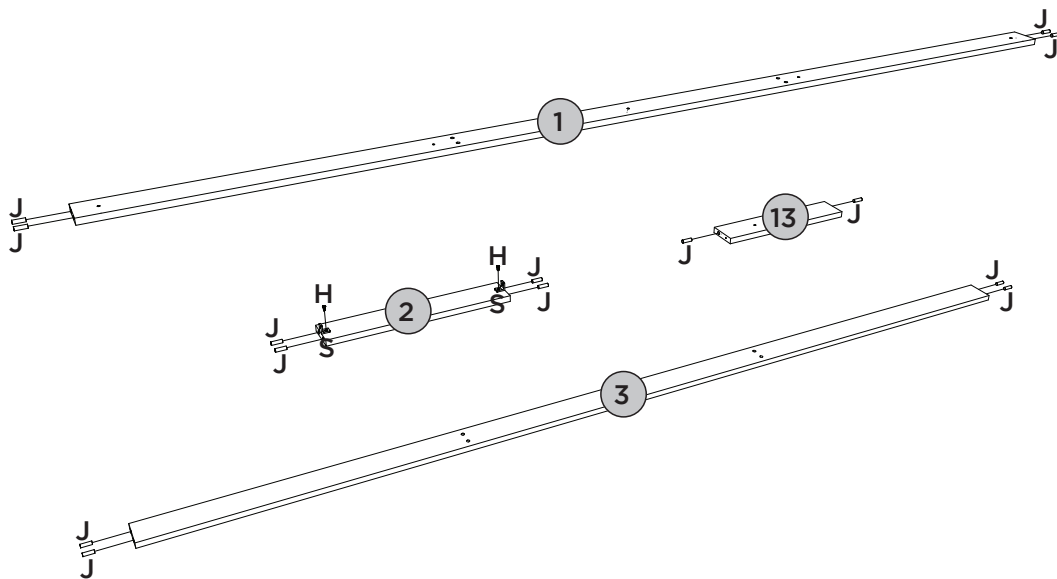
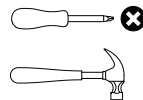



FERRAMENTAS NECESSÁRIAS

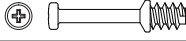

PEÇAS REQUERIDAS

5	BASE	x1
6	LATERAL ESQUERDA	x1

ACESSÓRIOS REQUERIDOS

H		11
J		04
L		02
R		04
U		03
V		04



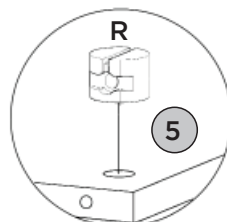
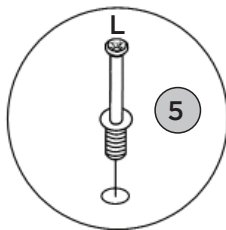
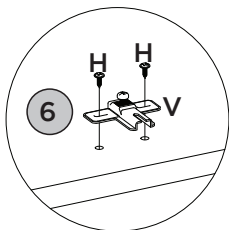
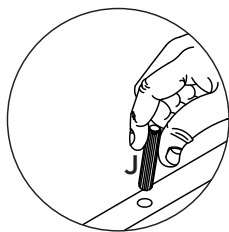
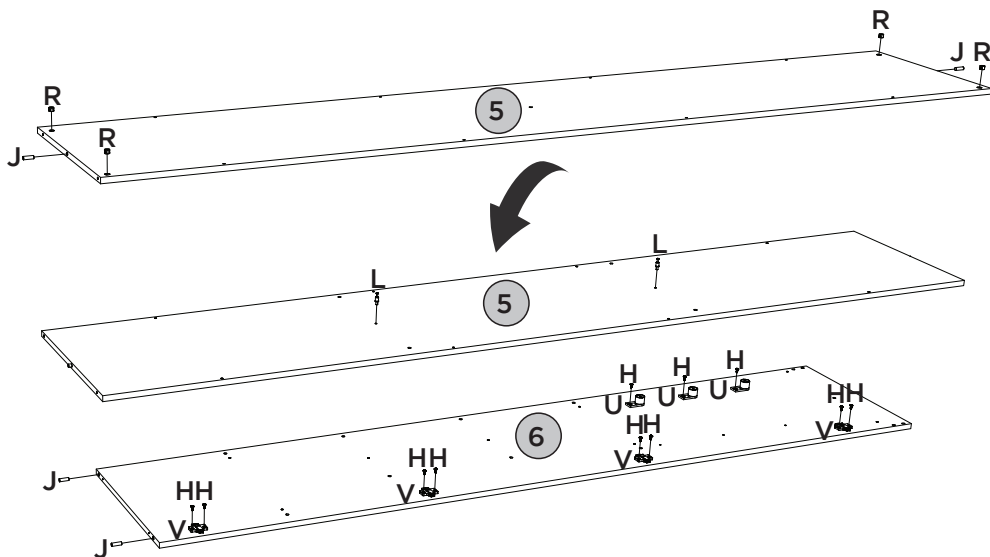
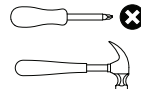

FERRAMENTAS NECESSÁRIAS



PEÇAS REQUERIDAS

7	DIVISÃO ESQUERDA	x1
---	------------------	----

ACESSÓRIOS REQUERIDOS

H		03
I		04
J		04
T		02
U		03

FERRAMENTAS NECESSÁRIAS

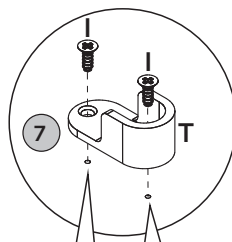
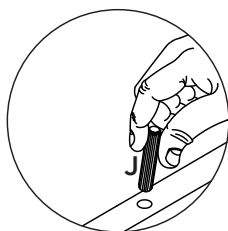
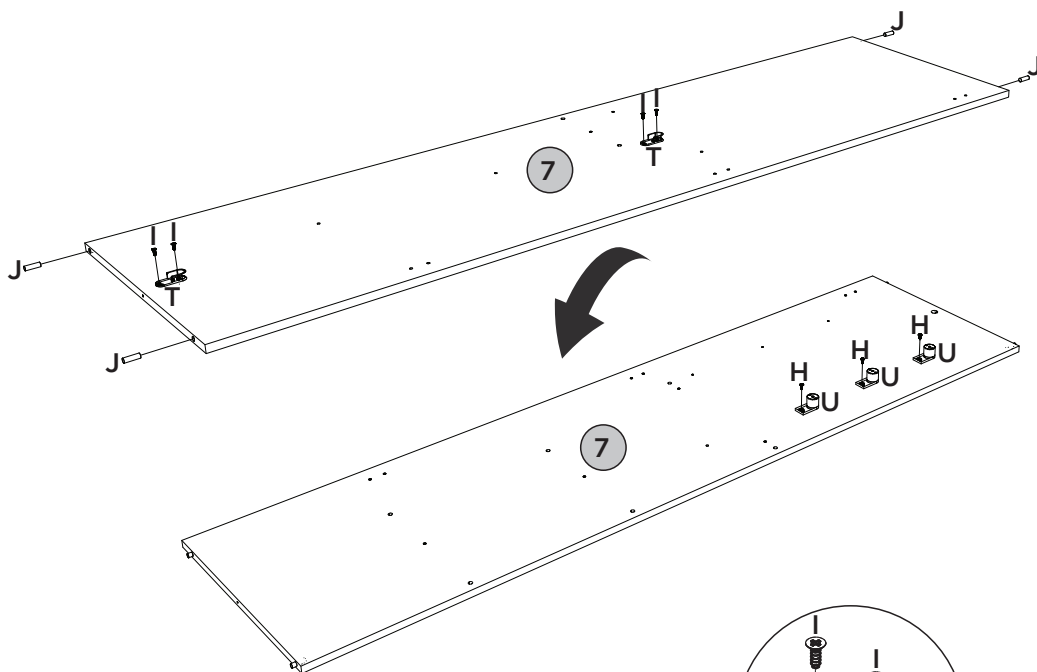
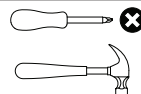

**Observe:
Furos
pré-marcados**

PASSO 4

ITM/D308-

PEÇAS REQUERIDAS

8=14	TAMPO DA GAVETA	x2
9=15	PRATELEIRA	x4
11	PRATELEIRA DO VARÃO	x1

ACESSÓRIOS REQUERIDOS

J		28
---	---	----



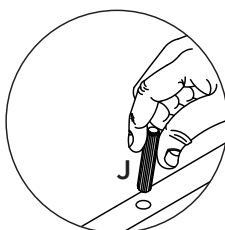
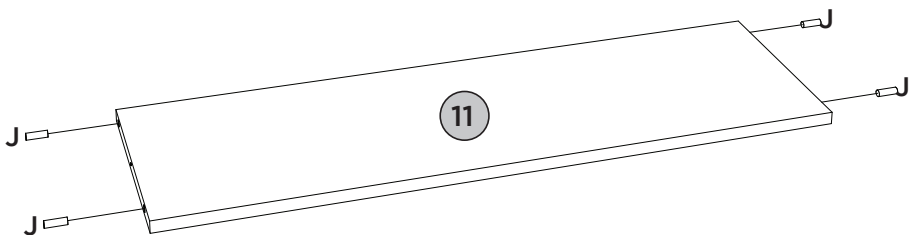
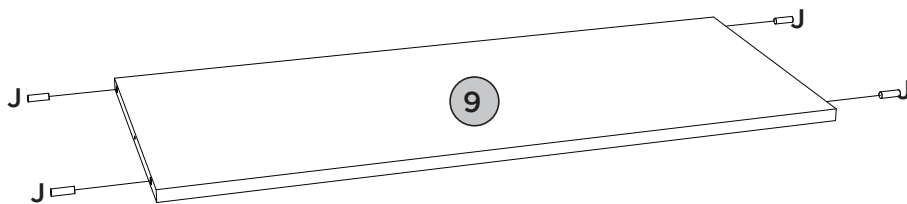
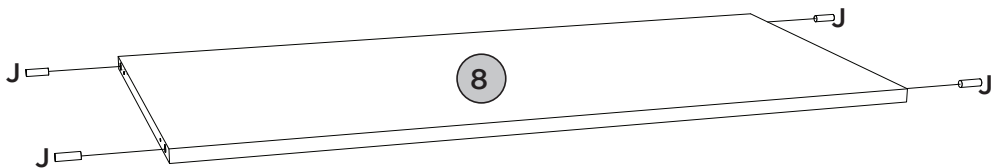
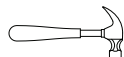



FERRAMENTAS NECESSÁRIAS



PEÇAS REQUERIDAS

10	DIVISÃO DIREITA	x1
12	CHÃO DO MALEIRO	x1
16	LATERLA DIREITA	x1

ACESSÓRIOS REQUERIDOS

H		14
I		04
J		10
T		02
U		06
V		04

FERRAMENTAS NECESSÁRIAS

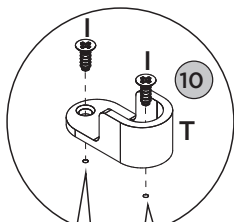
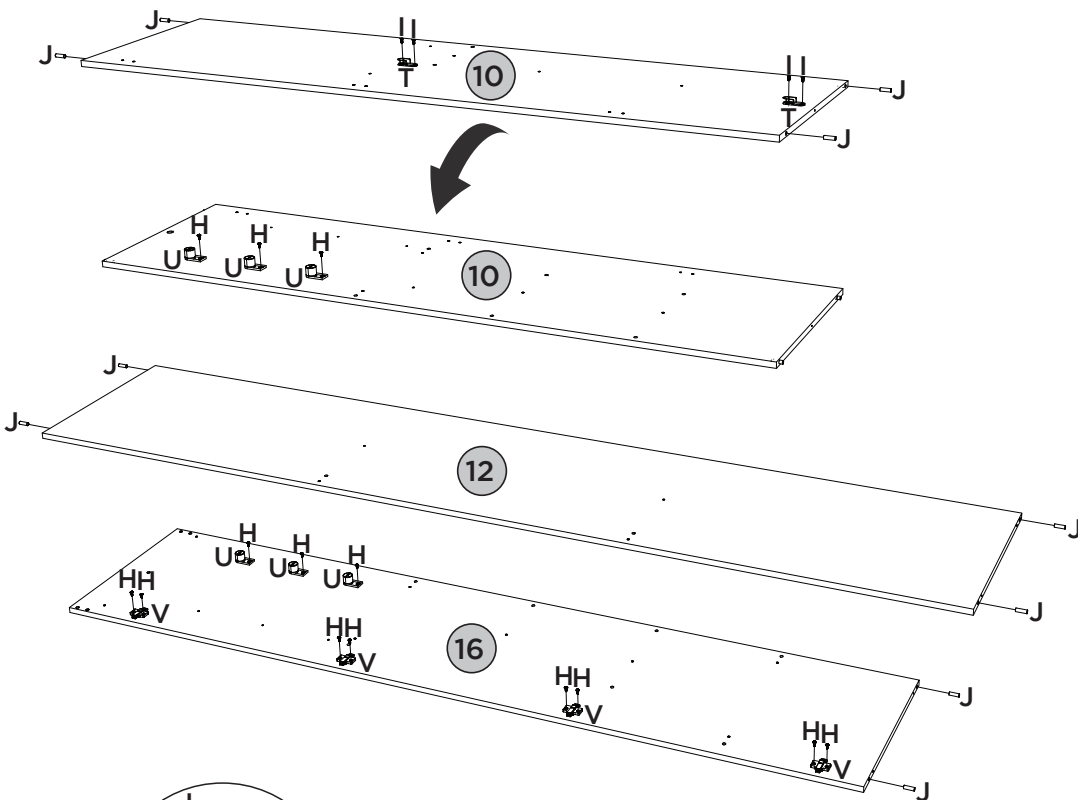
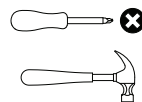

**Observe:
Furos
pré-marcados**

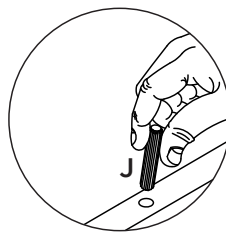
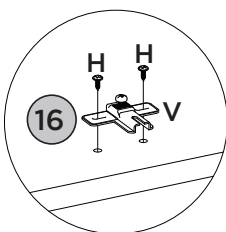



PASSO 6

ITM/D308-

PEÇAS REQUERIDAS

1	RODAPÉ FRONTAL	x1
2	TRAVESSA DO RODAPÉ	x2
3	RODAPÉ TRASEIRO	x1
4	MOLDURA FRONTAL	x1

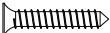
ACESSÓRIOS REQUERIDOS

F			05
H			04



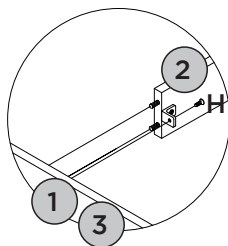
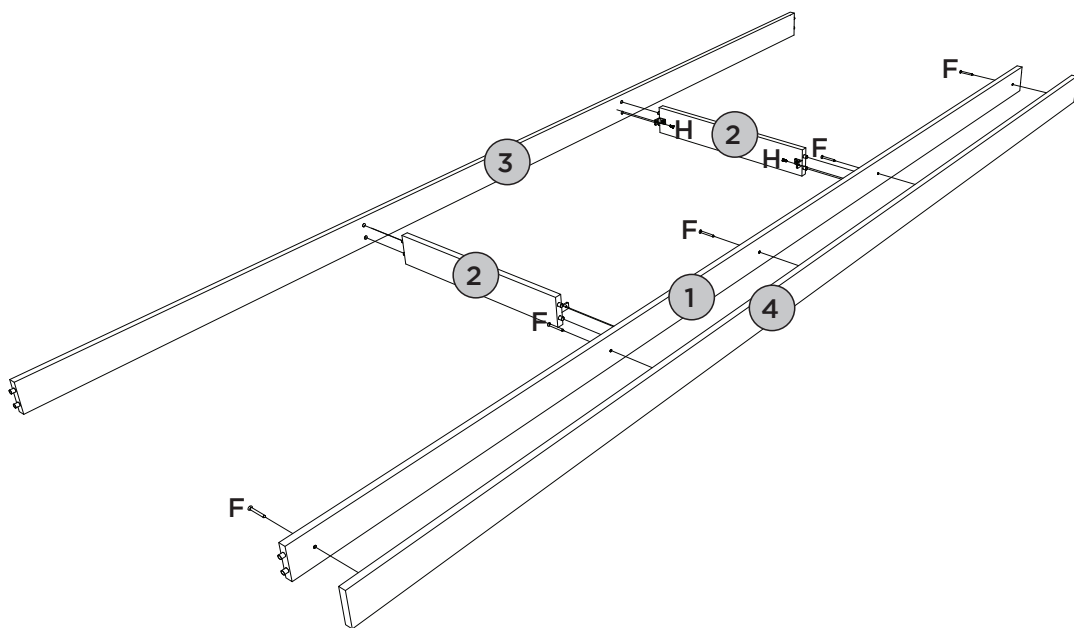
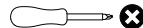

FERRAMENTAS NECESSÁRIAS



PEÇAS REQUERIDAS

5	BASE	x1
6	LATERAL ESQUERDA	x1
7	DIVISÃO DIREITA	x1
8	TAMPO DA GAVETA	x1
9	PRATELEIRA	x2

ACESSÓRIOS REQUERIDOS

A		02
B		16
H		24
M		01
X		08

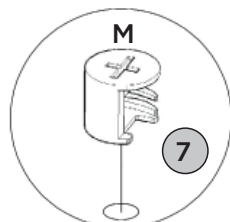
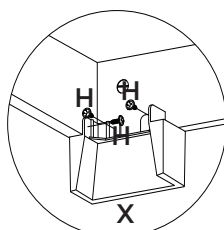
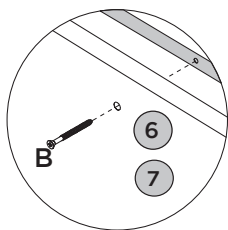
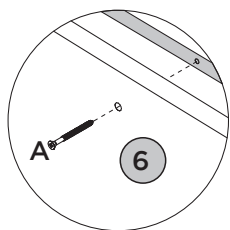
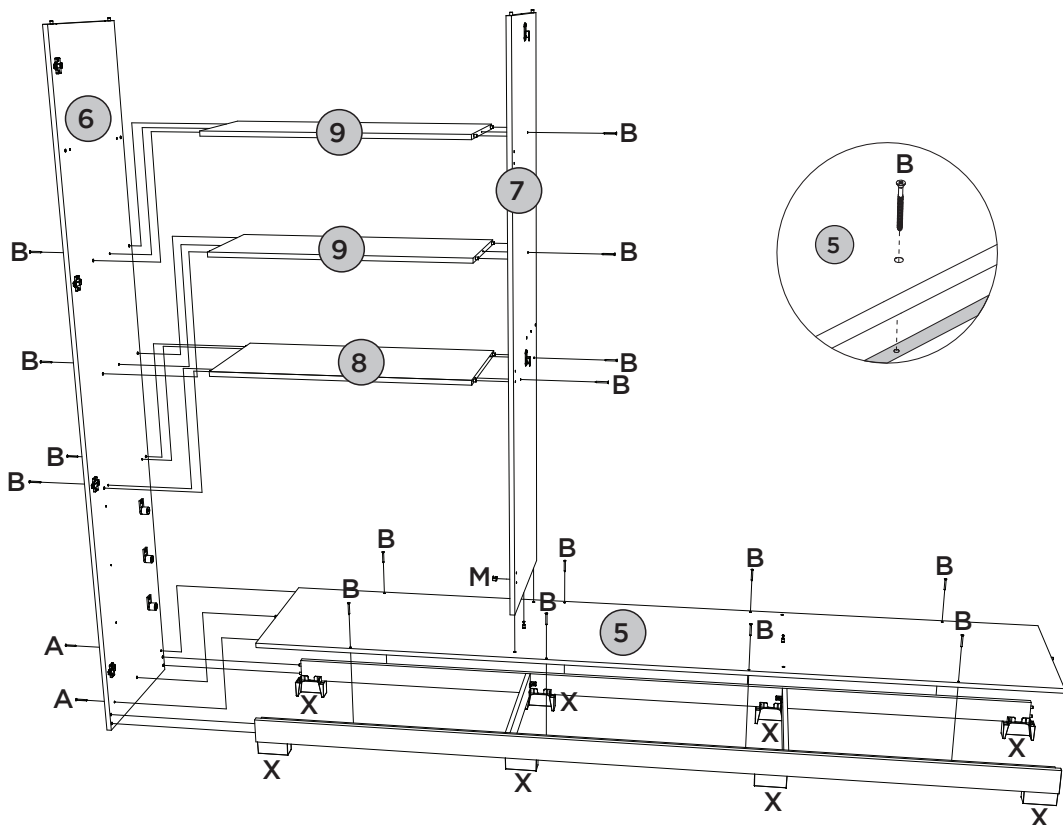
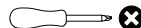

FERRAMENTAS NECESSÁRIAS



PEÇAS REQUERIDAS

10	DIVISÃO DIREITA	x1
11	PRATELEIRA DO VARÃO	x1

ACESSÓRIOS REQUERIDOS

B		02
M		01

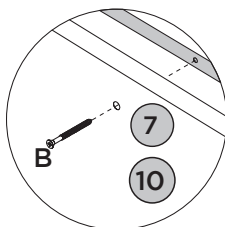
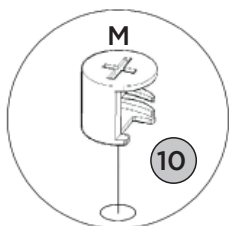
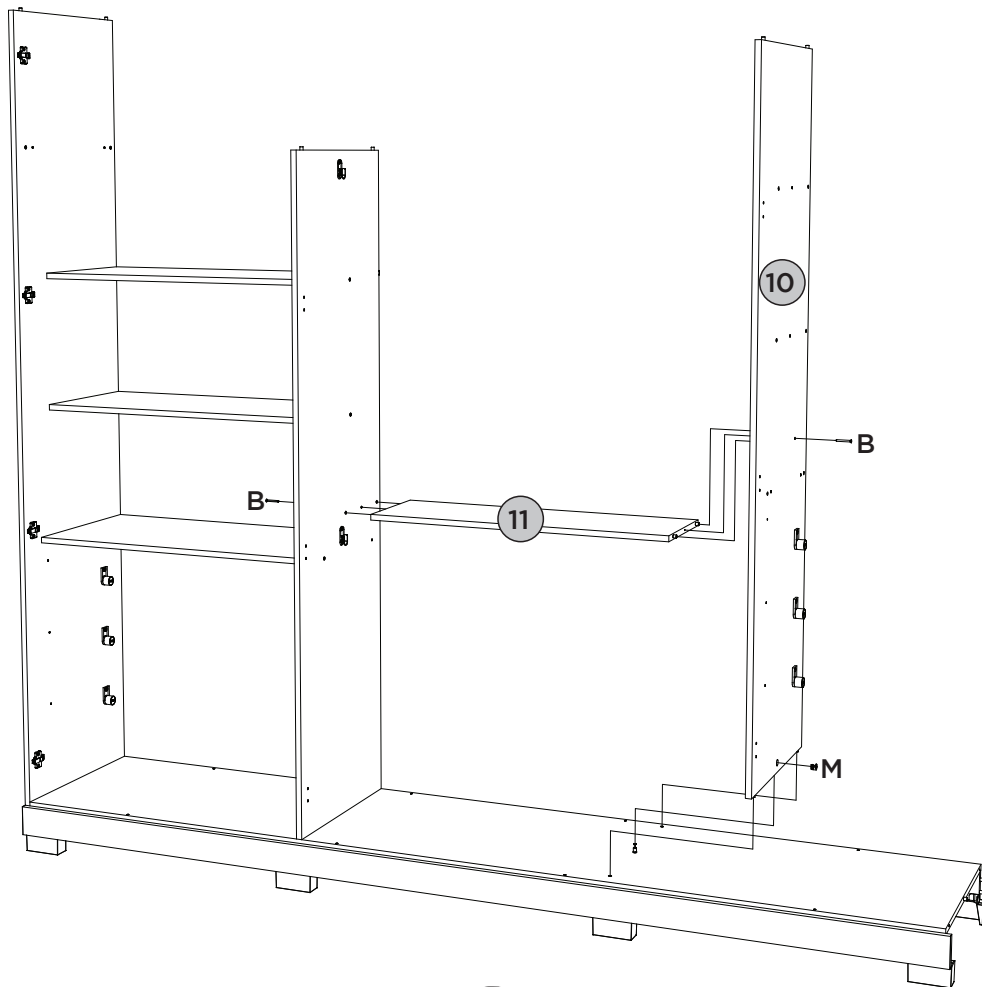
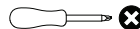

FERRAMENTAS NECESSÁRIAS



PEÇAS REQUERIDAS

12	CHÃO DO MALEIRO	x1
13	RIPA DO MALEIRO	x2
14	TAMPO DA GAVETA	x1
15	PRATELEIRA	x2
16	LATERAL DIREITA	x1
17	TAMPO SUPERIOR	x1

ACESSÓRIOS REQUERIDOS

A		02
B		22

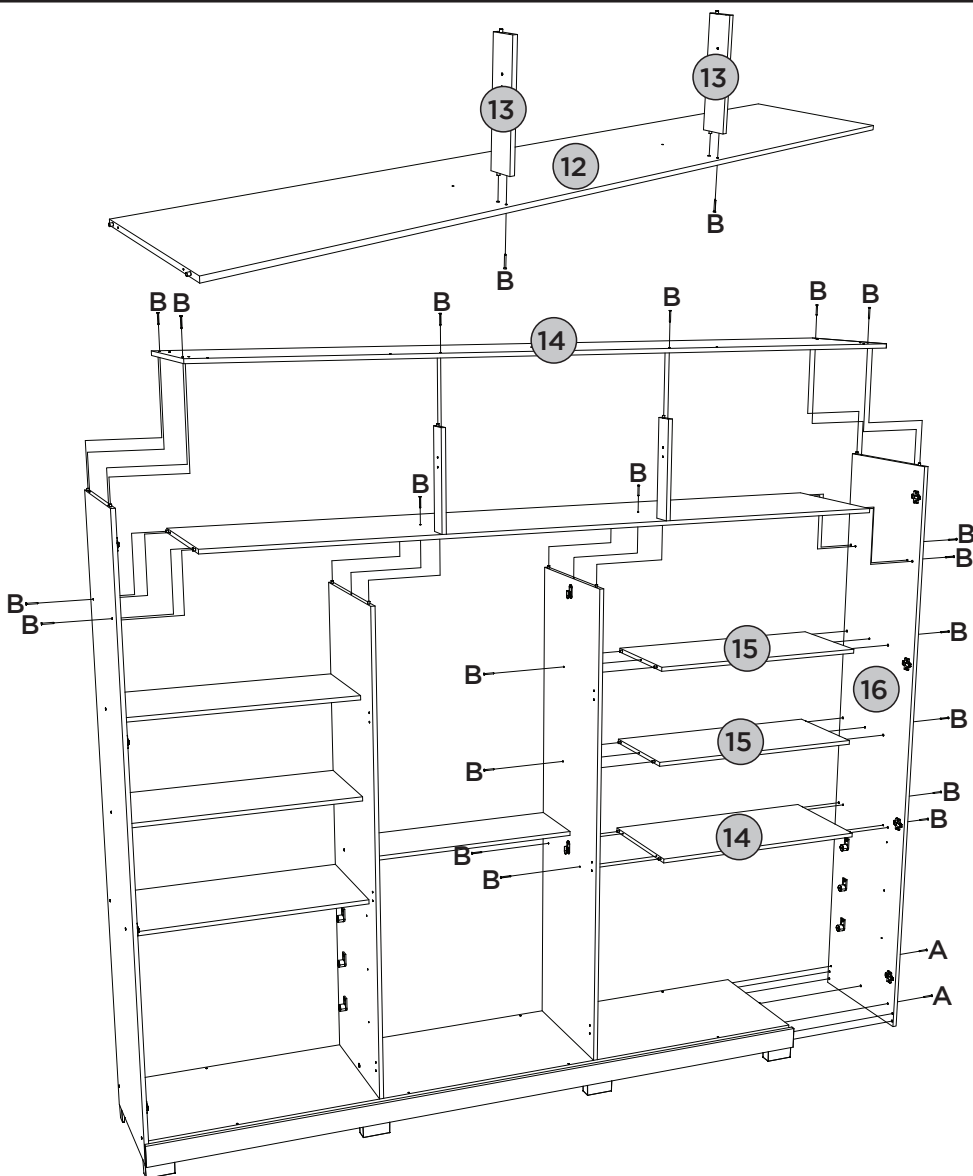
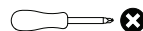

FERRAMENTAS NECESSÁRIAS



PEÇAS REQUERIDAS

18	MOLDURA LATERAL	x2
19	MOLDURA FRONTAL SUPERIOR	x1
20	RIPA LATERAL	x4

ACESSÓRIOS REQUERIDOS

C			21
---	---	---	----

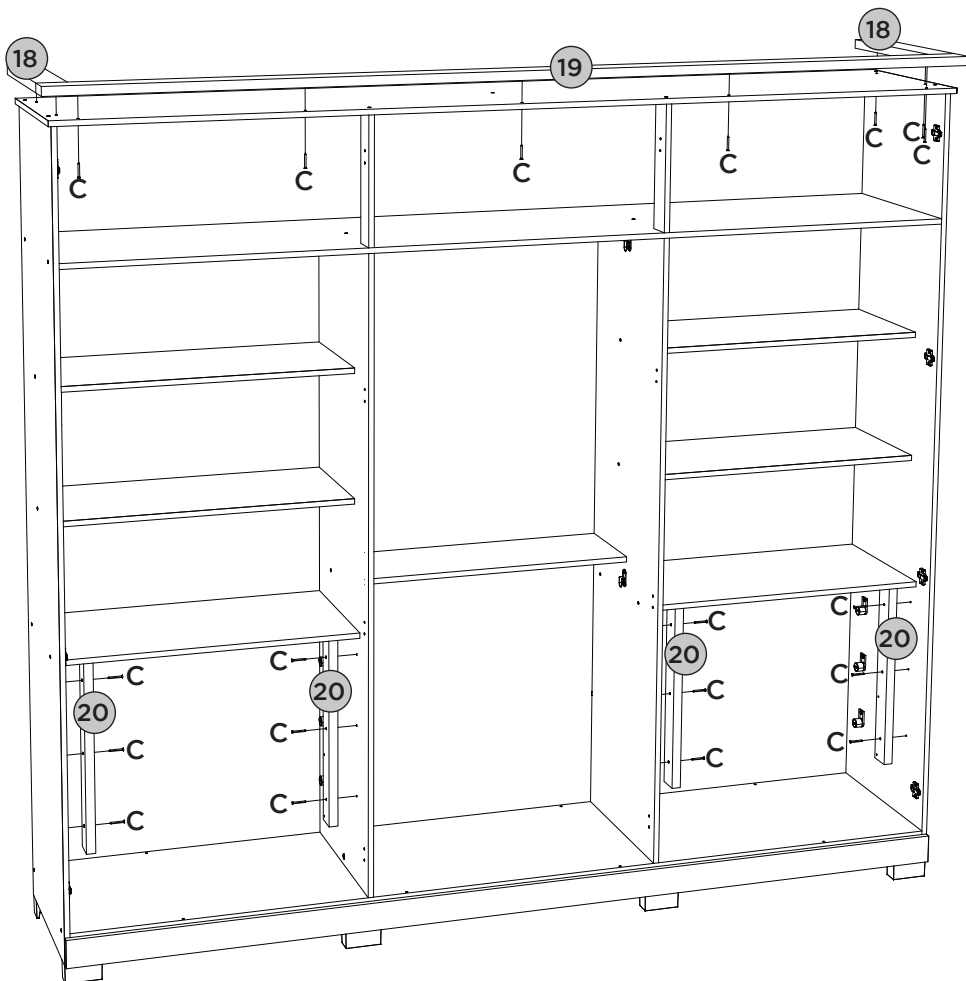
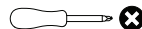

FERRAMENTAS NECESSÁRIAS



PEÇAS REQUERIDAS

21	FUNDO SUPERIOR	x1
22	FUNDO	x6

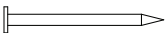
ACESSÓRIOS REQUERIDOS

K		204
Q		55
AB		03



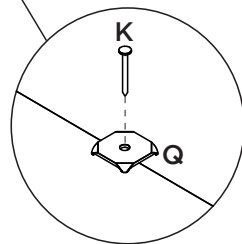
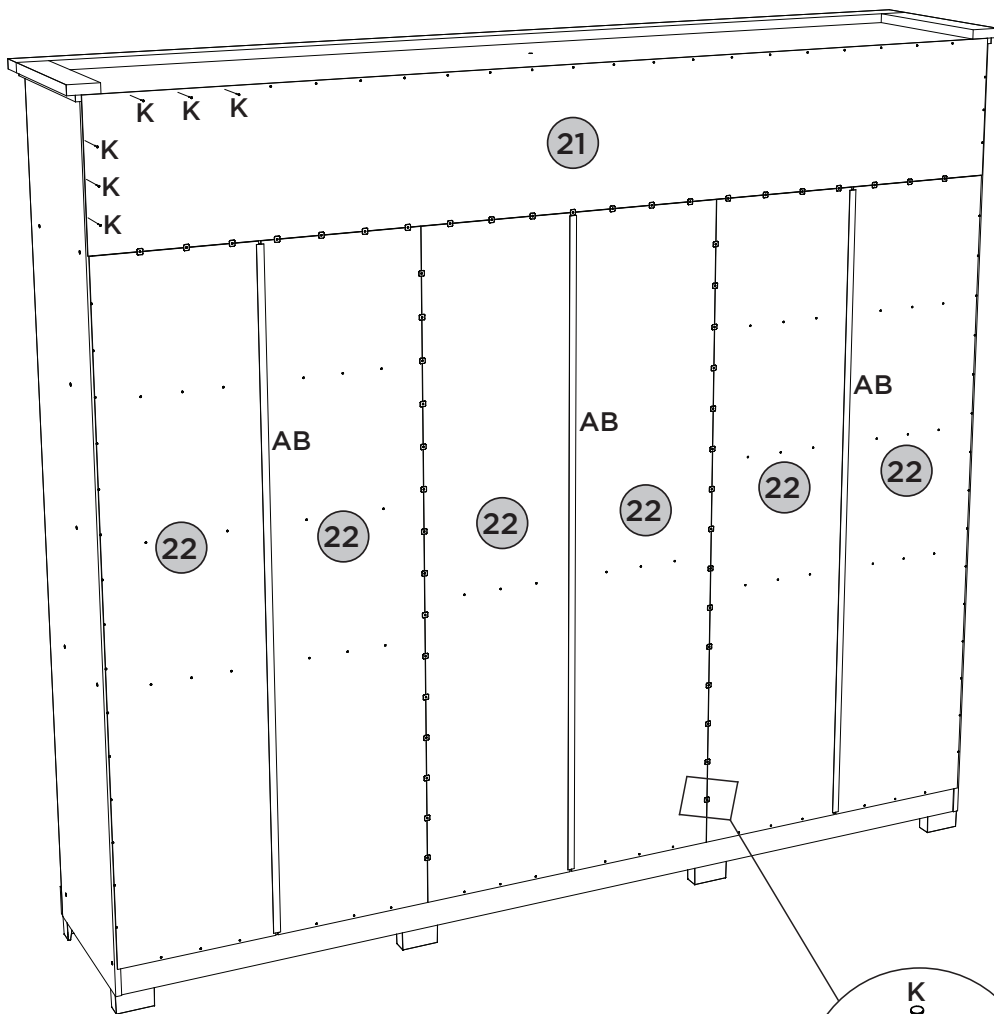
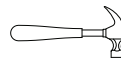

FERRAMENTAS NECESSÁRIAS



PEÇAS REQUERIDAS

23	PORTA ESQUERDA	x1
24	PORTA DIREITA	x1
28	PORTA	x2
31	PORTA ESPELHO	x2

ACESSÓRIOS REQUERIDOS

H		48
I		04
W		24
Y		02

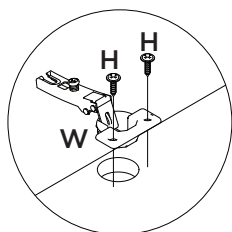
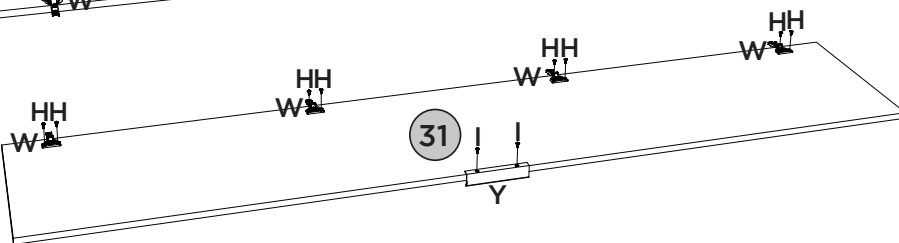
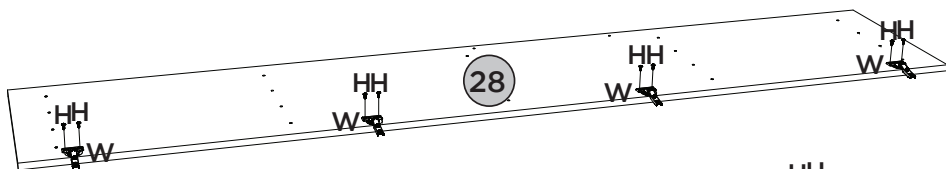
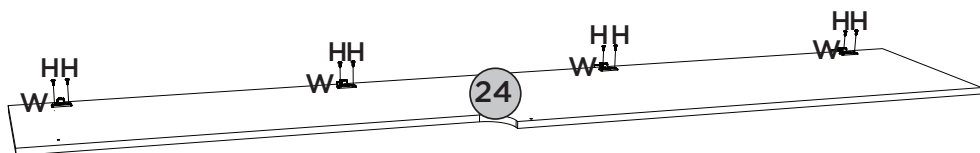
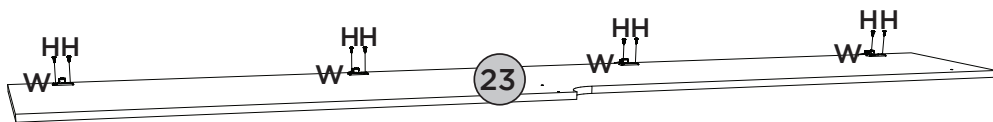
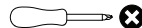
FERRAMENTAS NECESSÁRIAS

Vídeo: Instalar e regular Dobradiças



Video: Instale y ajuste las bisagras

Video: Install and adjust hinges

PEÇAS REQUERIDAS

23	PORTA ESQUERDA	x1
24	PORTA DIREITA	x1
25	TRAVESSA	x2
26	TRAVESSA MENOR	x2
27	APLIQUE PORTA	x2
28	PORTA	x2
29	MOLDURA FRONTAL PORTA	x8
30	TRAVESSA MAIOR	x2

ACESSÓRIOS REQUERIDOS

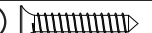
C			12
F			48

FERRAMENTAS NECESSÁRIAS

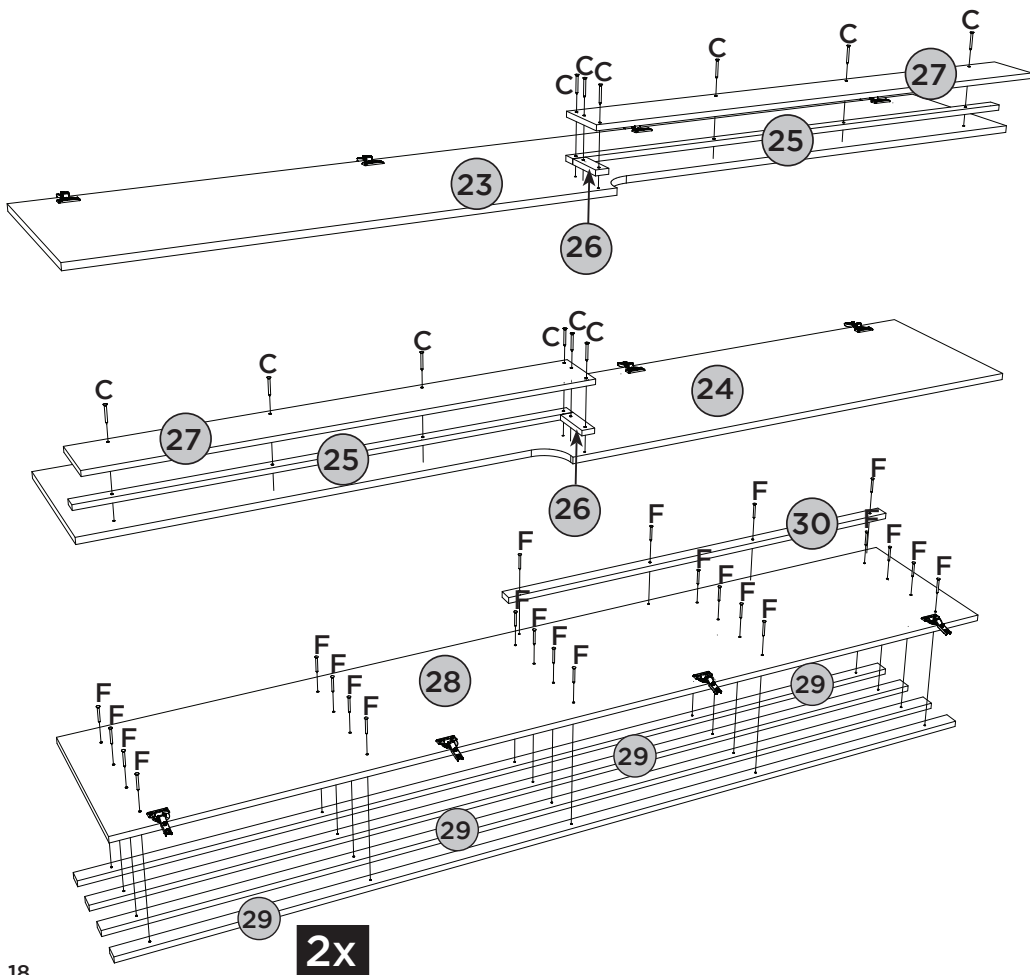
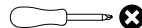







2x

PEÇAS REQUERIDAS

23	PORTA ESQUERDA	x1
24	PORTA DIREITA	x1
28	PORTA	x2
31	PORTA ESPELHO	x2
32	ESPELHO	x4

ACESSÓRIOS REQUERIDOS

E		16
I		24
O		16
V		16
Z		06
AA		02

FERRAMENTAS NECESSÁRIAS

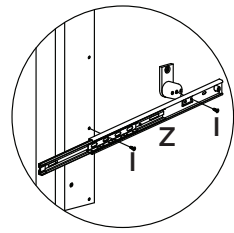
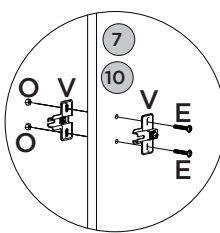
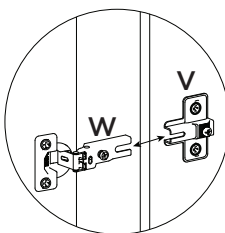
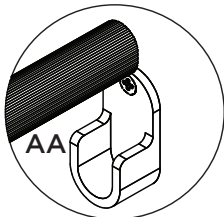
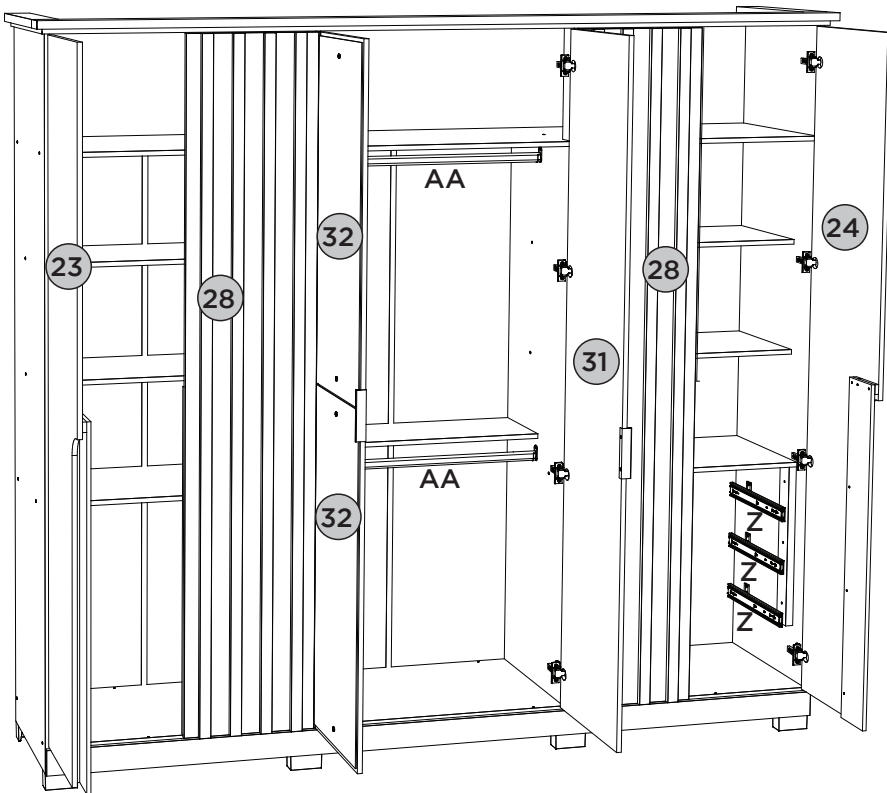
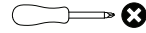

PEÇAS REQUERIDAS

34	LADO DE GAVETA	x12
----	----------------	-----

ACESSÓRIOS REQUERIDOS

J		48
AC		

FERRAMENTAS NECESSÁRIAS

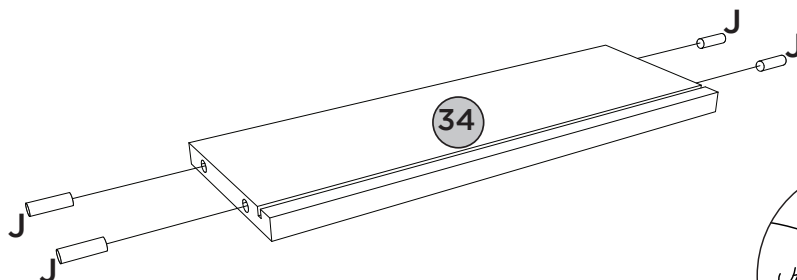
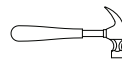

PASSO 16

PEÇAS REQUERIDAS

33	RIPA DE TRÁS	x6
34	LADO DE GAVETA	x12

ACESSÓRIOS REQUERIDOS

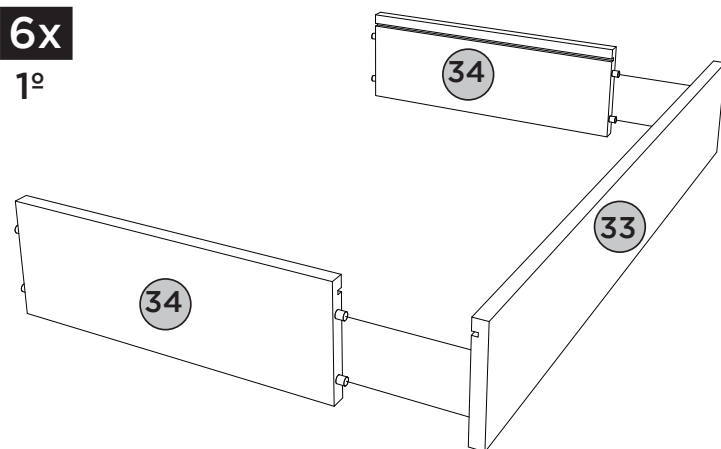

AC		
----	---	--



PEÇAS REQUERIDAS





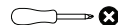
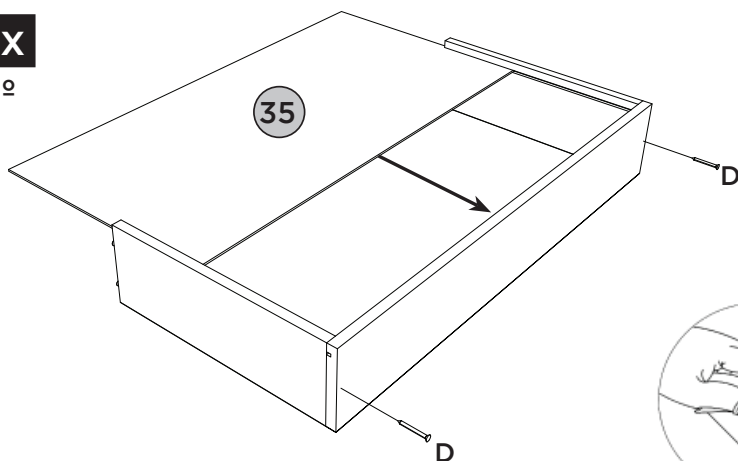
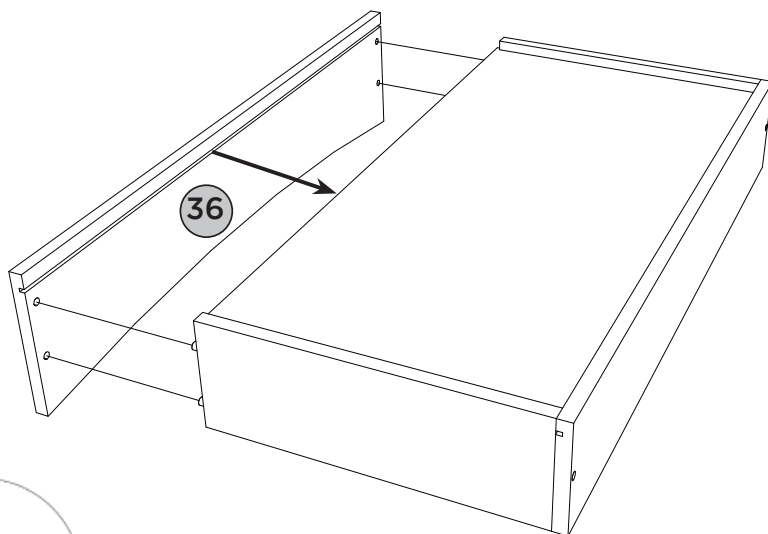

35	FUNDO DE GAVETA RECORTADO	x6
36	FRENTE DE GAVETA	x6

ACESSÓRIOS REQUERIDOS

D			12
AC			

FERRAMENTAS NECESSÁRIAS

6x
2º

6x
3º

ACESSÓRIOS REQUERIDOS

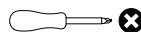
G			12
I			60
N			12
P			12
Z			06

FERRAMENTAS NECESSÁRIAS



6x

4º

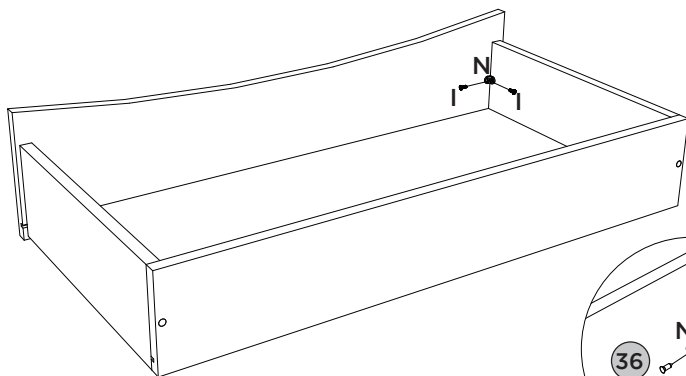

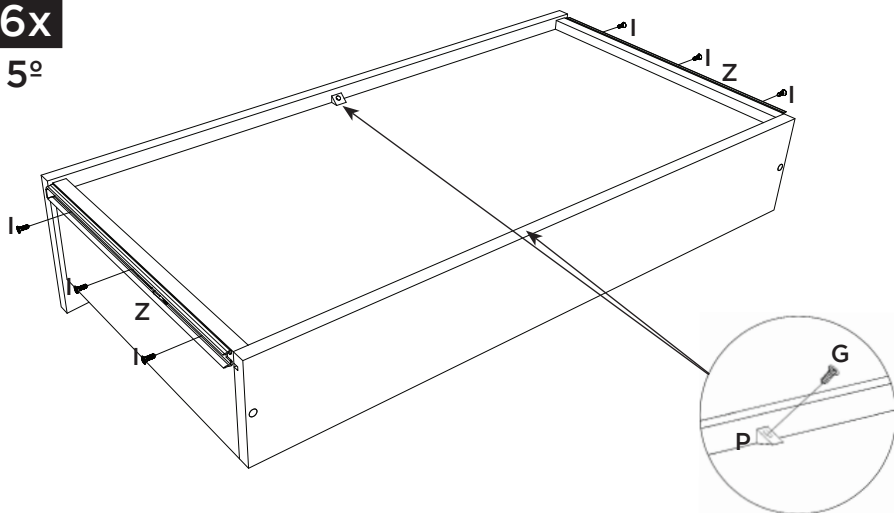

6x

5º



ACESSÓRIOS REQUERIDOS

AD		03
AE		02
AF		98
AG	HENN	01

Pesos máximos recomendados com carga distribuída
 Peso máximo recomendado con la carga distribuida
 Recommended maximum weight with distributed load.

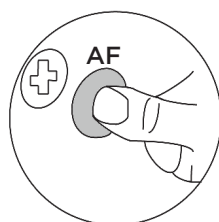
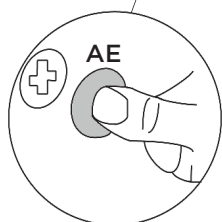
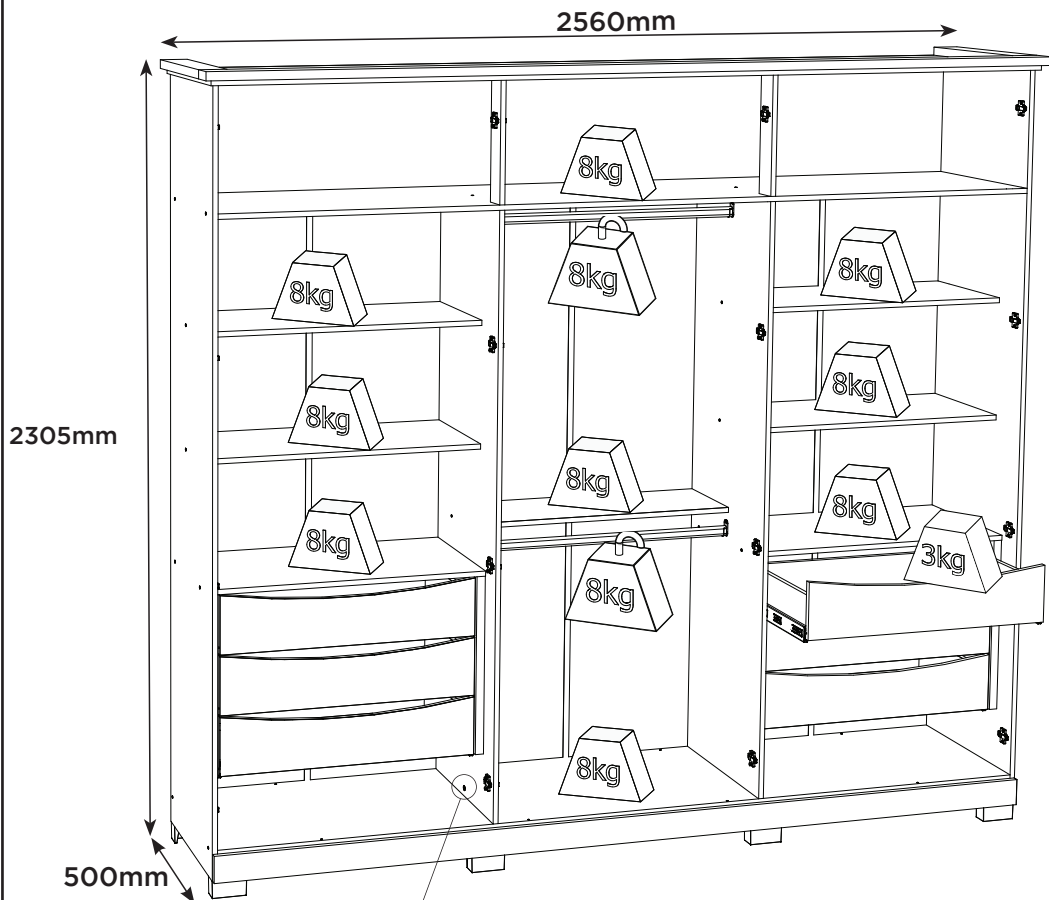

PERFECT CORRECTION
 CORRECCIÓN PERFECTA

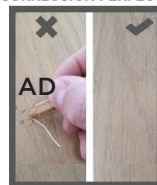

Producto Concluído
Producto terminado
Finished Product

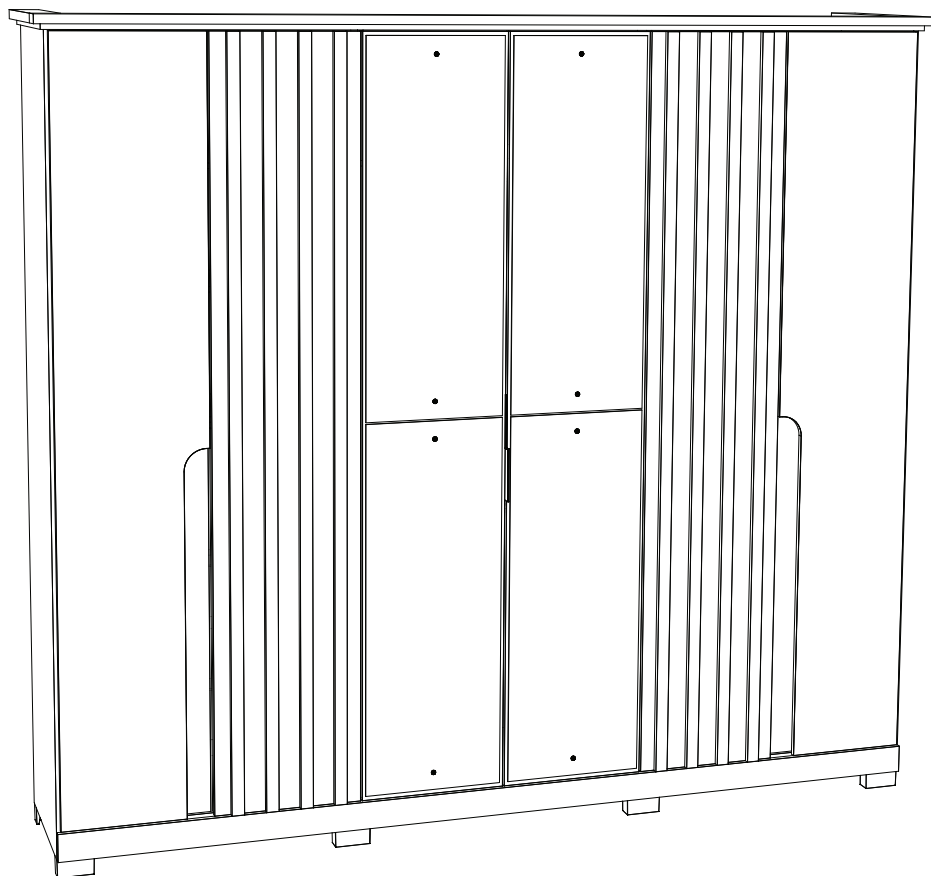

Agora que você já comprou o seu móvel, ele merece ser montado do jeito certo.

Erros de montagem causam mais de **60%** dos danos em móveis.

Por que contratar?

Tranquilidade do **início ao fim** da montagem



PROFISSIONAIS QUALIFICADOS

Especialistas certificados na **MadeiraMadeira Serviços**.



FERRAMENTAS PROFISSIONAIS

que **protegem** seus móveis.



AGENDAMENTO EM 24 HORAS

escolha a data e o turno **ideais para** você.



GARANTIA DE 3 MESES

de cobertura **completa**.

Mais de 1 MILHÃO DE MONTAGENS
★ com avaliação 4.7 ★

Mariana S., São Paulo

"Chegaram no horário e montaram tudo rapidamente. Serviço incrível!"



Carlos R., Belo Horizonte

"Tentei montar sozinho e foi um desastre. Com a **MadeiraMadeira Serviços** ficou perfeito."



Ana P., Rio de Janeiro

"Agendamento ágil e **montagem pontual e perfeita**. Recomendo demais!"



Agende agora pelo QR Code

Madeira**Madeira** Serviços · Atendimento em todo o Brasil



Escaneie o QRCode