

RECOMENDAÇÕES

Uso interno. Não expor ao sol ou umidade.

Capacidade máxima suportada: 120Kg

MANUTENÇÃO E LIMPEZA

Limpar com pano macio umedecido em solução de água e sabão neutro e secar em seguida.

Não utilizar produtos químicos ou abrasivos.

rivatti
móveis • decoração • design



Conheça nosso catálogo de tendências
ou acesse: www.rivatti.com.br

MANUAL DE INSTRUÇÕES

BANQUETA BAIXA BETIM

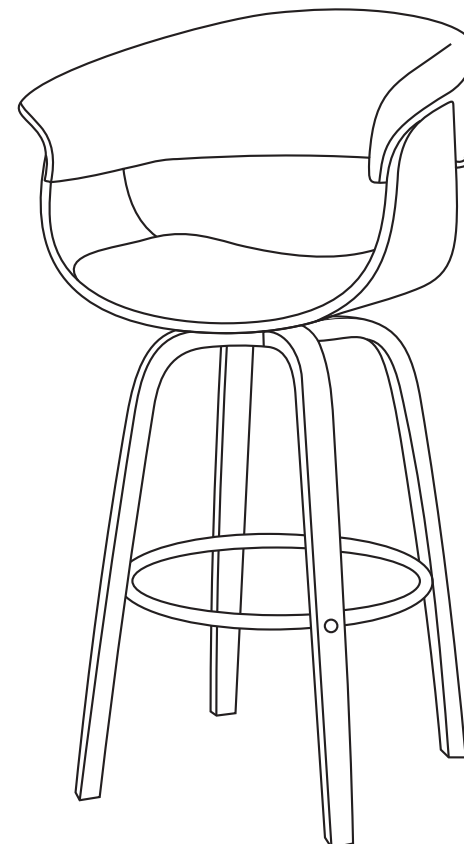

rivatti
móveis • decoração • design

COMPONENTES

(A) 1 UNID.

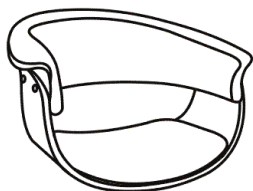

(F) 8 UNID.

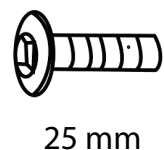

(B) 4 UNID.



(G) 4 UNID.

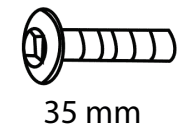

(C) 1 UNID.

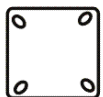

(H) 4 UNID.

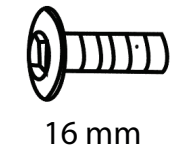

(D) 1 UNID.

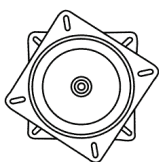

(I) 4 UNID.



(E) 1 UNID.

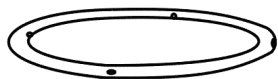

(J) 4 UNID.



INSTRUÇÕES DE MONTAGEM

1

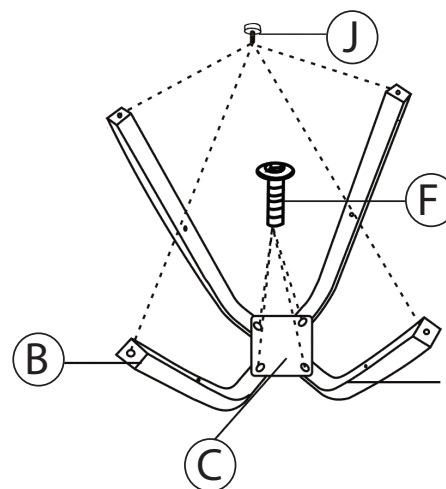

2

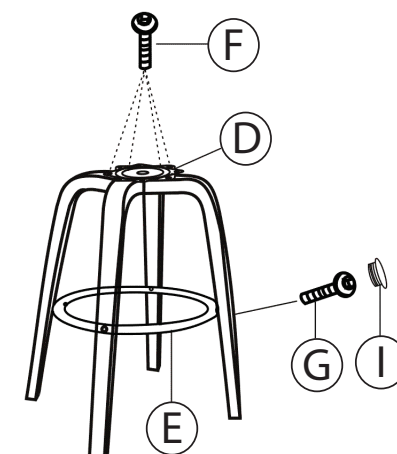

3

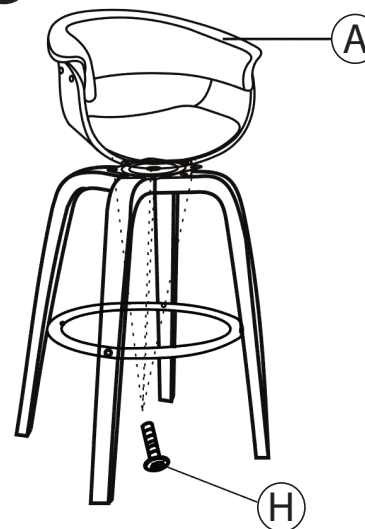

4

