

# HT180

DATA/FECHA/DATA:26/03/2022  
REVISÃO/REVISIÓN/REVISION:02

## INSTRUÇÕES DE MONTAGEM INSTRUCCIONES DE MONTAJE ASSEMBLY'S INSTRUCTIONS

 @prodecormoveis







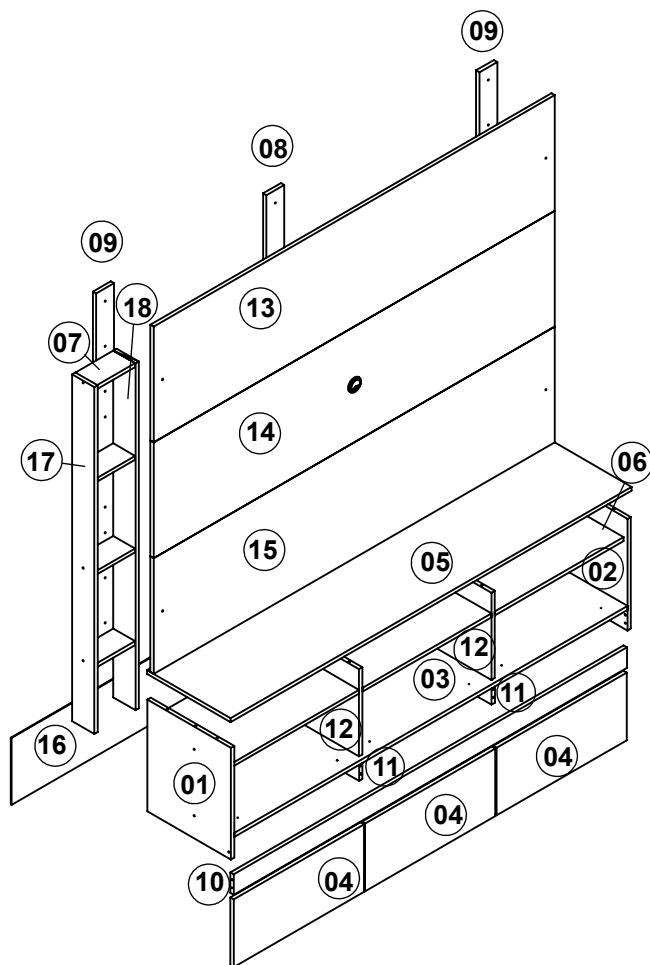





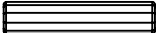
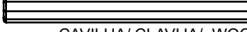

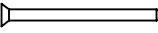

Rua: José Sachet / 213 A / Bairro São Francisco  
Farroupilha / RS / 95171-018 / Fone:(54) 3261-1165

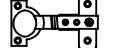
HOME 180 COM NICHO - 1800X1800X376  
HOME 180 CON NICHO - 1800X1800X376  
HOME 180 WITH NICHE - 1800X1800X376

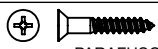

### LISTA DE PEÇAS / LISTA DE PIEZAS / FURNITURE PIECES LIST

COD	DESCRIÇÃO/DESCRIPCIÓN/DESCRIPTION	DIMENSÃO/DIM/DIM	QTD
01	LATERAL ESQUERDA/ LATERAL IZQUIERDO/ LEFT SIDE	434X375X15	01
02	LATERAL DIREITA/ LATERAL DERECHO/ RIGHT SIDE	434X375X15	01
03	BASE/ BASE/ BASE	1765X375X15	01
04	PORTA/ PUERTA/ DOOR	584X263X15	03
05	TAMPO/ TAPA/ TOP	1800X375X15	01
06	PRATELEIRA/ ESTANTE/ SHELF	578X357X15	03
07	PRATELEIRA/ ESTANTE/ SHELF	170X98X15	04
08	TRAVESSA CENTRAL/ TRAVESAÑO CENTRAL/ CROSSPIECE	1350X80X15	01
09	TRAVESSA/ TRAVESAÑO/ CROSSPIECE	1350X80X15	02
10	RODAPÉ/ RODAPIÉ/ FOOTER	1765X80X15	01
11	RODAPÉ MENOR/ RODAPIÉ MENOR/ SMALL FOOTER	357X80X15	02
12	DIVISÓRIA/DIVISIÓN/ PARTITION	339X357X15	02
13	PAINEL SUPERIOR/ PANEL SUPERIOR/ UPPER PANEL	1800X450X15	01
14	PAINEL CENTRAL/ PANEL CENTRAL/ CENTRAL PANEL	1800X450X15	01
15	PAINEL INFERIOR/PANEL INFERIOR/ LOWER PANEL	1800X450X15	01
16	COSTA/ FONDO/ BACK	1794X260X3	01
17	LATERAL ESQUERDA NICHO/ LATERAL IZQUIERDA/ LEFT SIDE	1348X100X15	01
18	LATERAL DIREITA NICHO/ LATERAL DERECHO/ RIGHT SIDE	1348X100X15	01

REF	DESCRIÇÃO	QTD
A	 CAVILHA/ CLAVIJA/ WOOD DOWEL 6x30MM	42
B	 CAVILHA/ CLAVIJA/ WOOD DOWEL 6x50MM	04
C	 PARAFUSO/ TORNILLO/ SCREW 3,5x40 CC	26
D	 ADESIVO TAPAFURO / ADHESIVO/ STICKER 15MM	16
E	 PREGO/ CLAVO/ NAIL 10X10	48
F	 ADESIVO PRO. DECOR/ ADHESIVO PRO. DECOR/ ADHESIVE PRO. DECOR	01
G	 PARAFUSO/ TORNILLO/ SCREW 3,5x14 CC	36
H	 CANTONEIRA/ ESQUINERO/ CORNER	06
I	 DOBRADIÇA/ BISAGRA/ HINGE (CANECO 26 CALÇO 12)	06
J	 COLA/ PEGAMENTO/ GLUE	01
K	 PARAFUSO/ TORNILLO/ SCREW 4x25 CC	18
L	 BUCHA PLÁSTICA / CASQUILLO / BUSHING 8MM	04
M	 PASSA FIOS/ PASA HILO/ THREAD 46MM	01
N	 PARAFUSO/ TORNILLO/ SCREW 5X60 CC	04
O	 PARAFUSO MINIFIX/ TORNILLO MINIFIX/ MINIFIX SCREW	04
P	 TAMBOR MINIFIX/ TORNILLO MINIFIX/ MINIFIX DRUM 12MM	04
Q	 SAPATA DESLIZADORA/ ZAPATO/ SHOE	10

IMPORTANTE LER COM ATENÇÃO E GUARDAR PARA EVENTUAIS CONSULTAS.  
IMPORTANTE LEER CON ATENCIÓN Y GUARDAR PARA EVENTUALES CONSULTAS.  
IMPORTANT TO READ CAREFULLY AND SAVE FOR ANY QUERIES.

FERRAMENTAS NECESSÁRIAS:  
HERRAMIENTAS NECESARIAS:  
NECESSARY TOOLS:



# Instruções de Montagem

Instrucciones de Montaje  
Assembly's Instructions



## RECOMENDAÇÕES:

**01** - Examine completamente todas as peças do móvel antes de iniciar o trabalho.

**02** - Recomenda-se montar o móvel conforme este Manual de Montagem.

**03** - É de responsabilidade do montador seguir as instruções do Manual de Montagem, que são fundamentais para garantir a estrutura do móvel.

**04** - Certifique-se de que todos os acessórios utilizados na montagem (parafusos, porcas, ponteiros) estejam fixados o suficiente, totalmente atarraxados, evitando que venham a provocar ferimentos.

## LIMPEZA:

**01** - Pano levemente umedecido com água, seguido de pano seco.

**02** - Não utilizar produtos químicos ou abrasivos.

## GARANTIA:

**01** - 3 meses para defeitos ou vícios de origem.

## ADVERTÊNCIAS:

**01** - Esteja ciente do risco de chama aberta e outras fontes de calor, tais como aquecedores elétricos, aquecedores a gás etc. nas proximidades do produto.

**02** - Não utilize o produto se alguma parte estiver quebrada, rasgada ou faltando. Utilizar somente peças de reposição aprovadas pelo fabricante.

## RECOMENDACIONES:

**01** - Examine completamente todas las piezas del mueble antes de empezar el montaje.

**02** - Recomienda-se montar el mueble de acuerdo con este Manual de Montaje.

**03** - Es de responsabilidad del montador seguir las instrucciones del Manual de Montaje, que son fundamentales para asegurar la estructura del mueble.

**04** - Asegure-se de que todos los accesorios utilizados en el montaje (tornillos, tuercas, ponteras) estén fijados el suficiente, totalmente roscados, evitando que vengan a provocar lesiones.

## LIMPIEZA:

**01** - Paño levemente humedecido con agua, siguiendo de paño seco.

**02** - No utilizar productos químicos o abrasivos.

## GARANTÍA:

**01** - 3 meses para defectos o vicios de origen.

## ADVERTENCIAS:

**01** - Tenga en cuenta el riesgo de llama abierta y otras fuentes de calor, tales como calentadores eléctricos, calentadores de gas, etc. en las proximidades del producto.

**02** - No utilice el producto si alguna parte esté rota, o perdida. Utilizar sólo piezas de repuesto aprobadas por el fabricante.

## RECOMMENDATIONS:

**01** - Check completely all the furniture's pieces before start to assemble it.

**02** - It is recommended to assemble this furniture according to this Assembly's Manual.

**03** - It is the assembler's responsibility to follow the instructions of this Assembly's Manual, which are essential to ensure the furniture's structure.

**04** - Ensure that all the accessories used in the assembly (bolts, nuts, tips) are well and enoughly fixed, completely threaded, avoiding injuries from happening.

## CLEANSING:

**01** - Cloth slightly moistened with water.

**02** - Do not use chemicals or abrasives products.

## WARRANTY:

**01** - 3 months due to manufacture defects.

## WARNINGS:

**01** - Be aware of the risk of open flame and other sources of heat, such as electric heaters, gas heaters etc. around the product.

**02** - Do not use the product if any part is broken, torn or missing. Only use replacement parts approved by the manufacturer.



# HT180

## INSTRUÇÃO DE MONTAGEM INSTRUCCIONES DE MONTAJE ASSEMBLY'S INSTRUCTIONS

pro.  
decor  
MÓVEIS

