

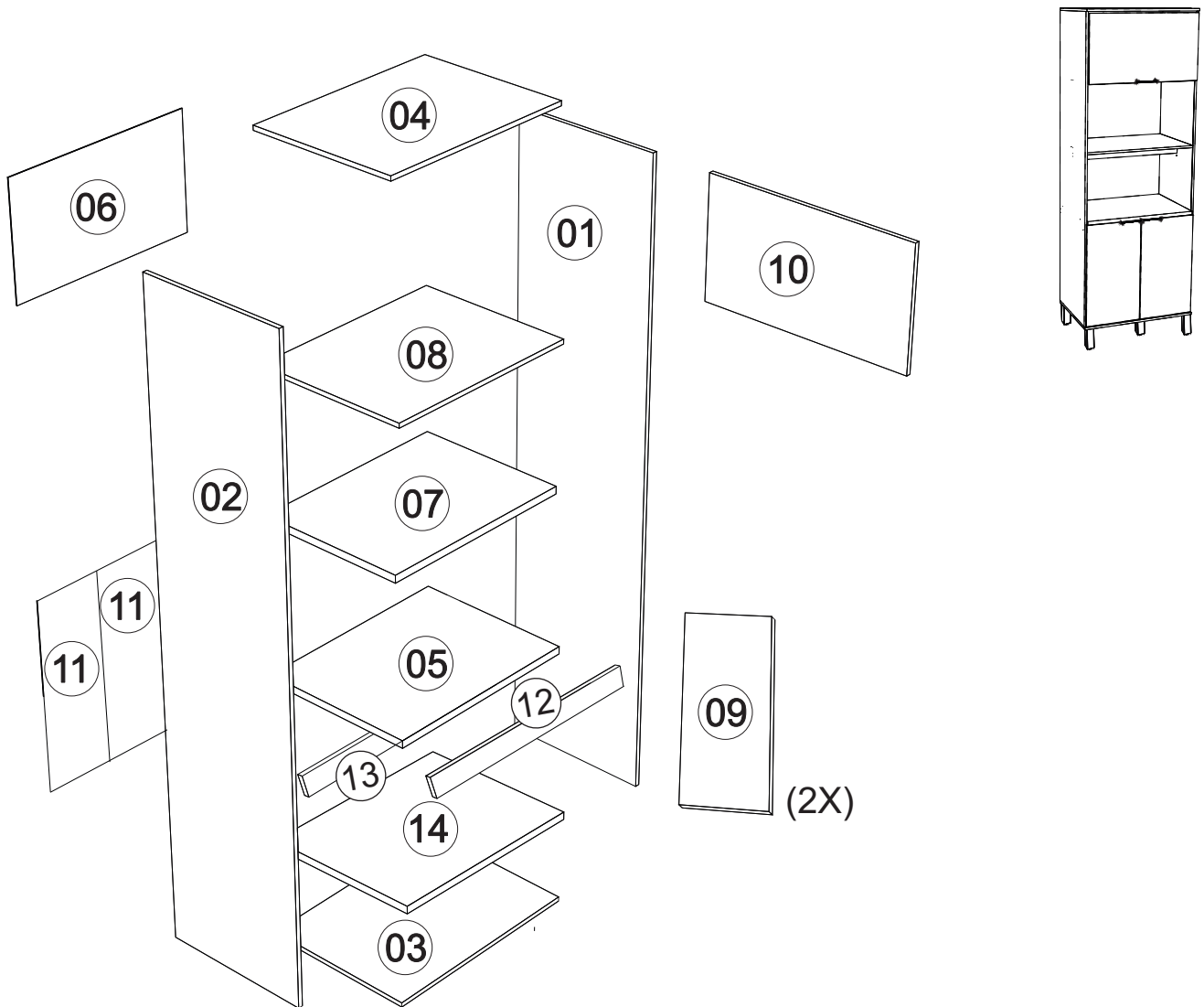

Rodovia SC-492 - Km 10 - B. Industrial  
89905-000 - Bandeirante - SC  
Fone: (49) 3622-4549  
e-mail: mxmoveis@mxmoveis.com.br

**Ref. TTO01**



**Torre quente 2 fornos**  
**Cozinha/Cocina**  
**TOSCANA**

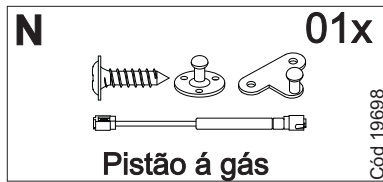
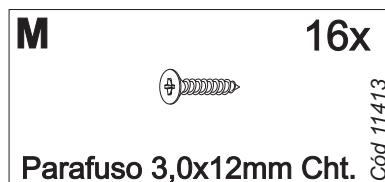
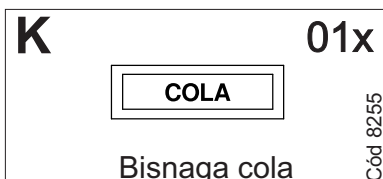
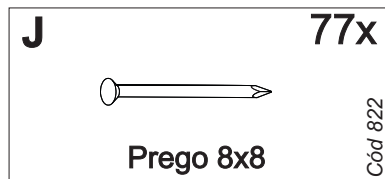
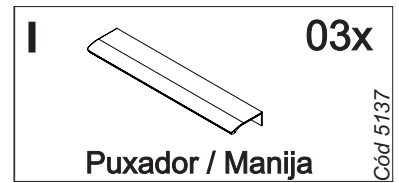
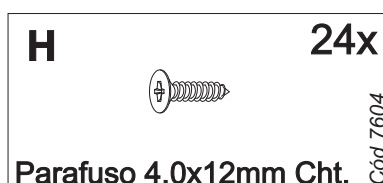
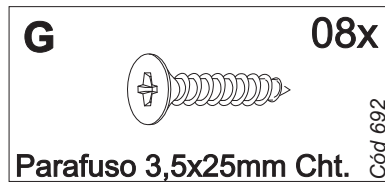
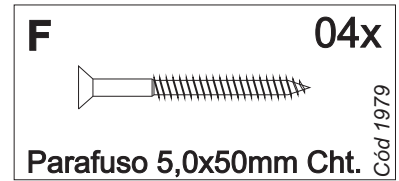
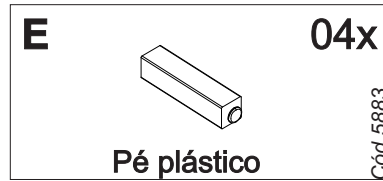
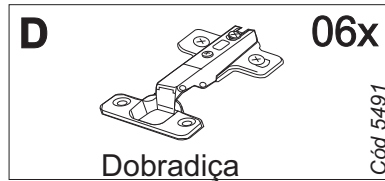
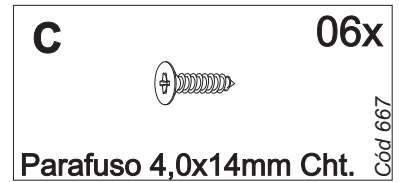
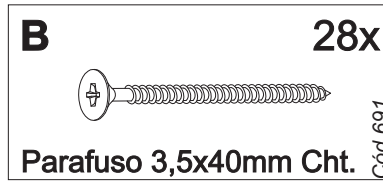

Nº	CÓDIGO ASSISTÊNCIA	NOME DA PEÇA/DESCRIPCIÓN PIEZAS	MEDIDAS (mm)	QTD.	CÓDIGO DAS PEÇAS/ CÓDIGO PIEZAS		
					FREIJÓ/FREIJÓ	FREIJÓ/NERO	FREIJÓ/JADE
01	TTO01.17.00	Lateral externa direita/Lateral derecha	2100x496x15	01	209289	209289	209289
02	TTO01.18.00	Lateral externa esquerda/Lateral izquierda	2100x496x15	01	209290	209290	209290
03	TTO01.01.02	Base inferior/Base inferior	800x516x15	01	209298	209298	209298
04	TTO01.05.01	Base superior/Base	800x516x15	01	209299	209299	209299
05	TTO01.33.01	Tampo/Tapa	770x516x22	01	209300	209300	209300
06	TTO01.13.01	Forro/Revés	784x464x2.5	01	209297	209297	209297
07	TTO01.02.02	Base micro/Base	770x496x22	01	210488	210488	210488
08	TTO01.01.01	Base inferior aéreo/Base inferior	770x496x15	01	209294	209294	209294
09	TTO01.25.00	Porta balcão/Puerta	702x389x15	01	209329	209332	209281
10	TTO01.25.01	Porta aéreo torre/Puerta	778x450x15	02	209282	209282	209282
11	TTO01.13.00	Forro/Revés	674x392x2.5	02	209296	209296	209296
12	TTO01.28.00	Ripa sustentação	770x50x15	01	210487	210487	210487
13	TTO01.28.01	Ripa sustentação	770x50x15	01	209293	209293	209293
14	TTO01.02.00	Base interna	770x496x15	01	209291	209291	209291

# Ferragens/Herrajes



 \*Usar os parafusos (G) para unir este módulo a outro. Usar los tornillos (G) para unirse este módulo a otro. 

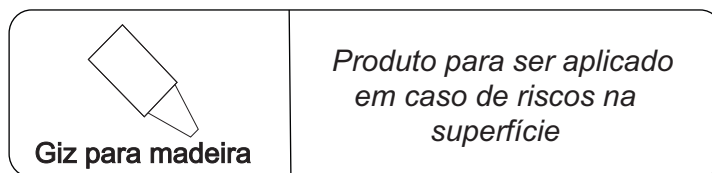
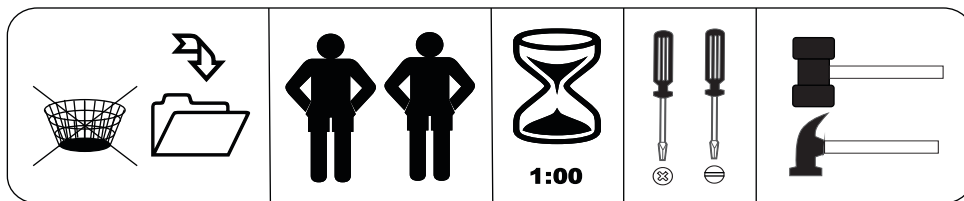

**Limpeza/Limpieza**

- ⚠ Use um pano levemente umedecido com água, seguido de pano seco.
- ⚠ Use solamente un paño húmedo con agua y después un paño seco.
- ⚠ Nunca utilize produtos químicos ou abrasivos.
- ⚠ No utilice productos químicos o abrasivos.

## Pré-Montagem/Preparación Piezas



Utilizar  
cola nas  
cavilhas.

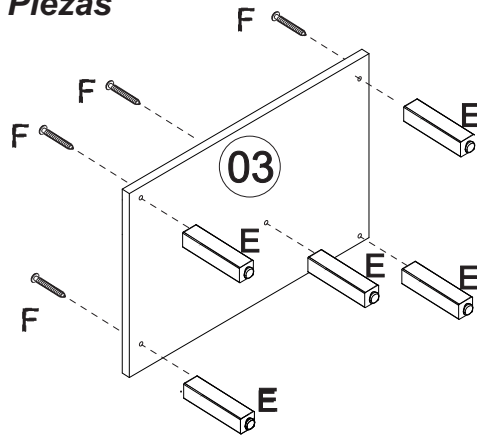

## 01 Montagem/Montaje

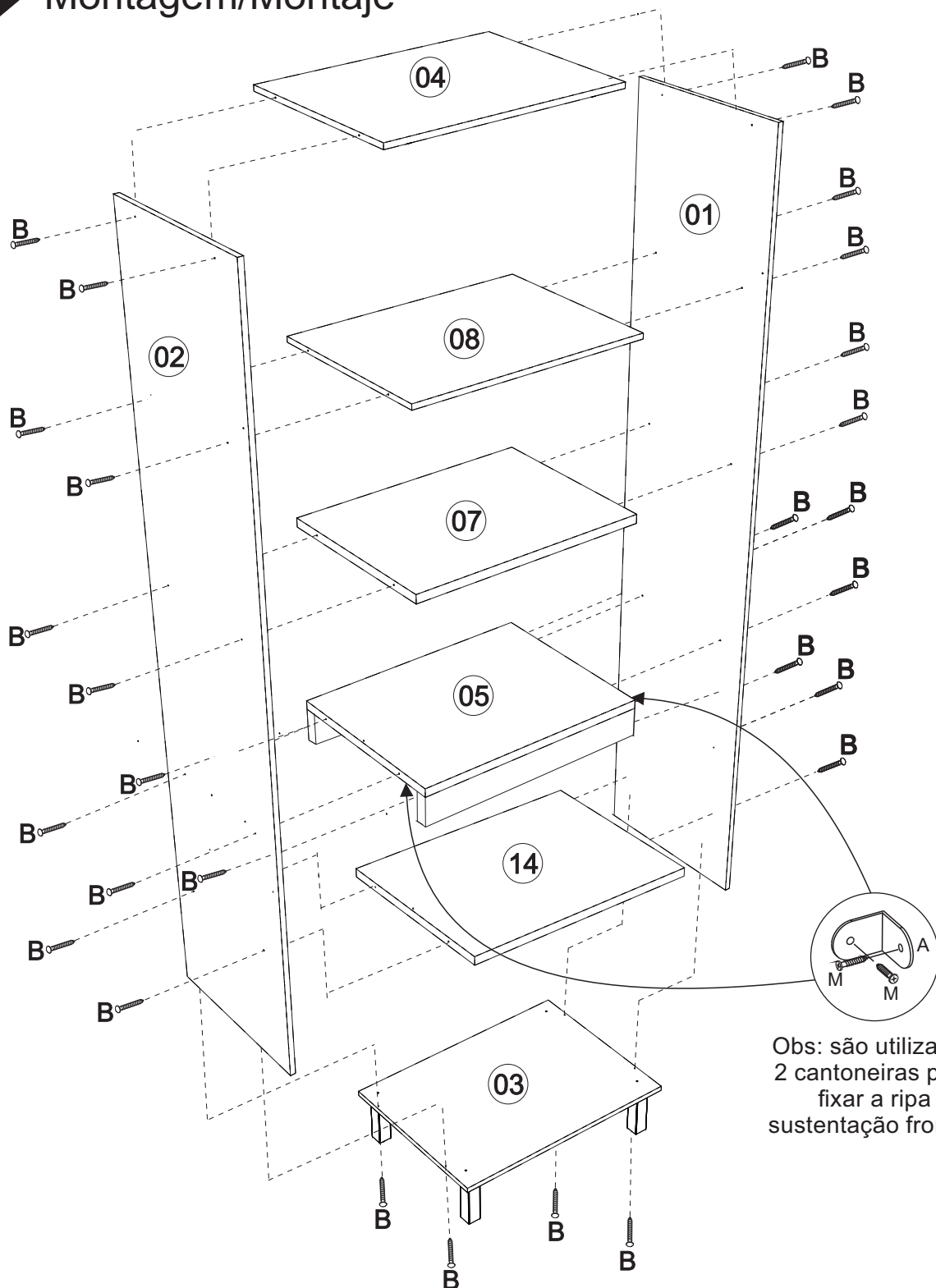

Obs: são utilizadas  
2 cantoneiras para  
fixar a ripa  
sustentação frontal.

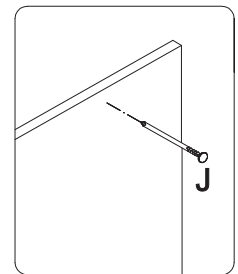
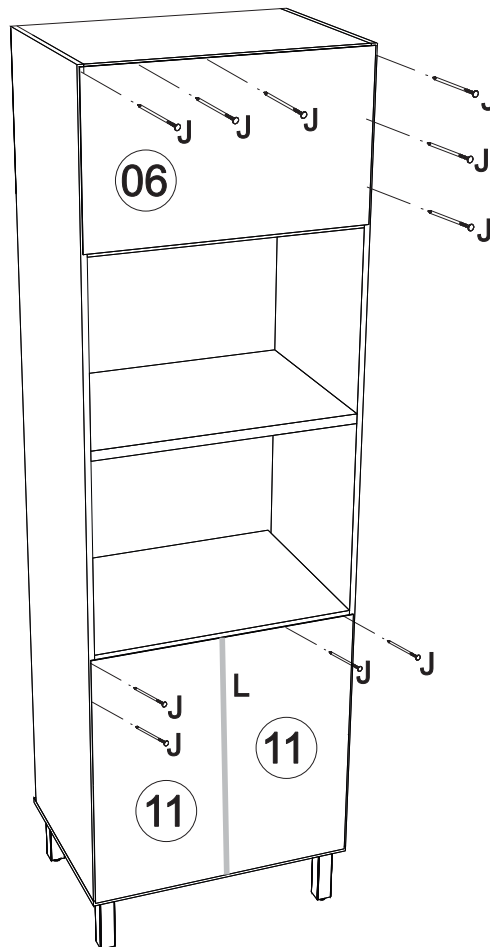
**02****Montagem/Montaje**

\*Colocar um prego (J) a cada 100mm

**03****Montagem/Montaje**