

CM-8021

Instruções de Montagem Assembly Instructions Instrucciones de Armado

Accesse Vídeos de Montagens
Access Mounting Videos
Acceder a los Vídeos de Montaje
www.tecnomobili.ind.br

tecnomobili

Estrada RSC 453, Km s/n° | Garibaldi | RS
CEP: 95720-000 | Fone / Fax: 54.3464.2050
sac@moveisvideira.com.br

Notas Especiais:

- 01** -Examine completamente todas as peças do móvel antes de começar o trabalho.
02 -Recomenda-se montar o móvel conforme este Manual de Montagem.
03 -É de responsabilidade do montador seguir as instruções do Manual de Montagem, que são fundamentais para garantir a estrutura do móvel.
04 -Para limpeza, utilizar somente pano úmido e sabão neutro.

Special notes:

- 01** -Check all parts of the unit thoroughly before starting work.
02 -It is recommended to assemble the furniture according to this Installation Manual.
03 -It is the responsibility of the assembler to follow the instructions in the Assembly Manual, which are essential to ensure the structure of the furniture.
04 -For cleaning use only damp cloth and neutral soap.

Notas especiales:

- 01** -Examine completamente todas las piezas del mueble antes de iniciar el trabajo.
02 -Se recomienda montar el mueble conforme el Manual de Ensamblaje.
03 -Es de responsabilidad del montador seguir las instrucciones del Manual de Ensamblaje, que son fundamentales para garantizar la estructura del mueble.
04 -Para limpieza solamente usar trapo húmedo y jabón neutro.

Guarante certificate:

The guarantee of products manufactured by Móveis Videira LTDA covers any defects / manufacturing defects, within the period established by the Consumer Protection Code, in its Article 26, II, which provides for a legal guarantee of ninety (90) days.

Lista de Peças / List of pieces / Lista de piezas

CÓD	DESCRIÇÃO	DESCRIPTION	DESCRIPCIÓN	QTD	M. PRIMA	DIMENSÕES	CÓD
01	Pé Dianteiro	Front Foot	Pié Diantero	1	MDP 15 mm	900x160x15 mm	328021
02	Pé Traseiro	Back Foot	Pié Trasero	1	MDP 15 mm	900x160x15 mm	348021
03	Prateleira Escada	Shelf Foot	Estante Escalera	2	MDP 15 mm	930x450x15 mm	208021
04	Travessa	Traverse	Traviesa	1	MDP 15 mm	450x45x15 mm	658021
05	Travessa Intermediaria Traseira	Rear intermediate Traverse	Traviesa intermediaria Trasera	1	MDP 15 mm	720x45x15 mm	618021
06	Lateral Inferior Gaveta	Drawer Lower Side	Lateral Inferior Cajón	1	MDP 15 mm	794x313x15 mm	308021
07	Travessa Superior Peseira	Headrest Upper Traverse	Traviesa Superior Pesera	1	MDP 15 mm	904x114x15 mm	608021
08	Rodapé	Baseboard	Rodapié	1	MDP 15 mm	450x78x15 mm	818021
09	Travessa Pega Gaveta	Drawer Platter Catches	Traviesa Pega Cajón	1	MDP 15 mm	435x45x15 mm	638021
10	Divisão Direita	Right Division	División Derecha	1	MDP 15 mm	785x933x15 mm	518021
11	Base	Base	Base	1	MDP 15 mm	910x434x15 mm	108021
12	Montante	Reinforcement	Refuerzo	1	MDP 15 mm	331x78x15 mm	668021
13	Prateleira	Shelf	Estante	1	MDP 15 mm	910x298x15 mm	218021
14	Rodapé Maior	Larger Baseboard	Rodapie Major	2	MDP 15 mm	910x78x15 mm	801021
15	Travessa Pega Maior	Larger Traverse Touch	Traviesa Touch Major	1	MDP 15 mm	910x45x15 mm	648021
16	Divisão Mesa	Table Division	División Mesa	1	MDP 15 mm	785x933x15 mm	528021
17	Costa	Back	Costa	2	MDP 03 mm	909x347x03 mm	408021
18	Costa Mesa	Table Back	Costa Mesa	1	MDP 15 mm	509x360x15 mm	438021
19	Frente	Front	Frente	1	MDP 15 mm	500x758x15 mm	78021
20	Base	Base	Base	1	MDP 15 mm	500x313x15 mm	104170
21	Prateleira	Shelf	Estante	1	MDP 15 mm	500x298x15 mm	204170
22	Travessa	Traverse	Traviesa	1	MDP 15 mm	297x98x15 mm	604170
23	Lateral Menor	Smaller Side	Lateral Menor	1	MDP 15 mm	676x500x15 mm	324170
24	Tampo	Top	Topa	1	MDP 15 mm	500x316x15 mm	714170
25	Tampo Mesa	Table Top	Tapa da Mesa	1	MDP 15 mm	600x500x15 mm	724170
26	Cabeceira	Headboard	Cabecera	1	MDP 15 mm	1170x940x15 mm	908021
27	Lateral	Side	Lateral	2	MDP 15 mm	1900x114x15 mm	318021
28	Lateral Proteção	Protection Side	Lateral Proteccion	1	MDP 15 mm	680x255x15 mm	338021
29	Suporte Para Lastro	Ballast Suport	Soporte Lastre	4	MDP 22 mm	900x40x22 mm	9697
30	Lastro	Ballast	Lastre	12	MDP 10 mm	900x50x10 mm	9655
31	Costa Gaveta	Drawer Back	Costa de Cajón	1	MDP 15 mm	410x125x15 mm	428021
32	Lateral Gaveta	Drawer Side	Lateral de Cajón	2	MDP 15 mm	298x125x15 mm	323607
33	Fundo Gaveta	Fotton Drawer	Fondo Cajón	1	MDP 03 mm	388x306x03 mm	418021
34	Frente Gaveta	Rigth Front	Frente Cajón	1	MDP 15 mm	444x208x15 mm	88021
35	Porta	Door	Puerta	2	MDP 15 mm	680x450x15 mm	98021











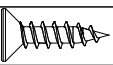
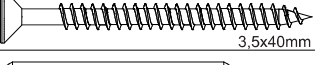
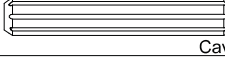
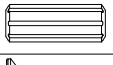
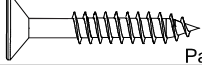
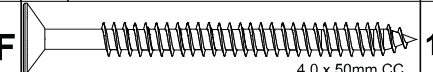



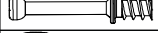

REF	DESCRIÇÃO	QTD	CÓD
A	 3,5x14mm CC	40	3639
B	 3,5x40mm CC	02	8115
C	 Cavilha 5 x 30mm	34	3880
D	 Cavilha 8 x 20mm	04	6521
E	 Parafuso 4x25 cc	10	9511
F	 4,0 x 50mm CC	18	9779

ILUSTRAÇÃO - ILUSTRACION - ILLUSTRATION

REF	DESCRIÇÃO	QTD	CÓD
G	 22x3mm Prego 10x10	56	3051
H	 13 x 13 x 3mm Fixador de Costa	05	6524
I	 14 x 4mm Sapata Deslizadora	13	8112
J	 Dobradiça Alta 26mm Calço Nº 12	04	6517
K	 Suporte Prateleira 8x10	02	
L	 9 x 12mm Porca Cilíndrica	08	9449
M	 34x7mm Parafuso minifix	46	3771
N	 15x12mm Tambor minifix	46	9516
O	 Adesivo Tapa Furo	28	
P	 Corrediça 350mm	01	
Q	 25,6 x 40mm Suporte para Lastro	08	
R	 Parafuso 3,5 x 14 CF	16	3639
S	 45x32x5mm Dobradiça Piano 4 Furos	02	3780
T	 Roldana 62x12x16mm	02	9767
U	 Rodizio RB 30	04	9768
V	 40 x 40 x 1mm Junção de Tampo	01	3766



Ferramentas | Tools | Herramientas

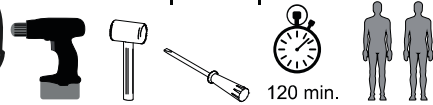

Revisão: 03
Data: 23/06/2023

Use the ruler below to measure the components

Measured in mm

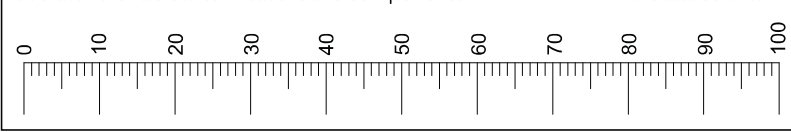

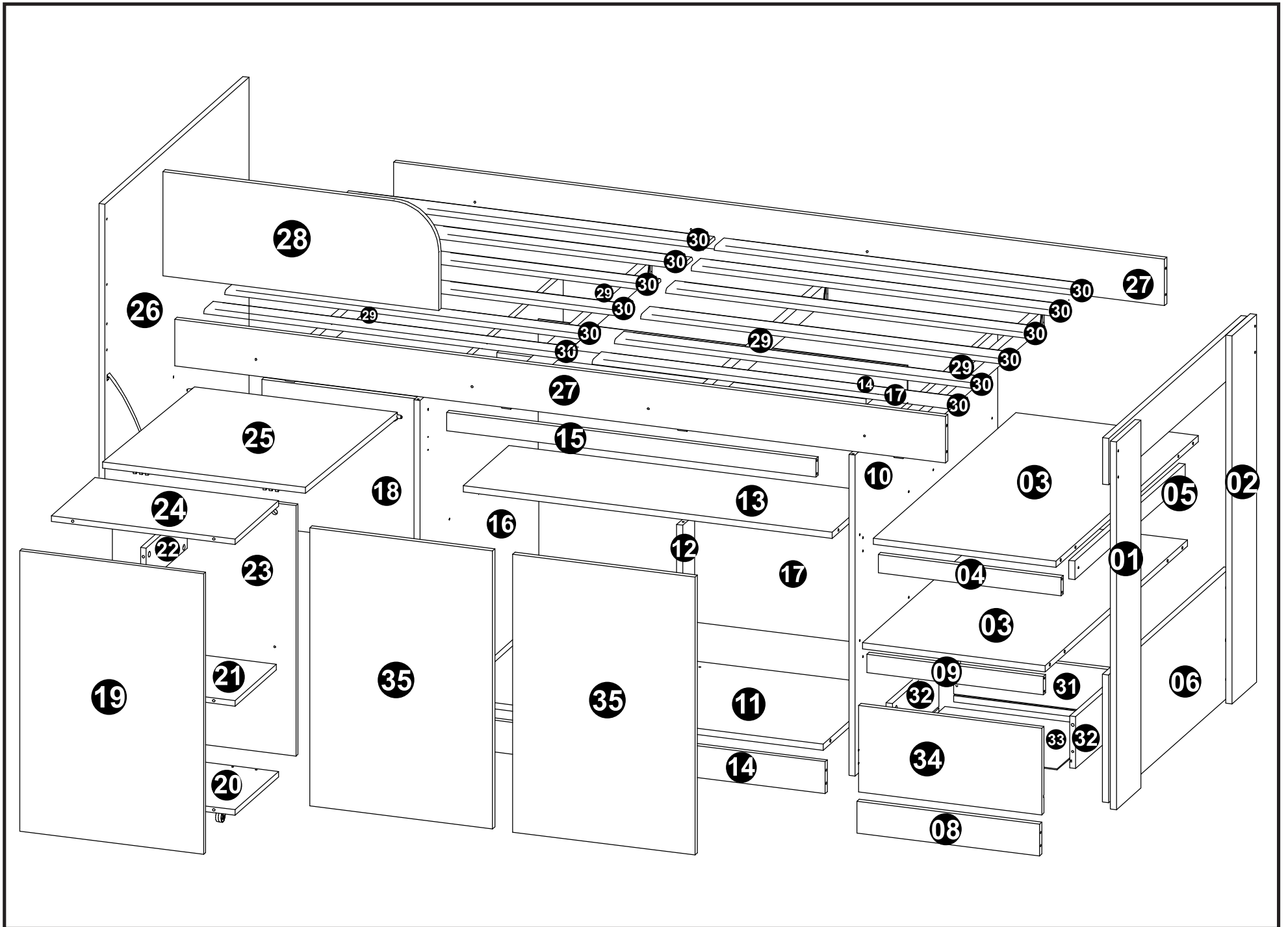

1

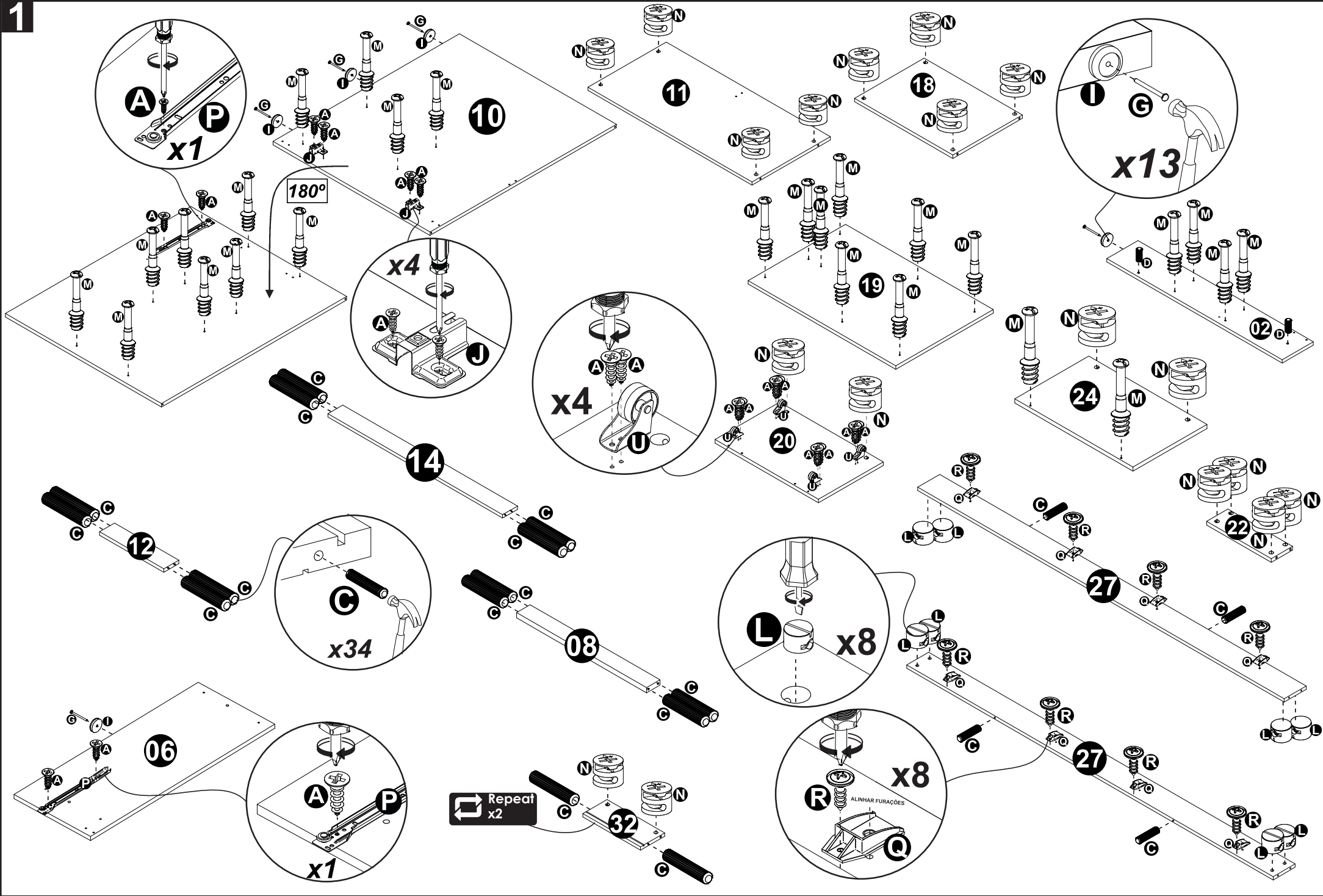

2

