

# BN-3614

## Instruções de Montagem Assembly Instructions Instrucciones de Armado

Acesse Vídeos de Montagens  
Access Mounting Videos  
Acceder a los Vídeos de Montaje  
[www.tecnomobili.ind.br](http://www.tecnomobili.ind.br)

**tecnomobili**

Estrada RSC 453, Km s/n° | Garibaldi | RS  
CEP: 95720-000 | Fone / Fax: 54.3464.2050

[sac@moveisvideira.com.br](mailto:sac@moveisvideira.com.br)

### Notas Especiais:

**01** -Examine completamente todas as peças do móvel antes de começar o trabalho.

**02** -Recomenda-se montar o móvel conforme este Manual de Montagem.

**03** -É de responsabilidade do montador seguir as instruções do Manual de Montagem, que são fundamentais para garantir a estrutura do móvel.

**04** -Para limpeza, utilizar somente pano úmido e sabão neutro.

### Special notes:

**01** -Check all parts of the unit thoroughly before starting work.

**02** -It is recommended to assemble the furniture according to this Installation Manual.

**03** -It is the responsibility of the assembler to follow the instructions in the Assembly Manual, which are essential to ensure the structure of the furniture.

**04** -For cleaning use only damp cloth and neutral soap.

### Notas especiales:

**01** -Examine completamente todas las piezas del mueble antes de iniciar el trabajo.

**02** -Se recomienda montar el mueble conforme el Manual de Ensamblaje.

**03** -Es de responsabilidad del montador seguir las instrucciones del Manual de Ensamblaje, que son fundamentales para garantizar la estructura del mueble.

**04** -Para limpieza solamente usar trapo húmedo y jabón neutro.

### Guarante certificate:



The guarantee of products manufactured by Móveis Videira LTDA covers any defects / manufacturing defects, within the period established by the Consumer Protection Code, in its Article 26, II, which provides for a legal guarantee of ninety (90) days.

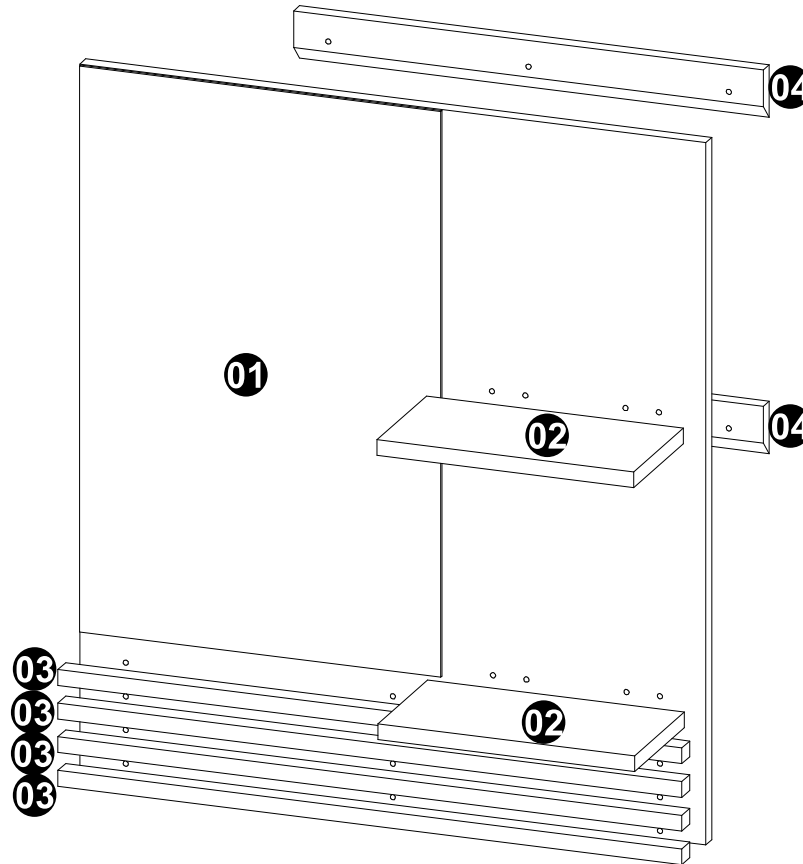

CóD	DESCRIÇÃO	DESCRIPTION	DESCRIPCION	QTD	RAW MATERIAL	DIMENSION	CÓD
01	Painel Espelho	Mirror Panel	Panel Espejo	1	MDP 15mm	668x600x15mm	903614
02	Prateleira	Shelf	Estante	2	MDP 15mm	246x126x15mm	203608
03	Aplik	Aplik	Aplik	4	MDP 15mm	598x20x15mm	853614
04	Suporte Painel	Panel Support	Soporte Panel	4	MDP 15mm	450x50x15mm	9795

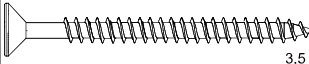
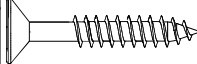
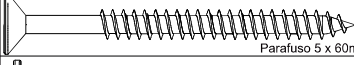

### TAMANHO REAL - TAMAÑO VERDADERO - REAL SIZE

REF	DESCRIÇÃO	QTD	CÓD
A	 Cavilha 5 x 30mm	04	3880
B	 3,5 x 40mm CC	04	8115
C	 Parafuso 4 x 25mm CC	06	9511
D	 Parafuso 5 x 60mm CC	04	1618
E	 Parafuso 3,5 x 30mm CF	12	5753

### ILUSTRAÇÃO - ILUSTRACION - ILLUSTRATION

REF	DESCRIÇÃO	QTD	CÓD
F	 40x8mm Buchas 8mm	04	5623

### Ferramentas | Tools | Herramientas

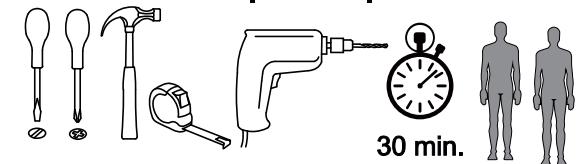

30 min.

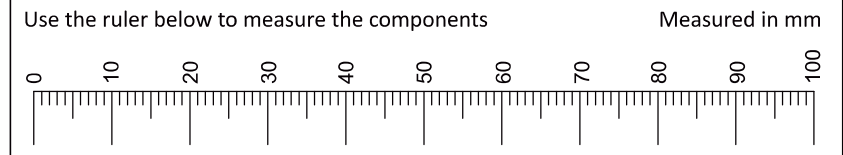

Revisão: 00  
Data: 10/11/2022

