

- Montagem da base do produto

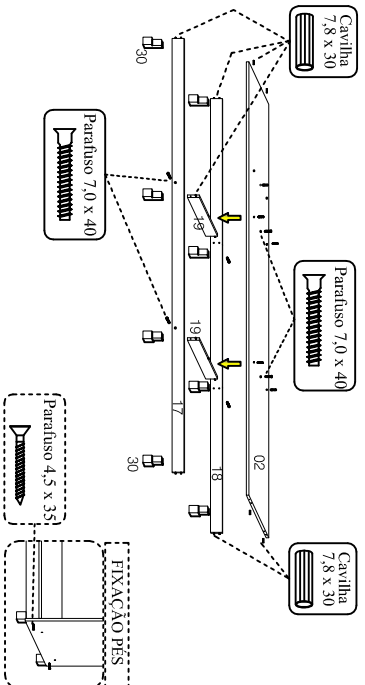

- Fixação do tampo superior e os suportes com as corredeiras na parte central

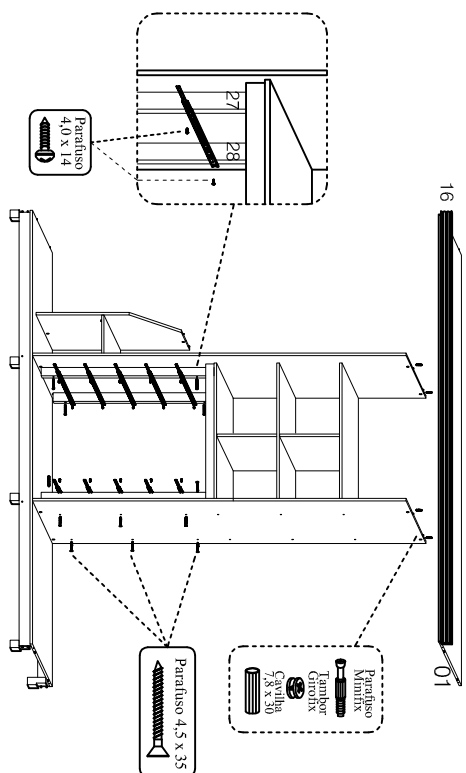

- Montagem das laterais e prateleiras da parte central

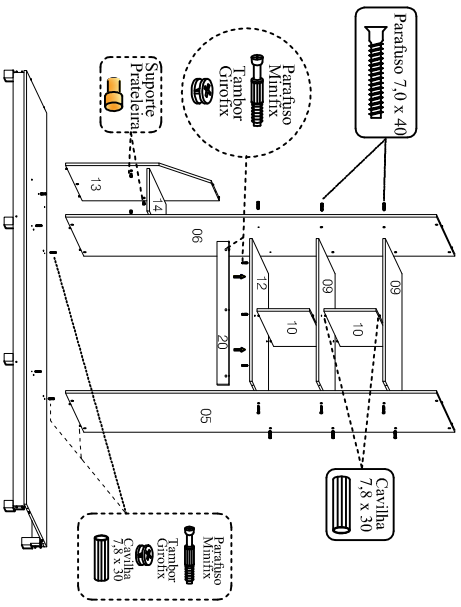

- Fixação das laterais externas, prateleiras do maleiro e tampo do calceiro

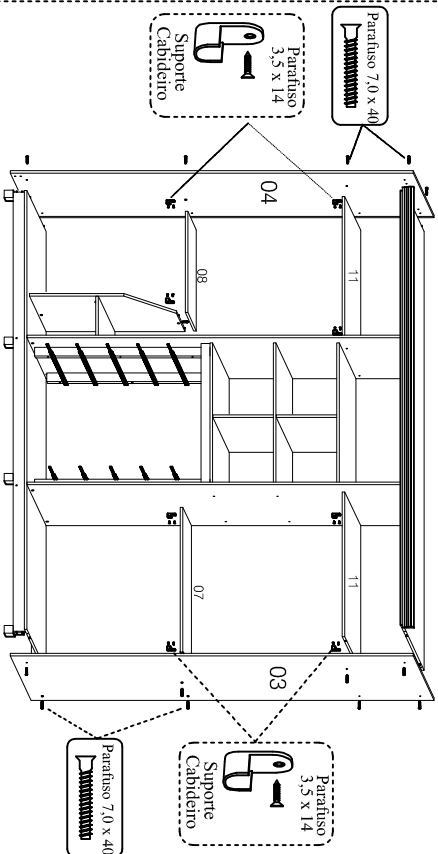

- Preparação do tampo superior

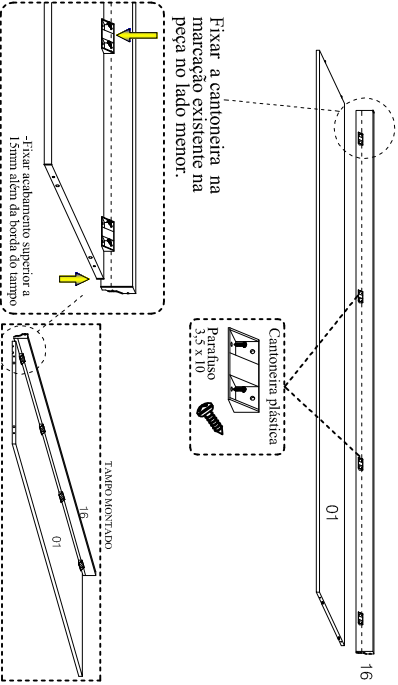

ESQUEMA DE MONTAGEM

Nº	REF.	PEÇAS	QT.
01	19136	Tampo superior	01
02	19135	Base inferior	01
03	19137	Lateral externa direita	01
04	19138	Lateral externa esquerda	01
05	19139	Lateral interna direita	01
06	19140	Lateral interna esquerda	01
07	19149	Tampo calceiro maior	01
08	19150	Tampo calceiro menor	01
09	19144	Prateleira colmeia	02
10	19152	Divisoria colmeia	02
11	19146	Prateleira maleiro	02
12	19844	Tampo gaveteiro	01
13	19151	Divisoria calceiro menor	01
14	19145	Prateleira inferior pequena	01
15	19163	Moldura da lateral	02
16	19164	Acabamento superior fresado	01
17	19141	Rodapé frontal	01
18	19142	Rodapé traseiro	01
19	19143	Trava central rodapé	02
20	19148	Trava reforço tampo gaveteiro	01
21	19160	Portas	04
22	19161	Fundo traseiro	03
23	19155	Frete gaveta	05
24	19156	Contra fundo gaveta	05
25	19157	Lateral gaveta	10
26	19846	Fundo gaveta	05
27	19158	Distanciador corredeira frontal	02
28	19159	Distanciador corredeira traseiro	02
29	10007	Reforço gaveta	03
30	19166	Pé Gr. c/ rebaxo	08
31	19367	Portas Espelho Reflecta	02

Fazgio
INDÚSTRIA DE MÓVEIS 4F LTDA
Rodovia Euclides da Cunha km 594,5
Urânia -SP Cep:15760-000
Fone: (17) 3634-3001
www.fazgio.com.br

Fixar a cantoneira na marcação existente na peça no lado menor.

-Fixar acabamento superior a 15mm além da borda do tampo

- Fixação das molduras nas laterais externas.

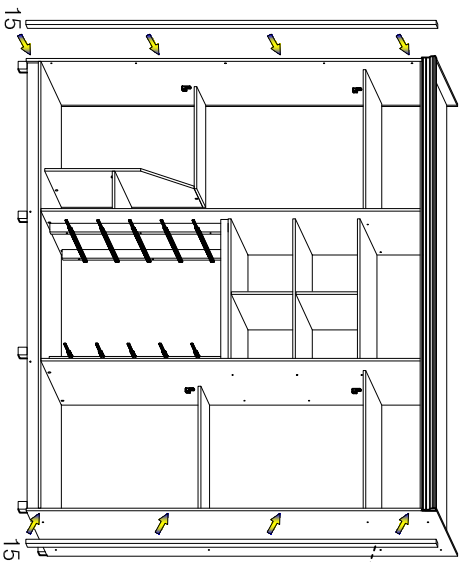

OBS: Detalhe da fixação da moldura na lateral.

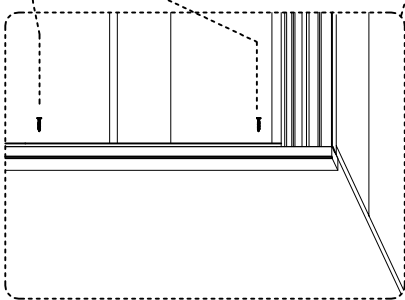

- Fixação do fundo traseiro.

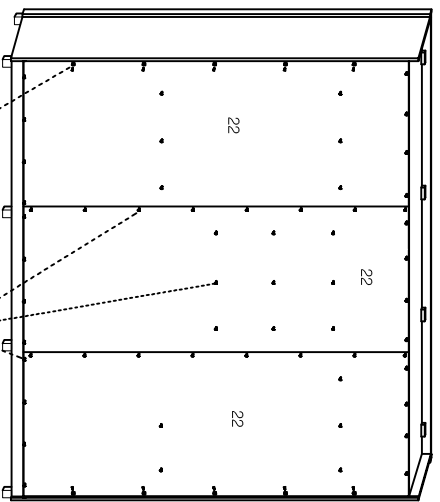

Cantoneira fixar fundos
Parafuso 3,5 x 14

Parafuso 3,5 x 12

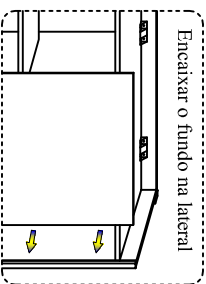

Encaixar o fundo na lateral

- Colocar o fundo central e fixá-lo junto aos outros na lateral interna, tampo e base.

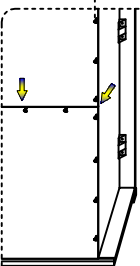

MONTAGEM DA GAVETA

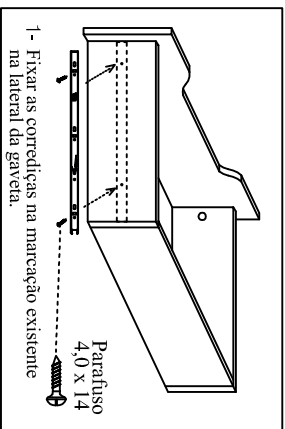
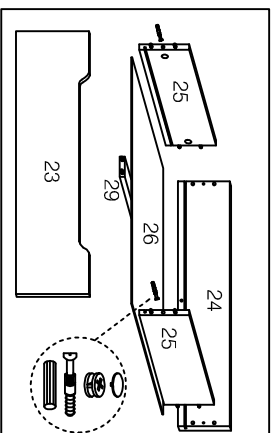

- Preparação das portas.

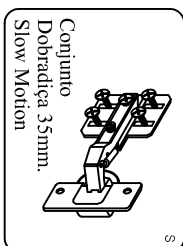



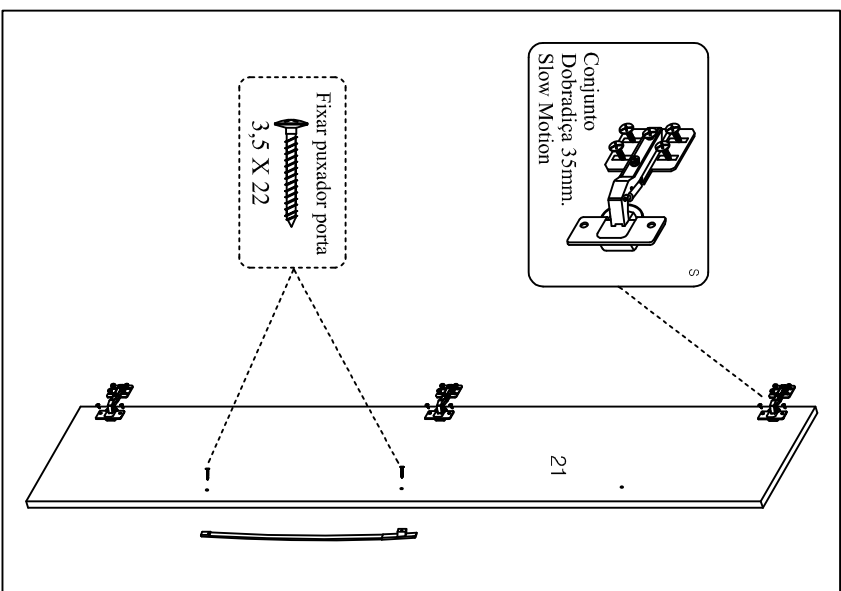



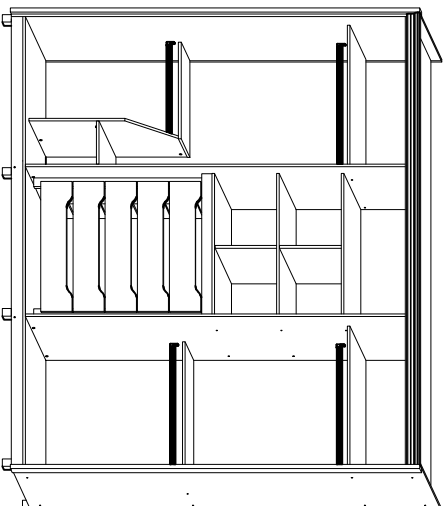





Fixar puxador porta
Parafuso 3,5 X 22



- Produto montado



FERRAGENS E ACESSÓRIOS	QT.
PARAFUSO 3,5 x 14 + 	26
FIXAR SUPORTE CABIDEIRO E FIXADOR FUNDOS PARAFUSO 3,5 x 22 FLANGEADO + 	12
FIXAR PUXADORES PARAFUSO 7 x 40 RETA PRETO + 	41
FIXAR PRATELEIRAS, TAMPO, BASE E LATERAIS TAMPA ADESIVA 	50
TAMBOR MINIFIX PINO MINIFIX 	32
PARAFUSO 3,5 x 30 + 	10
FIXAR MOLDURAS DA LATERAL PARAFUSO 4,5 x 35 + 	20
FIXAR PÉS GR. E DISTANCIADOR CORREDIÇA PARAFUSO 3,5 x 10 + 	16
FIXAR CANTONEIRA PLÁSTICA PARAFUSO 4,0 x 14 ZINCADO + 	108
FIXAR DOBRADIÇAS DAS PORTAS PARAFUSO 4,0 x 14 OXIDADO + 	32
FIXAR CORREDIÇAS DAS GAVETAS PARAFUSO 3,5 X 12 + 	90
FIXAR FUNDO TRASEIRO FIXADOR FUNDOS 	10
FIXAR FUNDO TRASEIRO NAS LATERAIS EXTERNAS PREGO 10 x 10 	08

GR. ORNATTO 6P

MONTAGEM FINAL

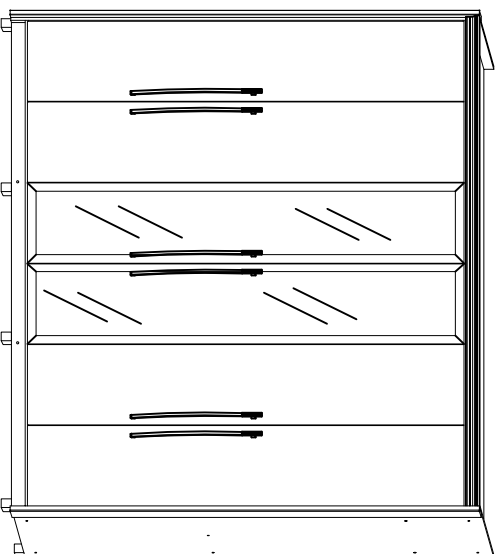





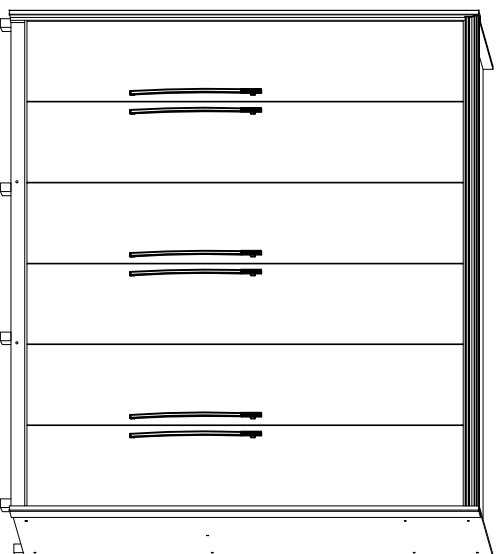

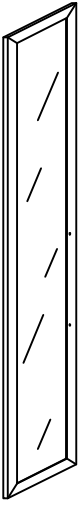

GR. MURANO PLUS 6P

MONTAGEM FINAL

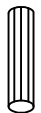
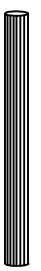

PORTA ESPELHO REFLECTA	02
	

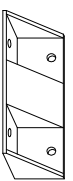
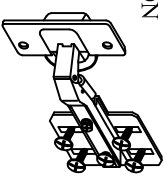
INDÚSTRIA DE MÓVEIS 4F LTDA
 Rodovia Euclides da Cunha km 594,5
 Urânia -SP Cep:15760-000
 Fone: (17) 3634-3001
 www.fazzio.com.br

FERRAGENS E ACESSÓRIOS	QT.
CORREDIÇA TELESCÓPICA 400mm - par 	04
SUPORTE CABIDEIRO 	08
CAVILHA 7,8 x 30 	106
TUBO CABIDEIRO 563mm 	01
TUBO CABIDEIRO 835mm 	03
SAPATA" L" 	08
SUPORTE PRATELEIRA 	04
CANTONEIRA PLÁSTICA 	04
DOBRADIÇAS SLOW MOTION 	18
FIXADOR FUNDOS FIXAR FUNDO TRASEIRO NAS LATERAIS EXTERNAS 	10
PUXADOR PORTA 	06