

BN-3610

Instruções de Montagem Assembly Instructions Instrucciones de Armado

Accesse Vídeos de Montagens
Access Mounting Videos
Acceder a los Vídeos de Montage
www.tecnomobili.ind.br

tecnomobili
Estrada RSC 453, Km s/n° | Garibaldi | RS
CEP: 95720-000 | Fone / Fax: 54.3464.2050
sac@moveisvideira.com.br

Notas Especiais:

- 01** -Examine completamente todas as peças do móvel antes de começar o trabalho.
02 -Recomenda-se montar o móvel conforme este Manual de Montagem.
03 -É de responsabilidade do montador seguir as instruções do Manual de Montagem, que são fundamentais para garantir a estrutura do móvel.
04 -Para limpeza, utilizar somente pano úmido e sabão neutro.

Special notes:

- 01** -Check all parts of the unit thoroughly before starting work.
02 -It is recommended to assemble the furniture according to this Installation Manual.
03 -It is the responsibility of the assembler to follow the instructions in the Assembly Manual, which are essential to ensure the structure of the furniture.
04 -For cleaning use only damp cloth and neutral soap.

Notas especiales:

- 01** -Examine completamente todas las piezas del mueble antes de iniciar el trabajo.
02 -Se recomienda montar el mueble conforme el Manual de Ensamblaje.
03 -Es de responsabilidad del montador seguir las instrucciones del Manual de Ensamblaje, que son fundamentales para garantizar la estructura del mueble.
04 -Para limpieza solamente usar trapo húmedo y jabón neutro.

Guarante certificate:

The guarantee of products manufactured by Móveis Videira LTDA covers any defects / manufacturing defects, within the period established by the Consumer Protection Code, in its Article 26, II, which provides for a legal guarantee of ninety (90) days.



Cód	DESCRIÇÃO	DESCRIPTION	DESCRIPCIÓN	QTD	RAW MATERIAL	DIMENSION	CÓD
01	Painel Espelho	Mirror Panel	Panel Espejo	1	MDP 15mm	600x540x15mm	903610
02	Prateleira Superior	Top Shelf	Estante Superior	1	MDP 15mm	596x126x15mm	203610
03	Suporte Painel	Panel Support	Soporte Panel	4	MDP 15mm	450x50x15mm	9797

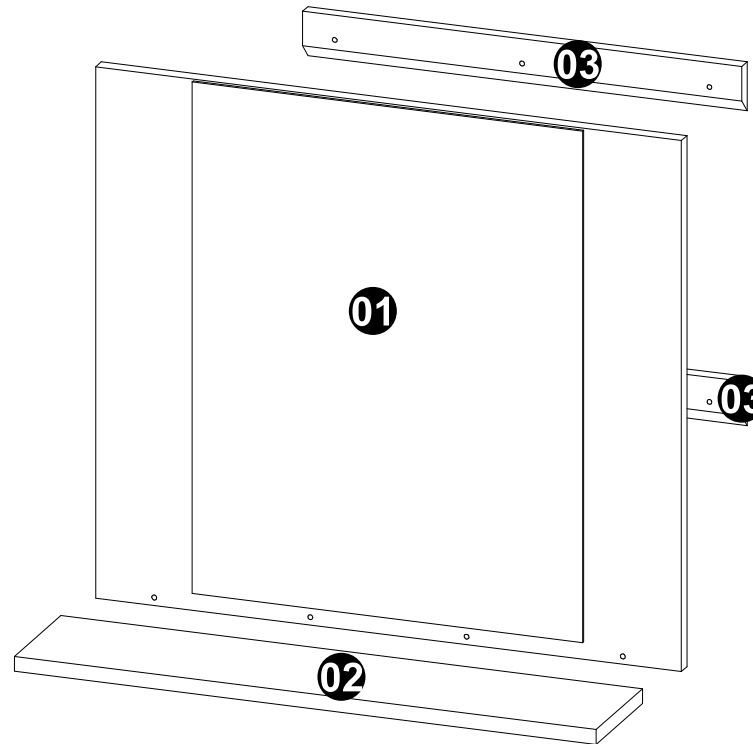

TAMANHO REAL - TAMAÑO VERDADERO - REAL SIZE





REF	DESCRIÇÃO	QTD	CÓD
A	 Parafuso 4 x 25mm CC	06	9511
B	 Parafuso 5 x 60mm CC	04	1618

ILUSTRAÇÃO - ILUSTRACION - ILLUSTRATION

REF	DESCRIÇÃO	QTD	CÓD
C	 40x8mm Buchta 8mm	04	5623
D	 9 x 12mm Porca Cilíndrica	04	9449
E	 Parafuso 4,0x50mm CF	04	2070
F	 Tapa Furo	04	

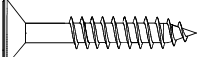
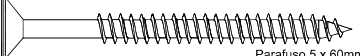
Ferramentas | Tools | Herramientas

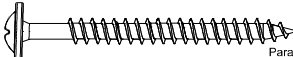

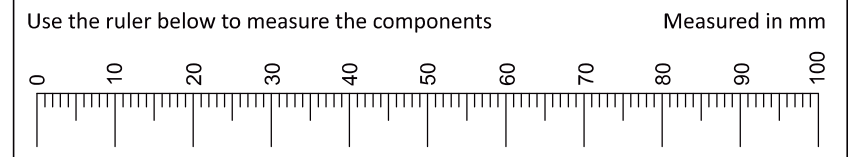
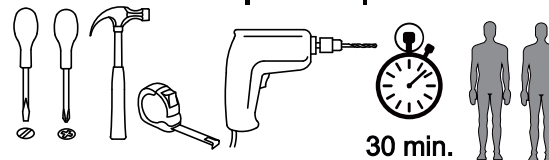
Revisão: 03
Data: 21/06/2023

