

MESA ESCRIVANINHA / DESKTOP TABLE

FITMOBEL

# TOKYO 900/1200

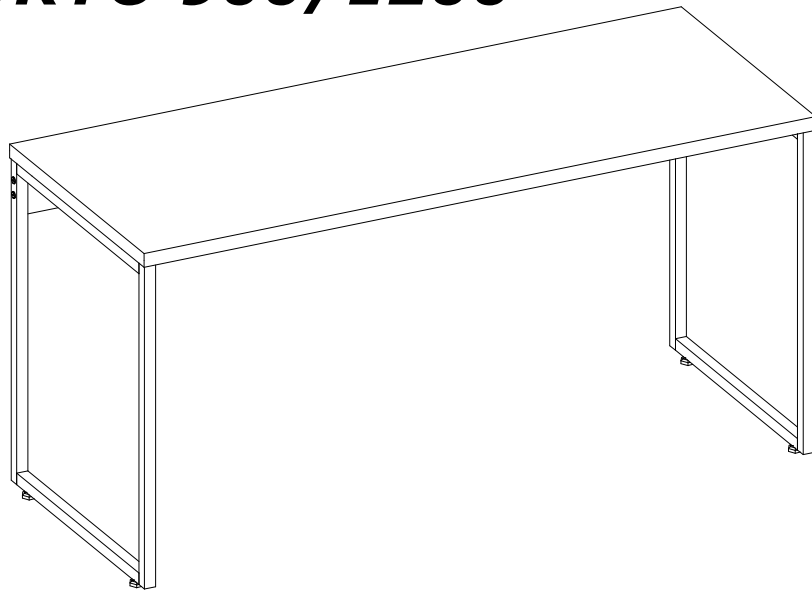

**Parabéns** pela aquisição de um produto de qualidade.  
Em caso de dúvidas procure a loja em que efetuou a compra.  
**Congratulations** on your purchase of a product of quality.  
When in doubt look for the shop where you made the purchase.  
**Enhorabuena** por la compra de un producto de calidad.  
En caso de duda buscar la tienda donde hizo la compra.

**Montador**  
Observe atentamente as instruções e siga rigorosamente as etapas de montagem.  
Após a montagem entregue ao cliente para a garantia do produto  
**Assembler**  
Note the instructions carefully and strictly follow the assembly steps.  
After assembly delivered to the customer for the product warranty  
**Ensamblador**  
tenga en cuenta las instrucciones cuidadosamente y seguir estrictamente los pasos de montaje.  
Después del montaje entregado al cliente para la garantía del producto

**Observações:**  
-Para limpeza somente com pano seco, não utilize álcool ou produtos químicos tipo limpeza pesada, bem como produtos abrasivos.  
-Pouca resistência à umidade.  
- 3 meses de garantia legal contra eventuais defeitos de fabricação .  
Não é coberto pela garantia. Danos referentes ao uso do produtos.  
**Resistência**  
-40KG.

**Comments:**  
-For cleaning use only cloth slightly moistened with water with neutral detergent.  
Do not use alcohol or heavy-duty cleaning chemicals as well as abrasive products.  
-Low resistance to humidity







**Warranty**  
- 3 months of legal warranty against any manufacturing defects.  
It is not covered by warranty . Damages for the use of the product .  
**Resistance**  
-40kg

**Observaciones:**  
-Para La limpieza utilice sólo ligeramente humedecido en agua con un detergente suave.  
No utilice alcohol ni productos químicos como la limpieza pesada y productos abrasivos  
-Poca resistencia a la humedad lo hará  
**Garantía**  
- 3 meses de garantía legal contra cualquier defecto de fabricación .  
No está cubierto por la garantía . Los daños para el uso del producto.  
**Resistencia**  
-40kg

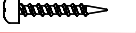

Manual do Produto/Product Manual/Manual del Product

## Montagem / Assembly / Montaje

Acessórios / Accessories / Accesorios

<b>A</b> Parafuso PA PH SB 5,0x30 Screw Tornillo 04 	<b>B</b> Sapata Shoes Zapata 04 	<b>C</b> Bucha sapata Shoe bushing Buje de zapata 04 
<b>D</b> Parafuso AL INT SB 7,0x60 Screw Tornillo 04 	<b>E</b> Parafuso PA PH SB 4,0x14 Screw Tornillo 04 	<b>F</b> Chave allen 4,0 Allen key llave allen 01 
<b>G</b> Cantoneira Corner Cantón 01 		

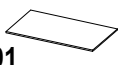
Peças / Parts / Partes

<b>01</b> Tampo Top Tapa 	<b>02</b> Painel frontal Frontal View 	<b>03</b> Pé Foot Pie 
---	---	--

### Instrução / Instruction / Instrucciones

Antes de montar, confira todos os componentes e acessórios de acordo com a lista.  
Forre o chão com papelão ou tecido.  
Evite batidas nas peças ou entre elas para evitar riscos ou danos às estruturas.

Before mounting , check all components and accessories according to the list .  
Paper or cardboard with the ground fabric.  
Avoid tapping on the parts or between them to avoid scratches or damage to structures .

Antes del montaje , compruebe todos los componentes y accesorios de acuerdo a la lista.  
Papel o cartón con el tejido de fondo .  
Evitar tocar en las partes o entre ellos para evitar arañazos o daños a las estructuras .

Ferramentas / Tools / Herramientas



1<sup>a</sup>

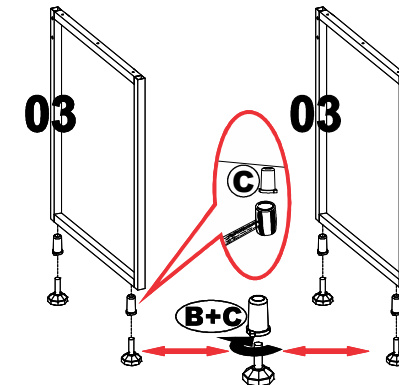

2<sup>a</sup>

Utilizar a Chave Allen para fixação dos Parafusos no Pé ao painel  
Use Allen wrench to secure Screws on Feet to panel with shoe  
Utilizar la llave Allen para fijar los Tornillos en el Pies al panelbucha zapato

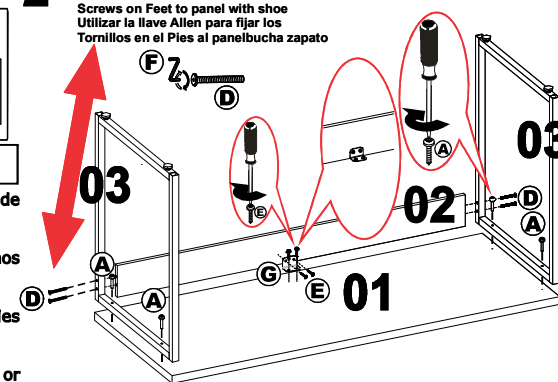

3<sup>a</sup>

