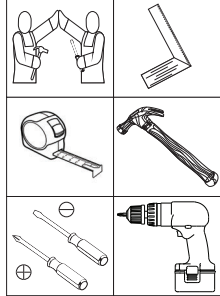
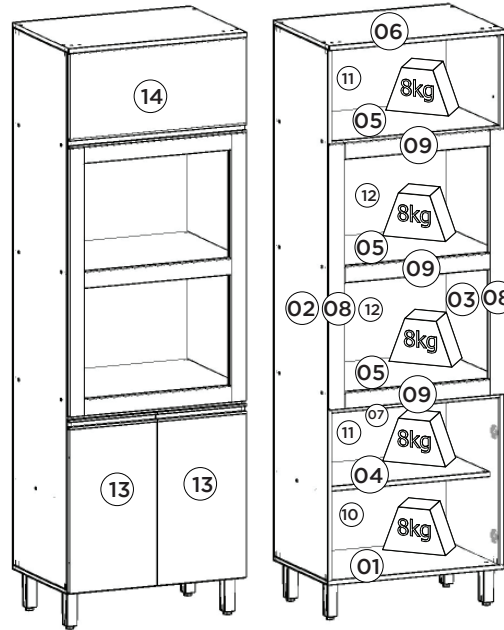

HENNInd. e Com. de Móveis Henn
Mondai - SC - Brasil

☎ +55 49 3674.3500

📱 @moveishenn
www.henn.com.br**INSTRUÇÕES DE MONTAGEM****INSTRUCCIONES DE MONTAJE
ASSEMBLY INSTRUCTIONS****Torre Quente 2 Fornos 715mm Connect | Torre caliente 2 Hornos 715mm Connect |
Hot Tower 2 Ovens 715mm Connect****Referência/Cor**c C69-35 - Duna/Cristal
c C69-42 - FendiRequisitos para montagem
Requisitos para la montaje
Assembly RequirementsImagens meramente ilustrativas
Imágenes meramente ilustrativas
Images for illustration onlyPesos máximos recomendados com carga distribuída
Peso máximo recomendado con la carga distribuída
Recommended maximum weight with distributed load.**AVISO**

Para limpeza de seu móvel, use uma flanela seca ou umedecida, e não utilize produtos químicos que possam danificar seu produto.

SISTEMA DE MONTAGEM

O sistema de montagem dos produtos, funciona de acordo com a ordem crescente dos números indicados no desenho. Ex: 01, 02, 03, 04... até a conclusão da montagem.

ADVERTENCIA

Para limpieza de su móvil, use una flanela seca o húmeda, y no utilice productos químicos que puedan dañar su producto.

SISTEMA DE MONTAJE

El sistema de montaje de los productos funciona de acuerdo con el orden creciente de los números indicados en el dibujo. Ej.: 01, 02, 03, 04... hasta la conclusión del montaje.

NOTICE

To clean your furniture, use a dry or wet cloth, and do not use chemicals that may damage your product.

ASSEMBLY SYSTEM

The products' assembly system works according to the increasing order of the indicated numbers. For example: 01, 02, 03, 04 ... to the end of the assembly.

Lista de Peças | Lista de piezas | List of parts

Item	Caixa Caja Box	Qtd Ctd Qty	Descrição Descripción Description	Medidas (mm) Dimensions (mm) Size (measurements) (mm)
01	2/2	01	Base Base Base	715x490x15
02	1/2	01	Lateral esquerda Lateral izquierda Left side	2030x490x15
03	1/2	01	Lateral direita Lateral derecha Right side	2030x490x15
04	1/2	01	Prateleira inferior Estante inferior Bottom Shelf	683x400x15
05	1/2 e 2/2	03	Prateleira maior Estante mayor Largest shelf	683x490x15
06	2/2	01	Tampo Tapa Top	715x505x15
07	1/2	01	Travessa inferior frontal Travesaño inferior frontal Front lower crossbar	683x60x15
08	1/2	02	Travessa lateral Travesaño lateral Lateral crossbar	1012x60x15
09	1/2	03	Travessa frontal Travesaño frontal Front crossbar	589x60x15
10	1/2	01	Fundo inferior Fondo inferior Bottom background	707x341x3
11	1/2	02	Fundo Fondo Bottom	707x376x3
12	2/2	02	Fundo central Fondo central Central fund	707x479x3
13	1/2	02	Porta Puerta Door	625x354x15
14	1/2	01	Porta basculante Puerta basculante Swing door	710x327x15

Ferragens | Herrajes | Hardware

A	B	C
Parafuso 7,0x40mm CHT. Tornillo 7,0x40mm CHT. Screw 7,0x40mm CHT.	Parafuso 5,0x50mm FLA. Tornillo 5,0x50mm FLA. Screw 5,0x50mm FLA.	Parafuso União 30mm Tornillo Unión 30mm Union Screw 30mm
D	E	F
Parafuso 3,5x40mm CHT. Tornillo 3,5x40mm CHT. Screw 3,5x40mm CHT.	Parafuso 4,0x25mm CHT. Tornillo 4,0x25mm CHT. Screw 4,0x25mm CHT.	Parafuso 3,5x14mm FLA. Tornillo 3,5x14mm FLA. Screw 3,5x14mm FLA.
G	H	I
Parafuso 3,5x12mm CHT. Tornillo 3,5x12mm CHT. Screw 3,5x12mm CHT.	Cavilha 8x25mm Cinta 8x25mm Dowel 8x25mm	Parafuso União 15mm Tornillo Unión 15mm Union Screw 15mm
J	K	L
Preço 10x10mm Clavo 10x10mm Nail 10x10mm	Fixador de fundos Fijador de fondos Bottom fixer	Conector de Montagem Conector de montaje Mounting Connector
M	N	O
Calço metal médio 0mm Calzón de metal medio 0mm Shim metal middle 0mm	Dobradilha metal 35mm Colo Baixo Bisagra de metal 35mm Colo Bajo Metal hinge 35mm Colo Low	Calço metal Super Alto 8mm Calzado metálico Super Alto 8mm Super 8mm metal chock
P	Q	R
Dobradilha metal 35mm Alta Bisagras metálicas 35mm Alta Metal hinge 35mm High	Suporte metal Soporte metálico Metal support	Puxador MOV 354mm Tirador MOV 354mm MOV 354mm Handle
S	T	U
Puxador MOV 710mm Tirador MOV 710mm MOV 710mm Handle	Kit Pistão a Gás 60N Kit Pistón a Gas 60N 60N Gas Piston Kit	Pé 145mm x 42mm Pie 145mm x 42mm Foot 145mm x 42mm
V	W	X
Batente PVC para Porta Parada de PVC para Puerta PVC Door Stop	Suporte de fixação Soporte de fijación Mounting bracket	Proteção para cantoneira Ángulo de protección Protection angle
Y	Z	AA
Giz de correção Tiza de corrección Chalk of correction	Bucha plástica 8mm Bucha de plástico 8mm 8mm plastic bushing	Etiqueta resinada Henn Etiqueta resinada Henn Henn resin label
AB	AC	AD
Adesivo tapa parafuso 10mm Adhesivo tapon de tornillo 10mm Bolt cover adhesive 10mm	Adesivo tapa parafuso 17mm Adhesivo tapon de tornillo 17mm Bolt cover adhesive 17mm	Sachê de cola Bolsa de pegamento Glue bag

O parafuso (C) deve ser usada somente quando este módulo for acoplado a outro módulo componível Henn.

El tornillo (C) se debe utilizar sólo cuando el módulo está conectado a otro módulo componible Henn.

The screw (C) should be used only when this module is attached to another Henn modular module.

RECOMENDAÇÃO

Para fixar o móvel na parede usar o suporte de fixação (W), o parafuso 3,5x14mm FLA (F), a Bucha 8mm (Z) e o parafuso 5,0x50mm FLA (B).

RECOMENDACIÓN

Para conectar el móvil a la pared con el soporte (W), tornillo 3,5 x14mm FLA (F), el casquillo de 8 mm (Z) y el 5,0 x50mm tornillo FLA (B).

RECOMMENDATION

To fix the furniture to the wall use the fixing bracket (W), the 3.5x14mm FLA (F) screw, the 8mm bushing (Z) and the 5.0x50mm FLA screw (B).

1º

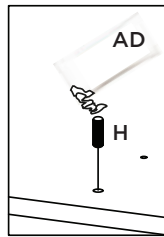
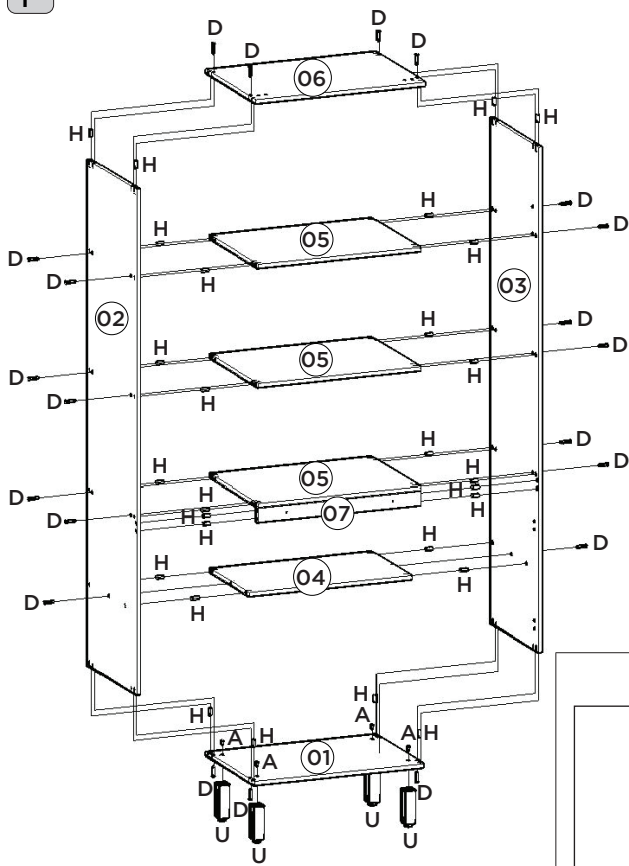

Utilizar o sachê de cola (AD) em todas as cavilhas (H) do produto.

Con el pegamento sobre (AD) en todos los pernos (H) producto.

Use the glue sachet (AD) on all the pegs (H) of the product.

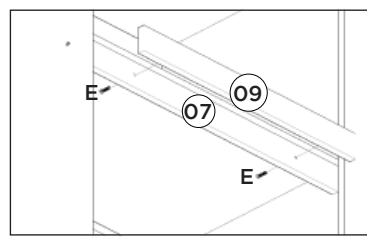

2º

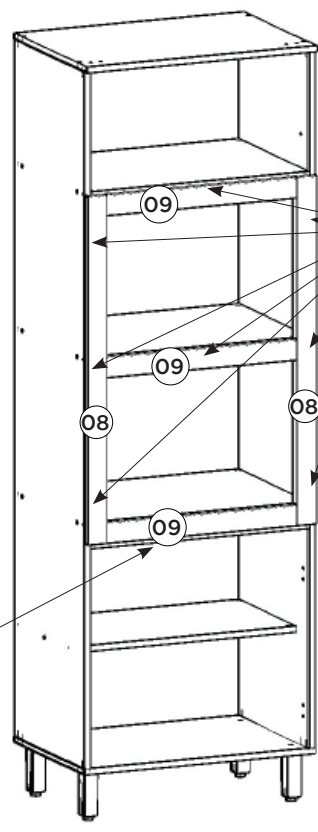

Conector de Montagem fixado Internamente

Conector de montaje fijado internamente

Mounting Connector fixed internally

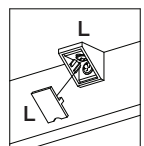
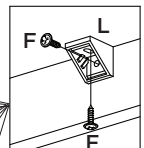

Suporte Metal fixado Internamente para unir as travessas

Soporte Metal fijado Internamente para unir los travesaños

Internally fixed metal bracket for joining the crossbars

3º

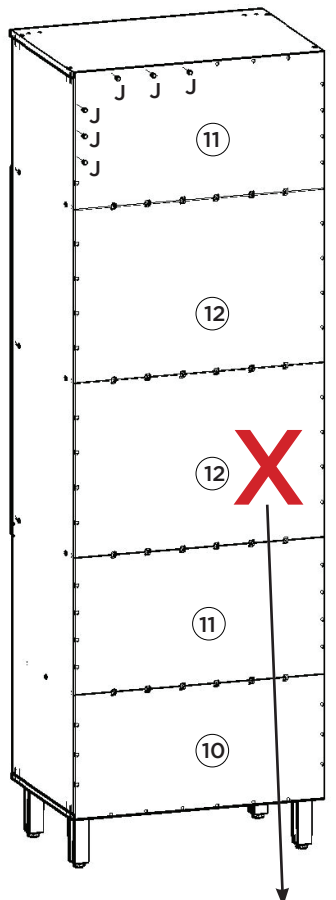

4º

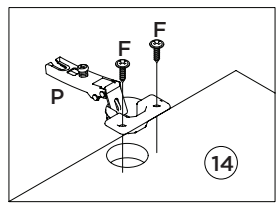
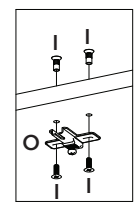
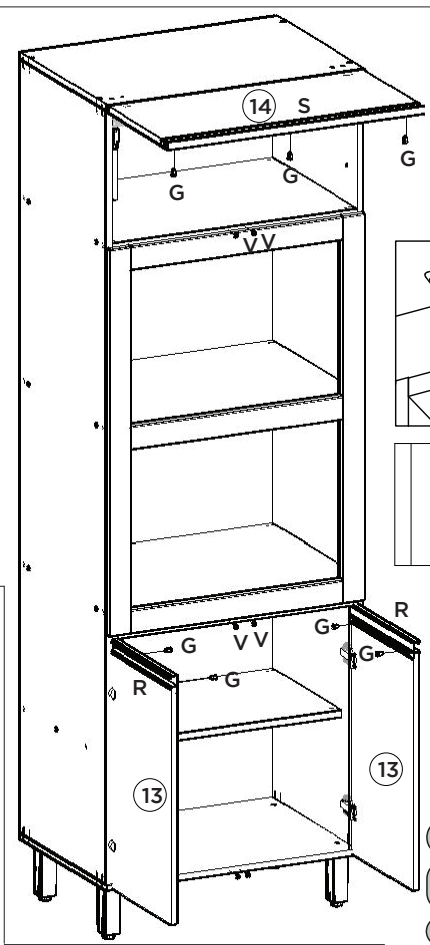
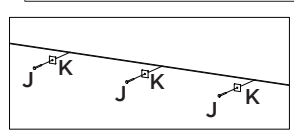
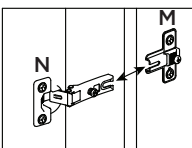
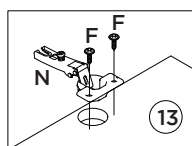
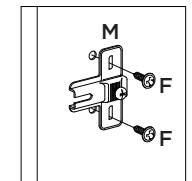

Vídeo: Instalar e regular Dobradiças

Vídeo: Instale y ajuste las bisagras

Vídeo: Install and adjust hinges

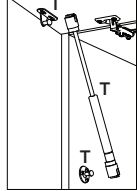
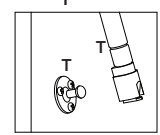
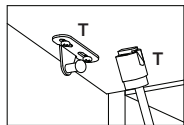
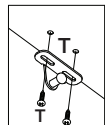
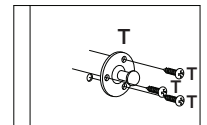
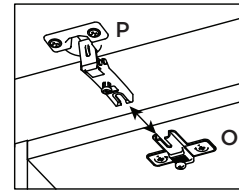

Vídeo: Dicas para instalar o Kit Pistão à Gás

Vídeo: Consejos para instalar el kit de pistón de gas

Vídeo: Tips for installing the Gas Piston Kit

ATENÇÃO: Por questão de segurança, recomendamos a não utilização do Fundo (12) caso o espaço seja utilizado por forno elétrico ou forno embutido, dessa forma, haverá melhor propagação do calor, evitando danos em seu móvel.

ADVERTENCIA: Por razones de seguridad, se recomienda no utilizar el Fondo (12) si el espacio es utilizado por horno eléctrico o una función de horno, de esta manera no será mejor propagación del calor, evitando el daño a su móvil.

ATTENTION: For safety reasons, we recommend not using the Wall (12) if the space is used by an electric oven or built-in oven, in this way, there will be better propagation of the heat, avoiding damage to your furniture.

