



















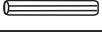

#### FERRAGENS / herrajes / hardware

<b>A</b>	Parafuso 3,5 x 40 Tornillo 3,5 x 40 Screw 3,5 x 40		<b>24</b>
<b>B</b>	Puxador Tirador Handle		<b>2</b>
<b>C</b>	Roldanas		<b>4</b>
<b>D</b>	Parafuso 3,5 x 25 c/c Tornillo 3,5 x 25 Screw 3,5 x 25		<b>6</b>
<b>E</b>	Prego 10 x 10 c/c Clavo 10 x 10 Nail 10 x10		<b>80</b>
<b>F</b>	Parafuso 3,5 x 12 c/c Tornillo 3,5 x 12 Screw 3,5 x 12		<b>50</b>
<b>G</b>	Prego 13 x 15 c/c Clavo 13 x 15 Nail 13 x 15		<b>4</b>
<b>H</b>	Fixador Fijador Fixer		<b>10</b>
<b>I</b>	Suporte Apoyo Support		<b>8</b>
<b>J</b>	Suporte Cabideiro Apoyo Percha Support Hanger		<b>4</b>
<b>K</b>	Cantoneira 22x22 Esquinera Corner		<b>10</b>
<b>L</b>	Sapata Zapata Shoe		<b>6</b>
<b>M</b>	Cavilha 6 x 30 Tacos Pegs		<b>4</b>
<b>N</b>	Corrediça Metálica 350mm Corrediza Slider		<b>1</b>
<b>O</b>	Distanciador p/ Corrediças Distanciador Distancer		<b>4</b>
<b>P</b>	Parafuso 3,5 x 16 c/c Tornillo 3,5 x 16 Screw 3,5 x 16		<b>12</b>
<b>Q</b>	Parafuso 3,5 x 14 c/c Tornillo 3,5 x 14 Screw 3,5 x 14		<b>6</b>
<b>R</b>	Cola Pegamento Glues		<b>1</b>
<b>T</b>	Trilho pvc (U) superior		<b>1</b>
<b>Z</b>	Trilho aluminio inferior		<b>1</b>

#### MATERIAL PARA MONTAGEM Material Para Armado / Assembly Material

**MARTELO**  
Martillo  
Hammer

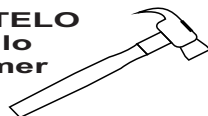

**CHAVE**  
Destornillador  
Screwdriver

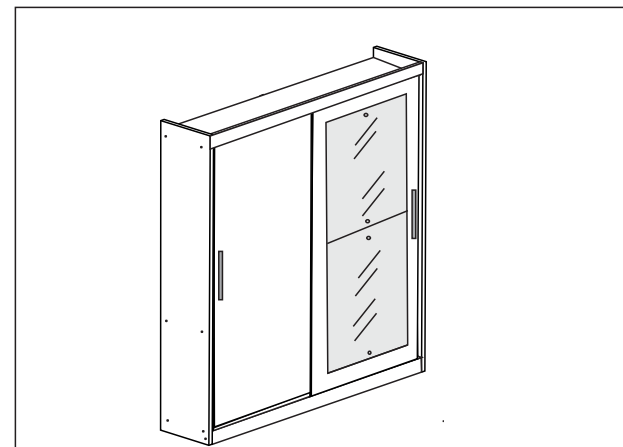
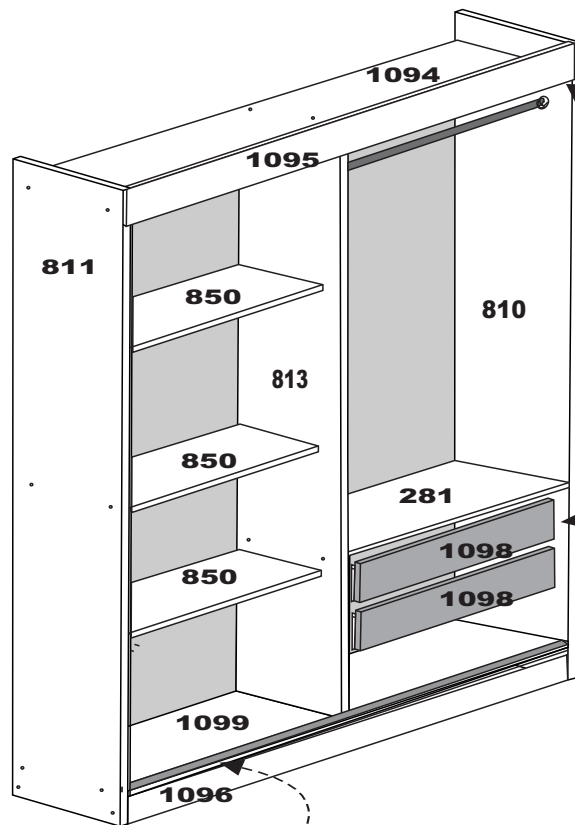

#### NUMERAÇÃO DE PEÇAS

<b>811</b>	Lateral Esquerda / Lateral izquierda/ left side
<b>810</b>	Lateral direita / Lateral derecha/ right side
<b>1096</b>	Rodapé Frontal / Rodepié Frente/ front footer
<b>1097</b>	Rodapé traseiro / Rodapié trazero/ back drawer
<b>1095</b>	Roda-forro / Roda-forro/wheel - liner
<b>1098</b>	Frente gaveta / Delantera cajón/ back drawer
<b>122</b>	Lateral gaveta / Lateral cajón/ side drawer
<b>1103</b>	Trazeiro gaveta / Trazeiro cajón/ back side drawer
<b>1101</b>	Fundo gaveta / Fondo cajón/ back drawer
<b>1102</b>	Costas / Espalda/ back
<b>1099</b>	Porta / Puerta/big door
<b>1094</b>	Tampo superior / Tampo superior/ top higher
<b>1099</b>	Tampo baixo / Tampo abajo/ top dawn
<b>813</b>	Divisão / División
<b>850</b>	Prateleira Móvel / Prateleira Mueble/mobile
<b>281</b>	Prateleiras fixa

#### ACESSÓRIOS

N°	DESCRIÇÃO
<b>00086</b>	Pau cabide / Madera percha/stick hanger
<b>101</b>	Espelhos
<b>1010-s</b>	Trilho superior
<b>1010-i</b>	Trilho inferior
<b>69222</b>	Kit roldana

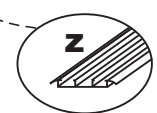
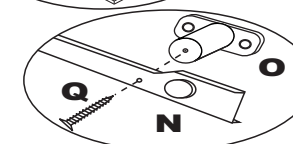
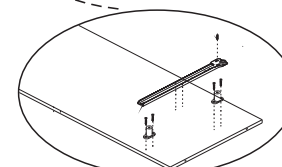

# 1° Passo / 1 Paso / 1 Step

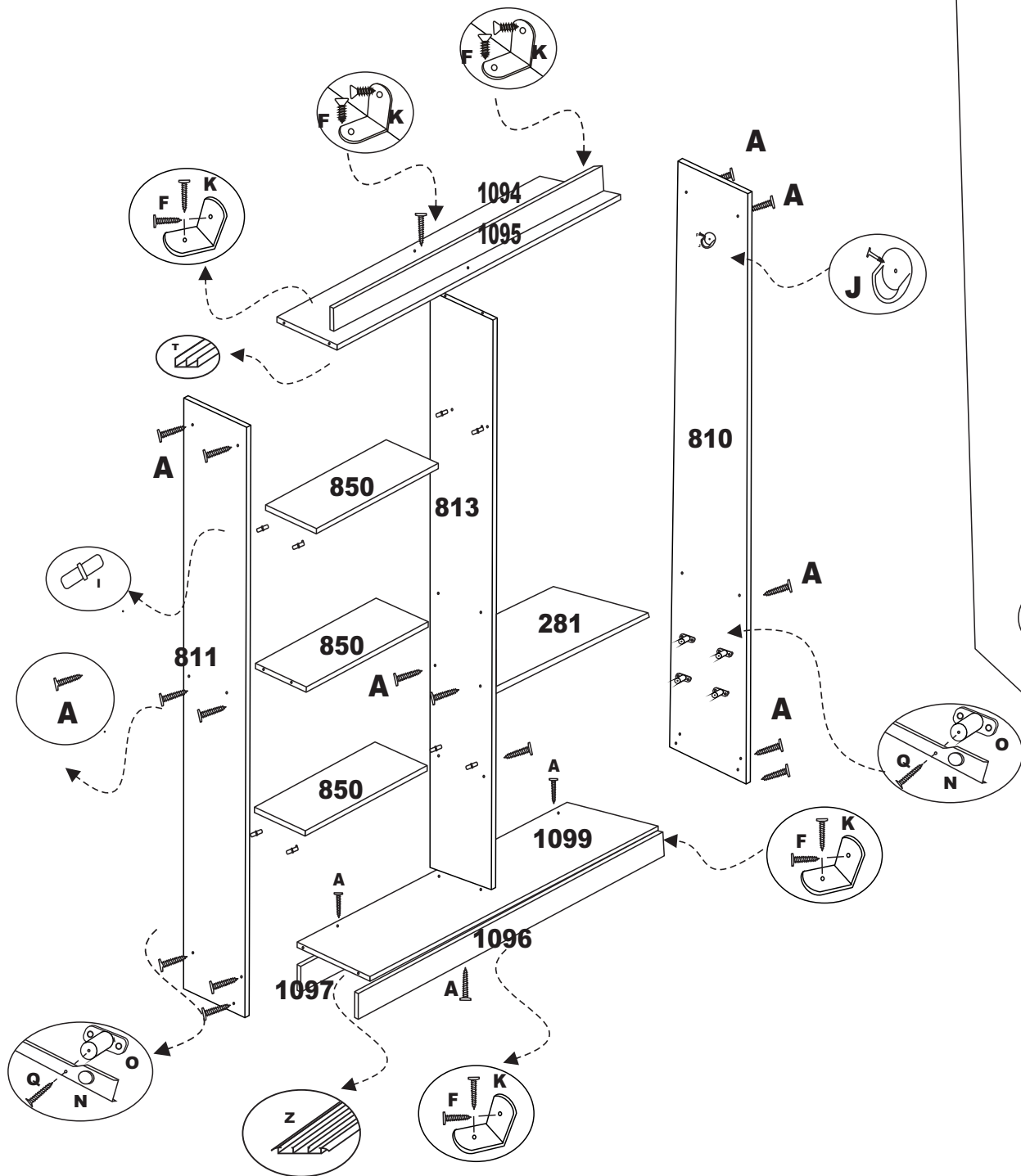

# 2° Passo / 2 Paso / 2 Step

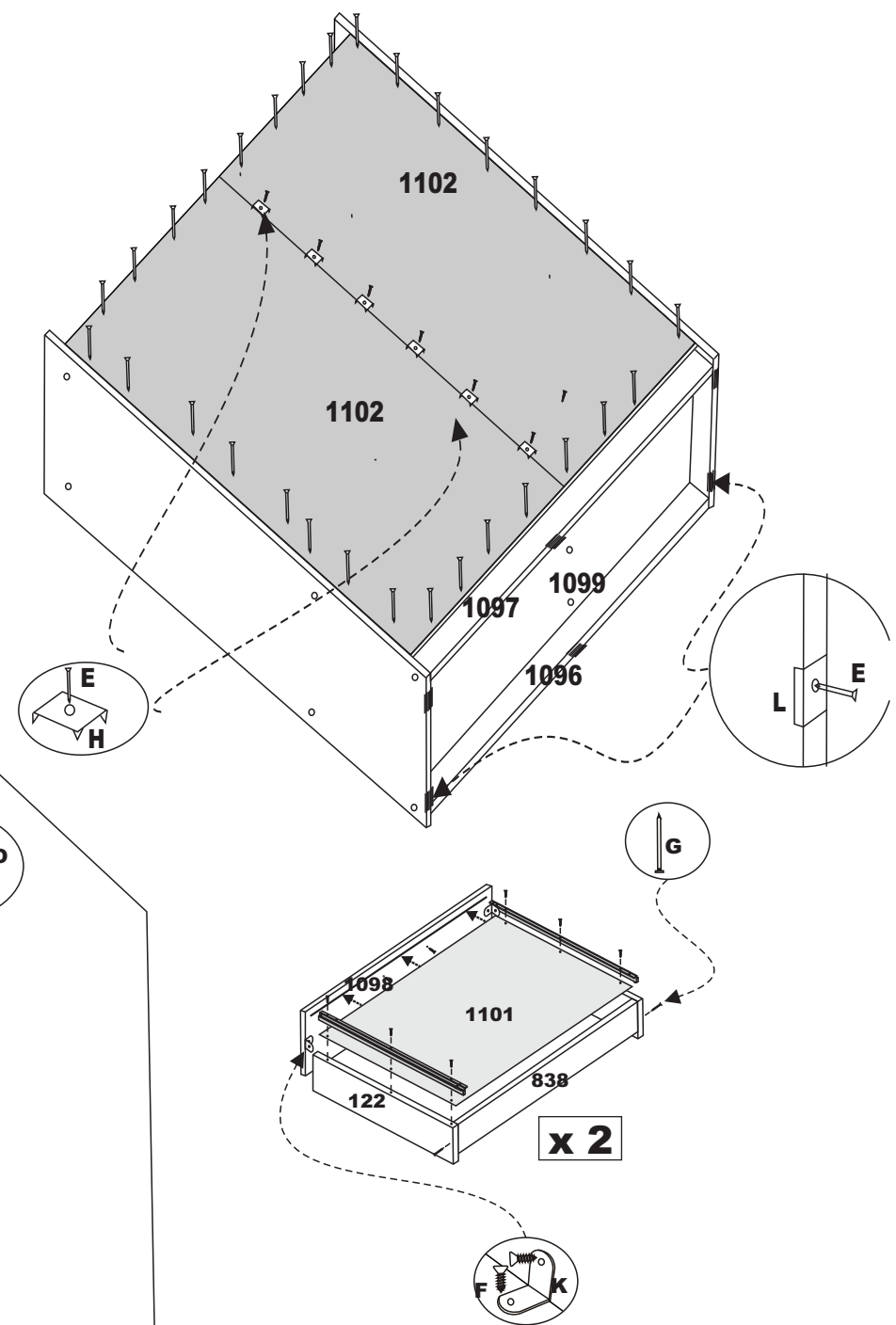

# ATENÇÃO MONTAGEM TRILHOS

3º Passo / 3 Paso / 3 Step

**Obs:**  
Na parte de cima, encaixa a porta dentro do trilho 'U'.

**Observación:**  
En la parte superior, se ajusta a la puerta en la barra 'U'.

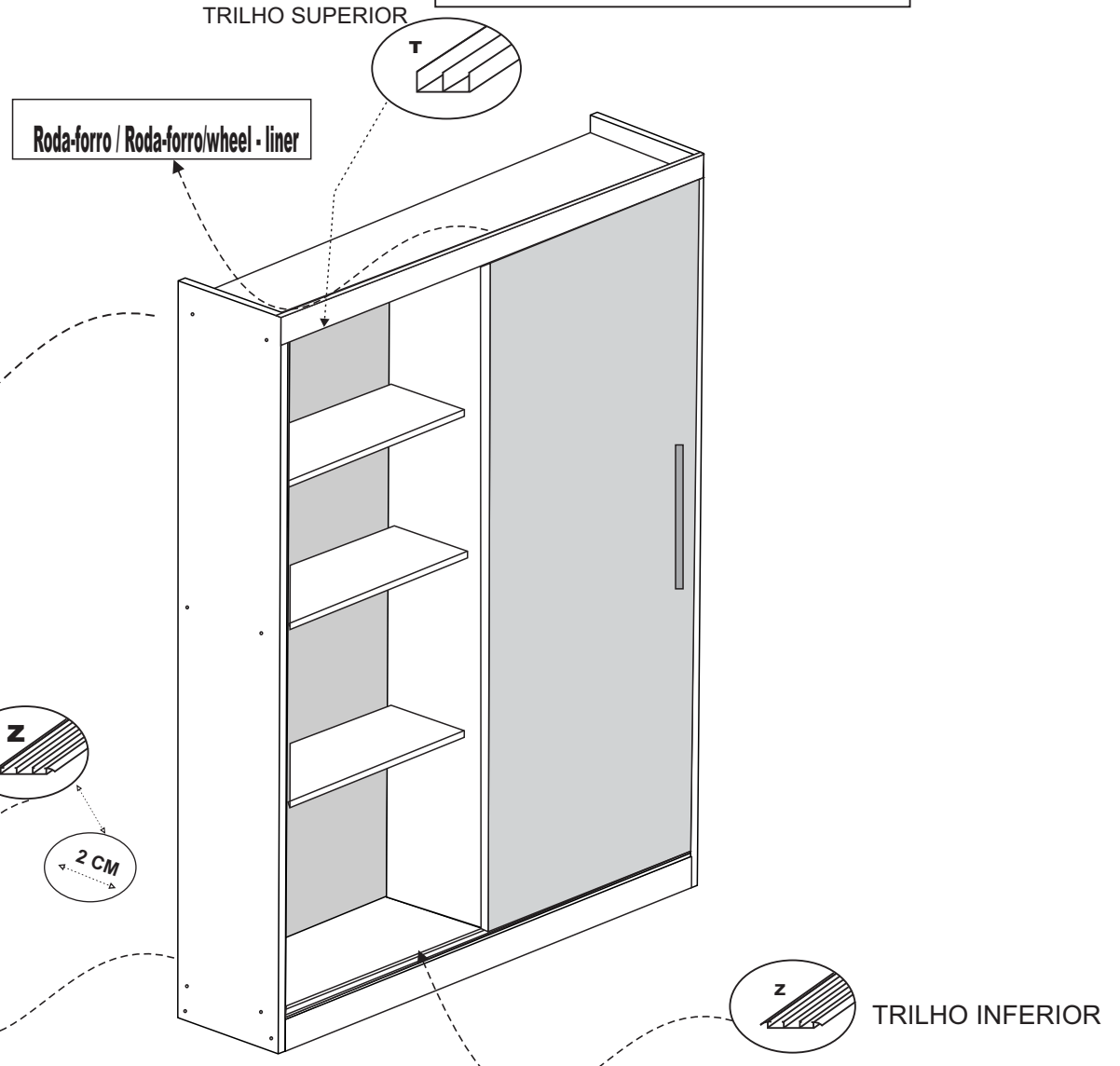
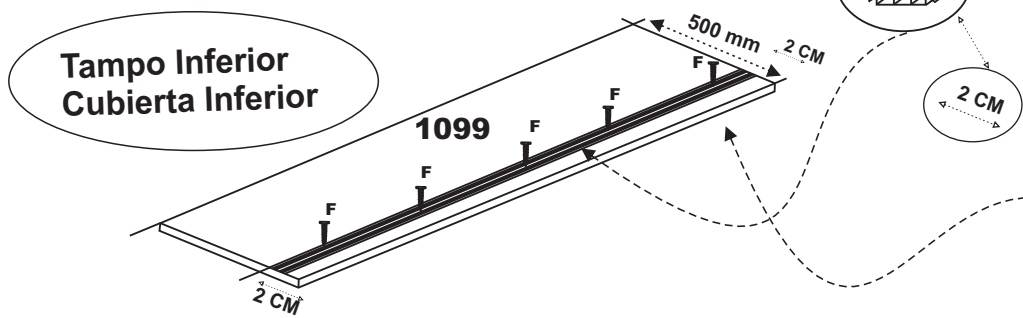
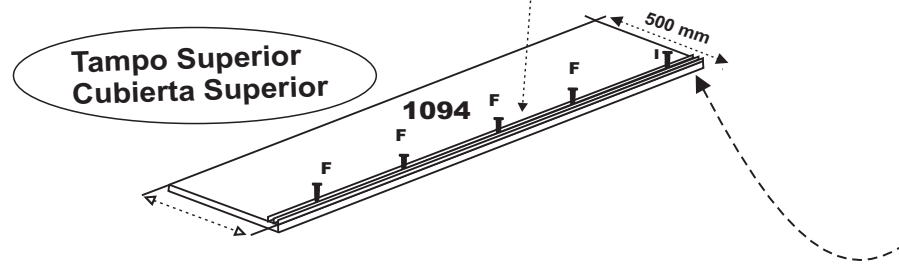
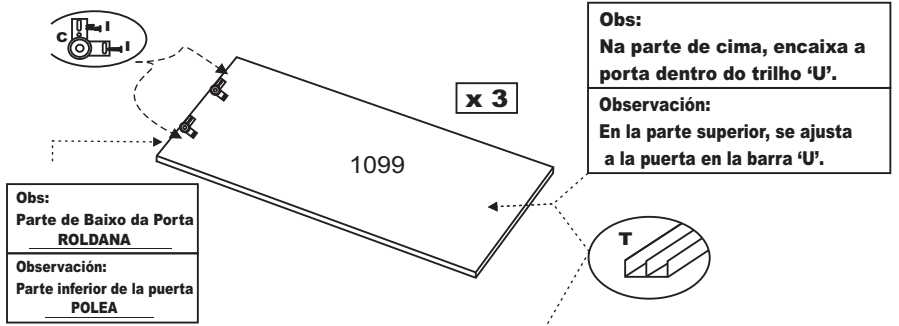

# ATENÇÃO MONTAGEM PORTAS ESPELHOS.PUXADORES

4º Passo / 4 Paso / 4 Step

*Por puxadores, portas lateral  
do roupeiro.*

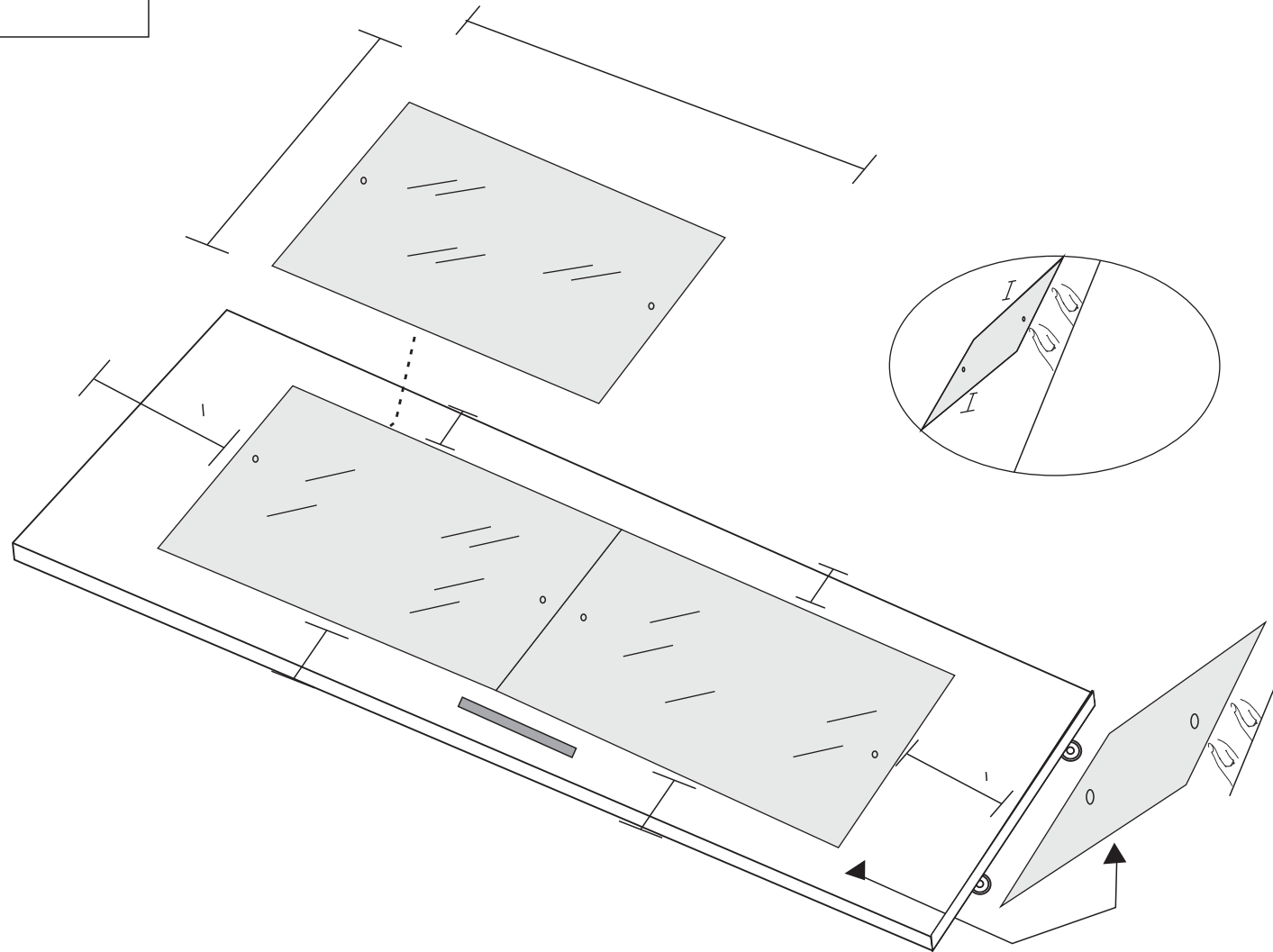
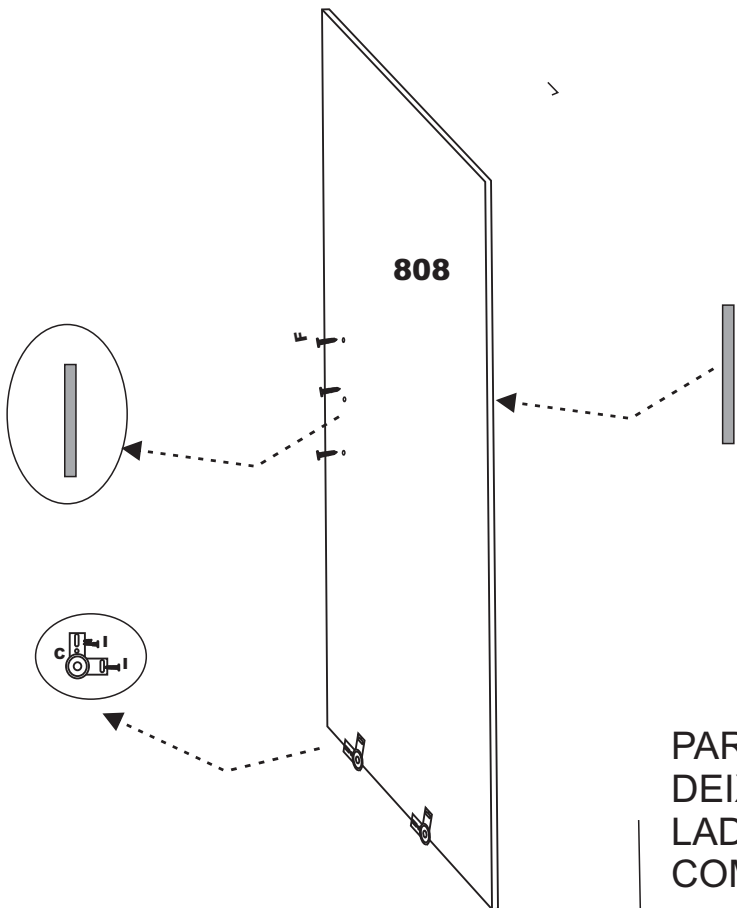

PARA INICIAR A MONTAGEM ESPELHO  
DEIXANDO A MEDIDA LATERAL COM ... MM CADA  
LADO DA PORTA.  
COMO MOSTRA DESENHO  
E EMPARAFUSAR O ESPELHO NA PORTA.