

**Estante para livros  
London**

## Informações Utéis

Para assegurar a garantia, é recomendada a prévia conferência das peças e componentes, bem como a leitura do manual de montagem.

Qualquer dúvida sobre os nossos produtos você pode entrar em contato via nosso canal de atendimento:

### Limpeza

- Para começar a limpeza, retire o pó com flanela seca, depois use um pano macio, levemente umedecido com água. É possível o uso de detergente neutro, ou sabão neutro com água;
- De tempos em tempos, reaperte os parafusos do produto para garantir sua estabilidade e durabilidade;
- Tenha cuidado com a disposição de aparelhos eletrônicos sobre o móvel, a falta de ventilação e excesso de calor podem prejudicar a durabilidade e acabamento do seu produto.

Para mais dicas amigáveis e inspirações de decoração acesse nosso blog: <https://www.madeiramadeira.com.br/central-de-dicas>

## Siga MadeiraMadeira:



madeiramadeira.com.br

# 9

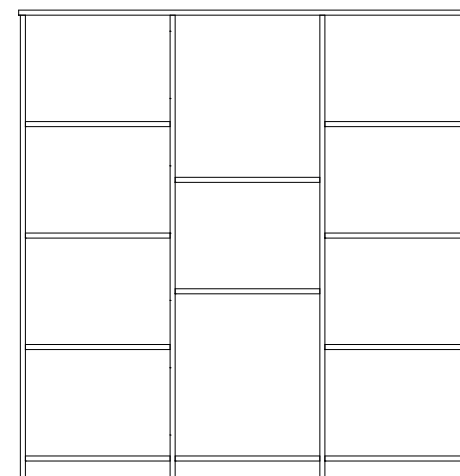
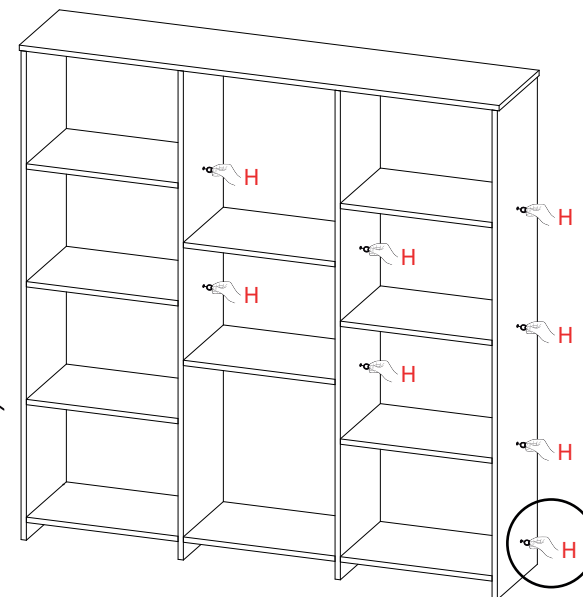
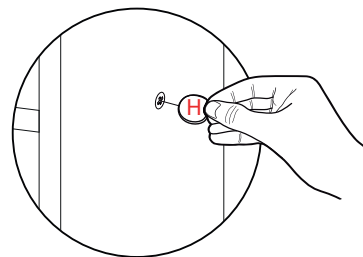

7

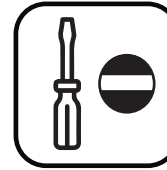
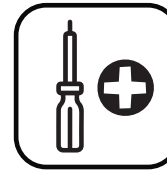
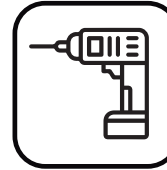
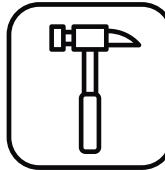
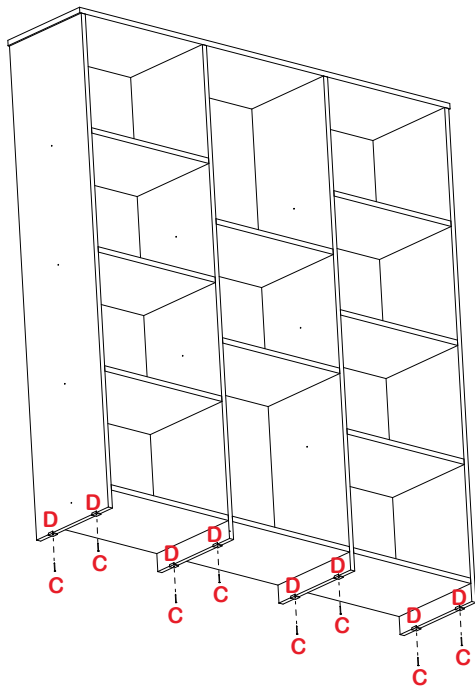
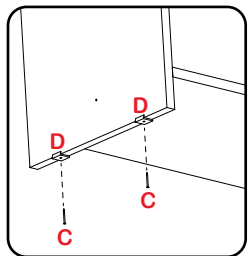

8

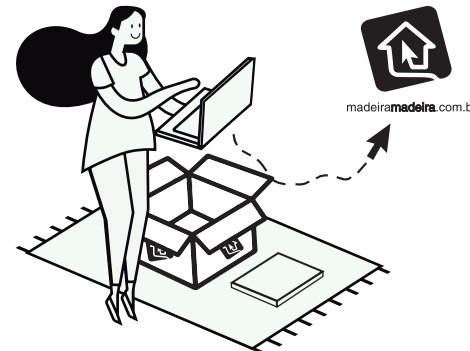
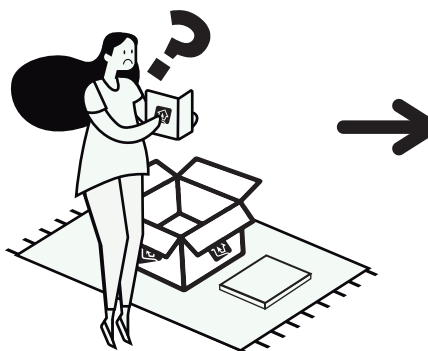
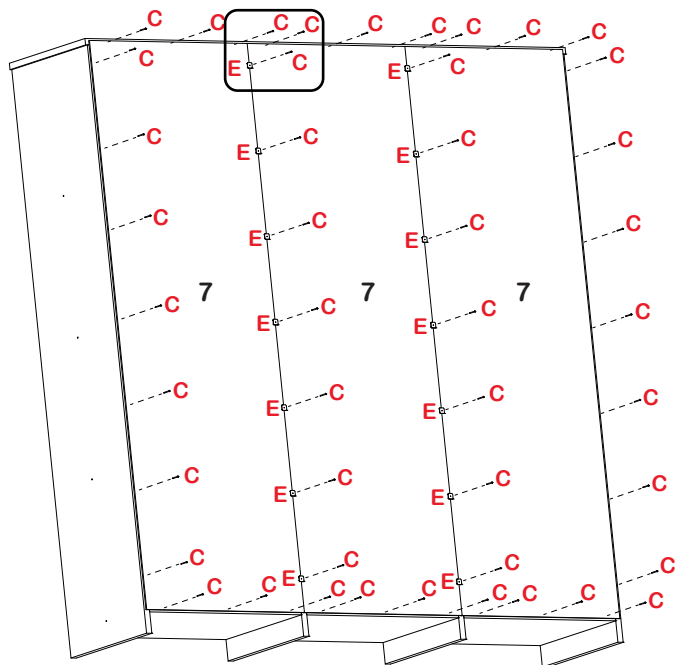
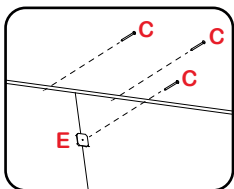

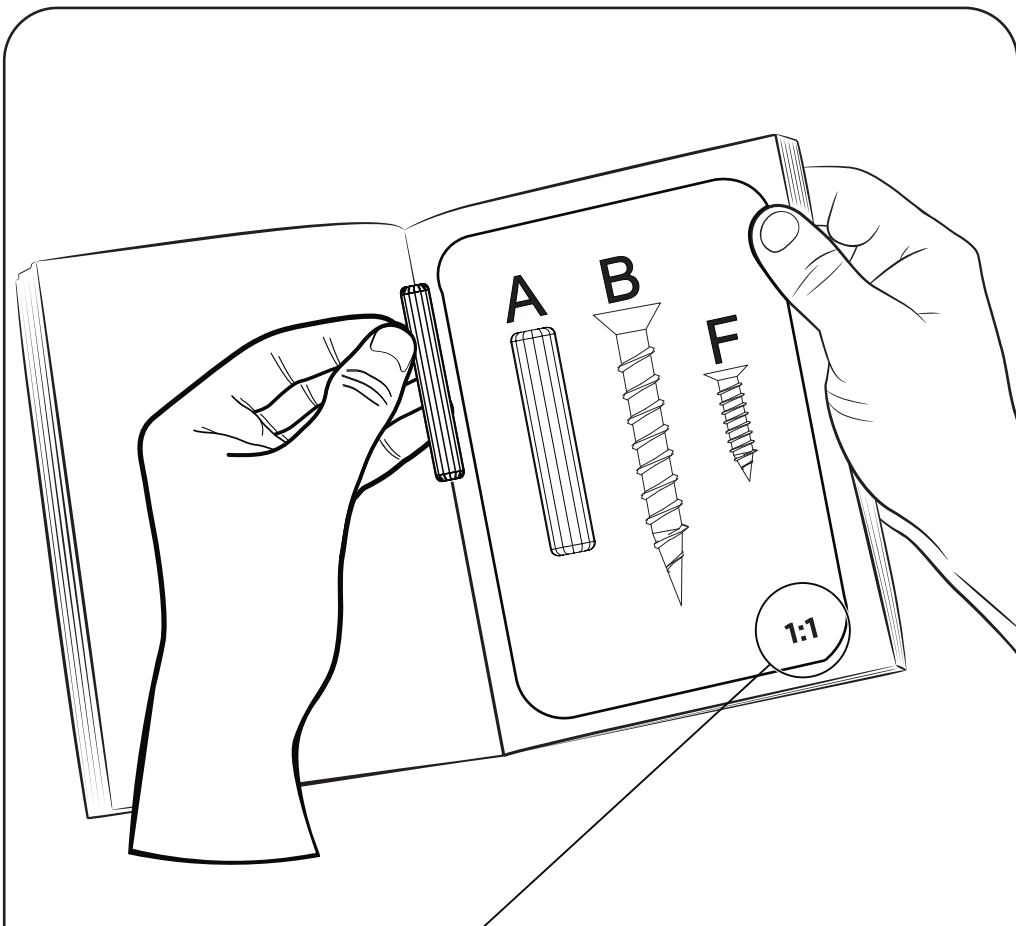

### Preste Atenção!

As ferragens dos nossos manuais são sempre apresentadas nas mesmas proporções da peça na vida real. Caso apareça alguma dúvida no decorrer do processo de montagem, coloque a ferragem ao lado do desenho e faça a consulta :D



### Símbolos:

-  Parafuso Phillips
-  Parafuso Fenda
-  Parafuso Allen

# 5

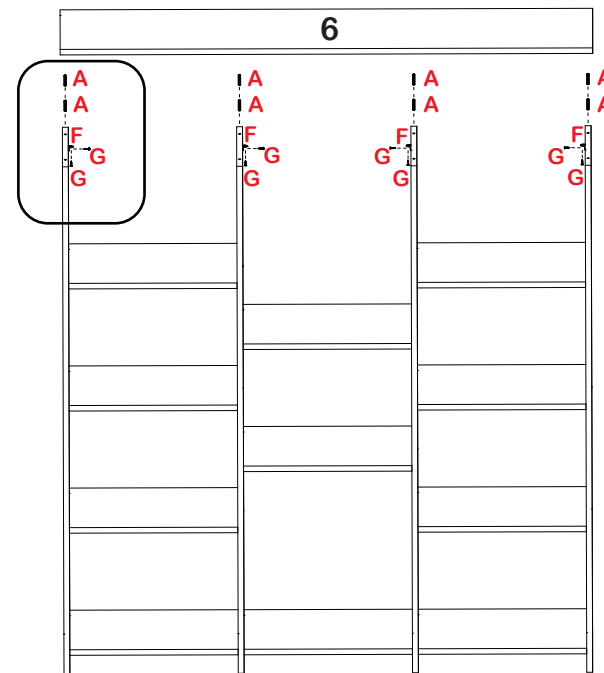

# 6

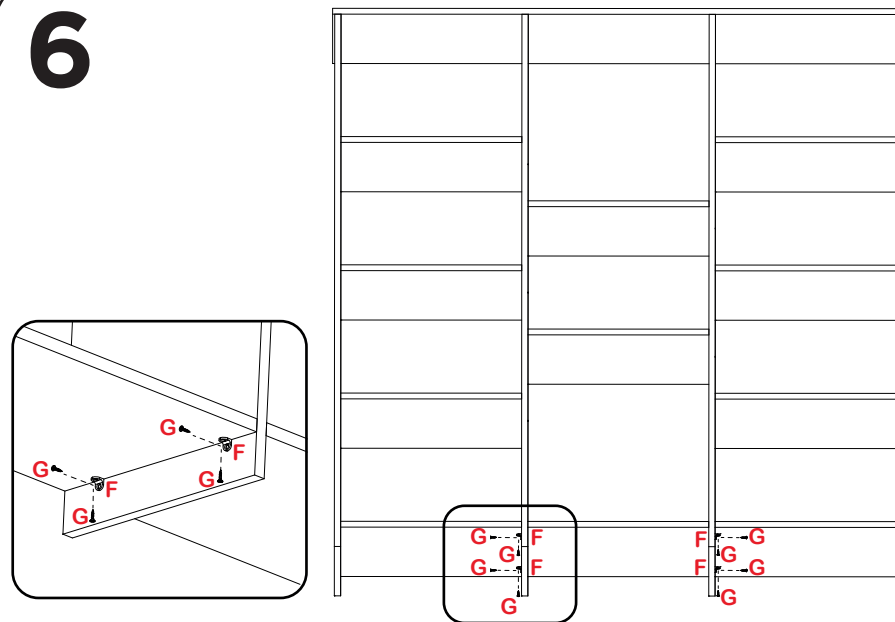

# 3

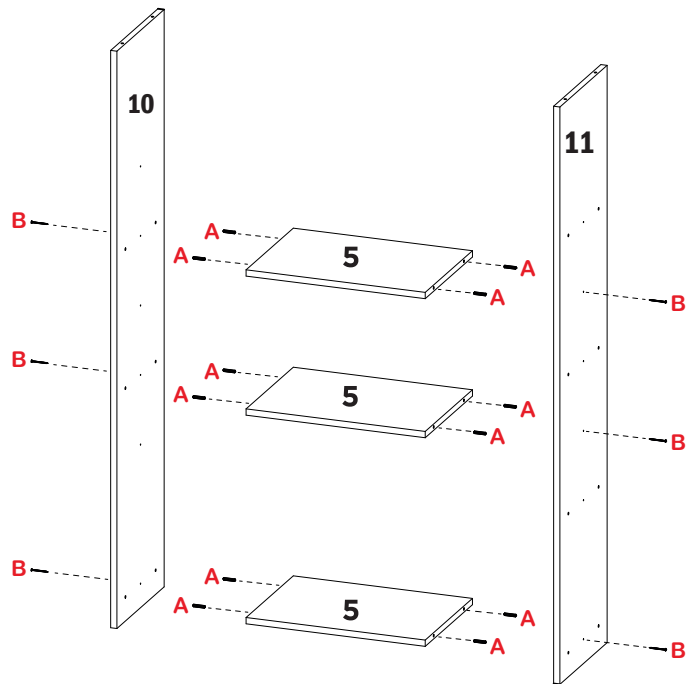

# 4

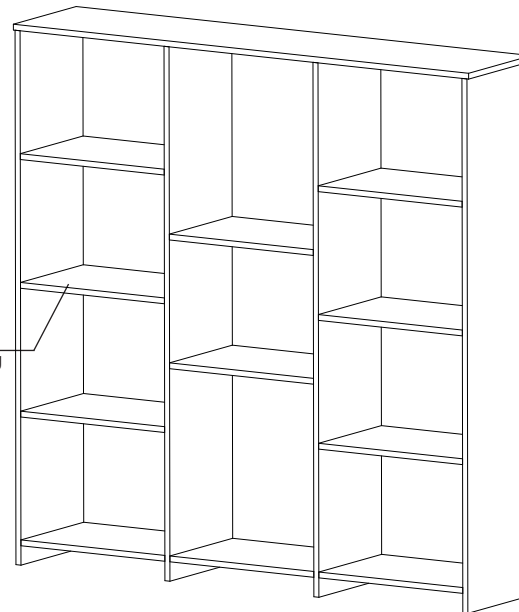
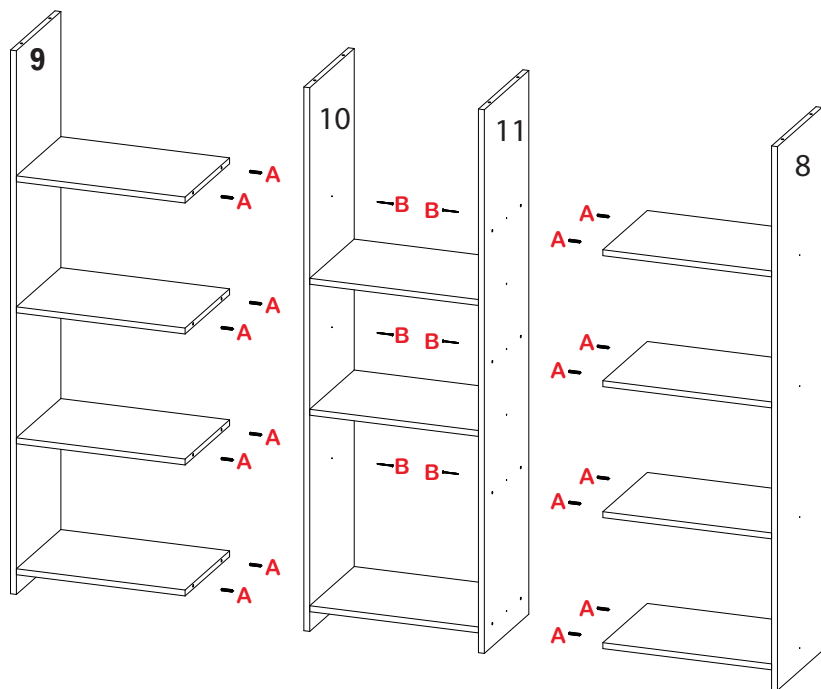

**7 KG**  
PRATELEIRAS  
Suporta até 7 kg  
por prateleira

TAMANHO ESCALA  
REAL PARAFUSOS

Parafuso 3,5x40

Parafuso 3,5x25

Parafuso 3,5x14

## LISTA DE FERRAGENS

Nº PEÇA	PEÇA	DESCRIÇÃO	QTD	CÓDIGO DE FERRAGENS
A		Cavilha 6X30 mm	52 un.	063019
B		Parafuso 3,5 x 40	20 un.	354019
C		Pregos	60un.	101019
D		Sapata 15x15	8 un.	1515B19
E		Fixador fundo	18 un.	6619
F		Cantoneira	12 un.	32619
G		Parafuso 3,5 x 14	24 un.	351419
H		Tapa Furo	18 un.	206B19

## LISTA DE PEÇAS

Nº PEÇA	DESCRIÇÃO	QTD	DIMENSÕES (mm)			PESO UNT (KG)	CÓDIGO DE REFERÊNCIA
			COMP.	LARG.	ESP.		
8	LATERAL DIREITA	01	1360	300	15	4,04	521211601
9	LATERAL ESQUERDA	01	1360	300	15	4,04	521211602
10	DIVISÓRIA ESQUERDA	01	1360	300	15	4,04	521211603
11	DIVISÓRIA DIREITA	01	1360	300	15	4,04	521211604
5	PRATELEIRAS	11	430	300	15	1,26	521211605
6	TAMPO	01	1360	300	15	4,00	521211606
7	FUNDOS 3MM	3	1330	446,7	3	2,00	521211607

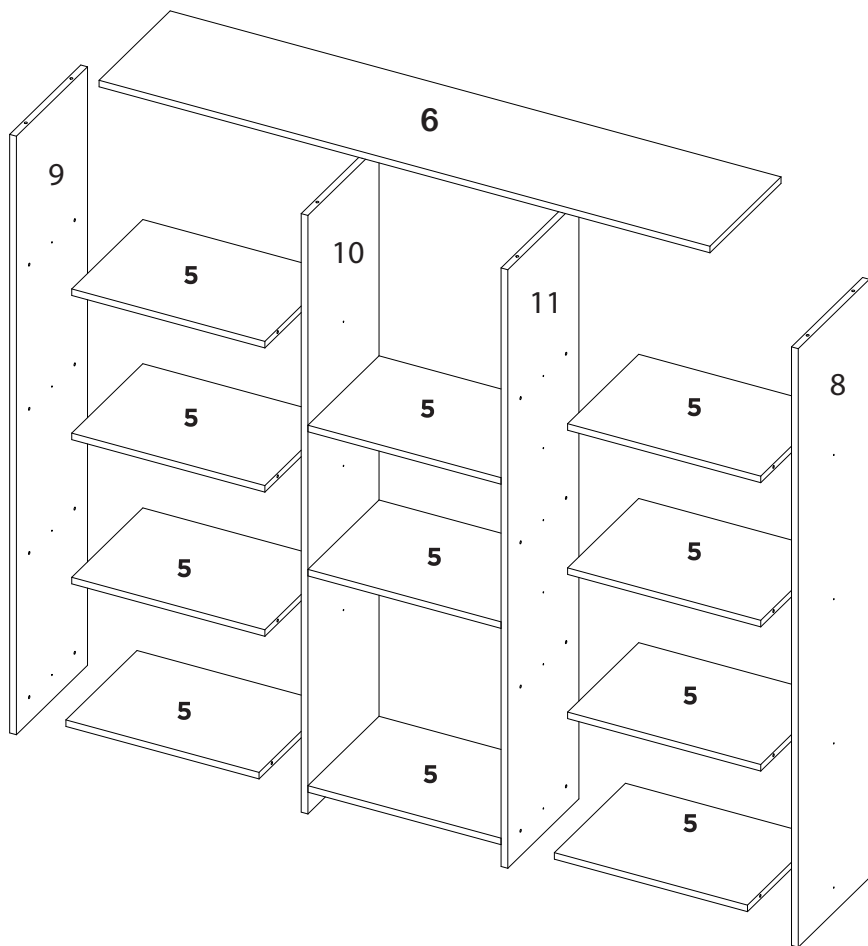

# 1

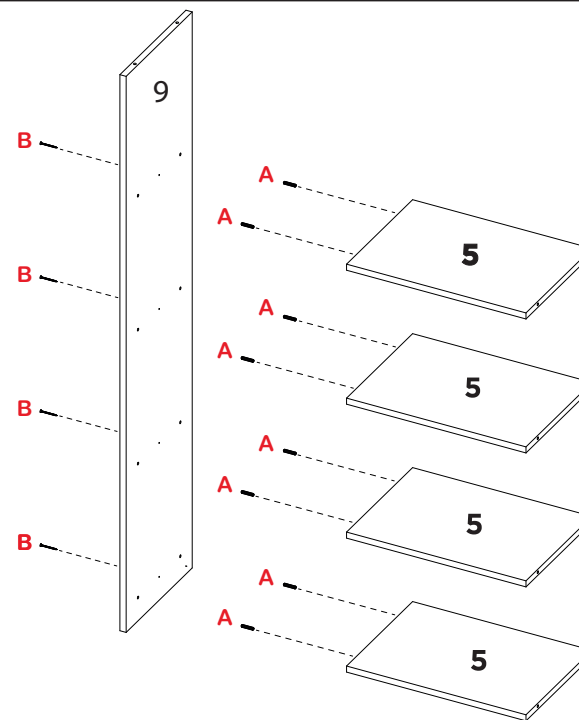

# 2

