

INSTRUÇÕES DE MONTAGEM

INSTRUCCIONES DE MONTAJE
ASSEMBLY INSTRUCTIONS

Canto Closet Seletto 02 Portas

MC05-133 Areia HP
MC05-184 Areia HP/Jequitibá

Opção 1
Opción 1
Option 1

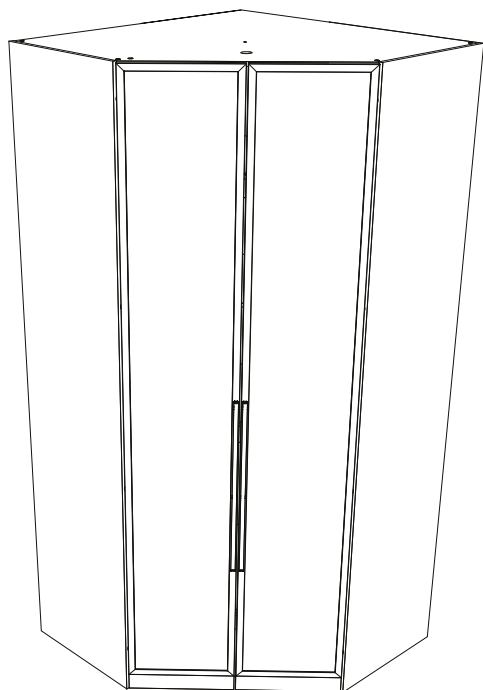

Opção 2
Opción 2
Option 2

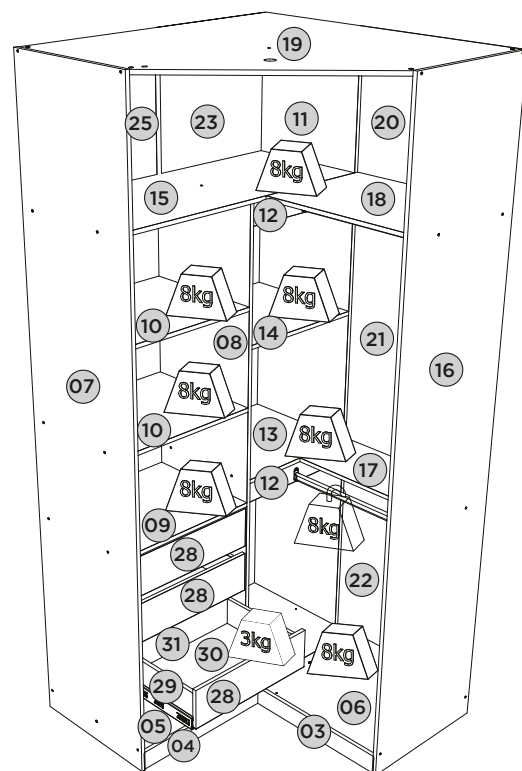
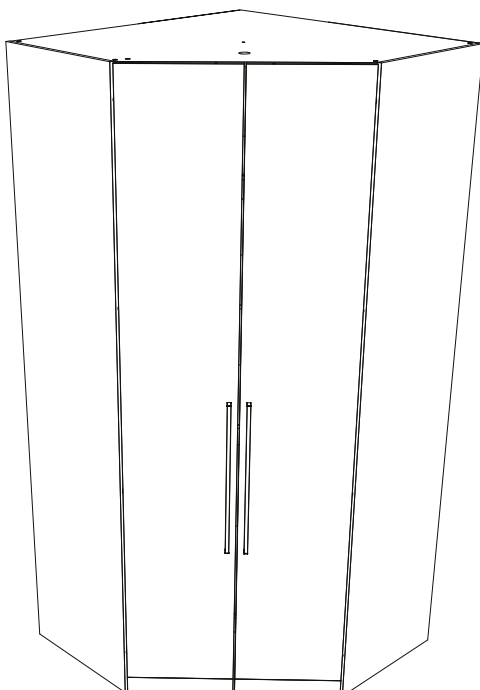

Pesos máximos recomendados com carga distribuída
Peso máximo recomendado con la carga distribuida
Recommended maximum weights with evenly distributed.

Requisitos para montagem
Requisitor para la montaje
Assembly Requirements

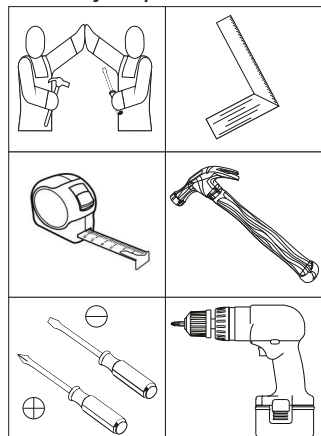

Imagens meramente ilustrativas
Imágenes meramente ilustrativas
Images for illustration only

A união (AB) deve ser usada somente quando este módulo for acoplado a outro módulo componível Henn, para unir duas peças de 15mm. Caso ele seja usado separadamente, a utilização do união não se faz necessário.



La unión (AB) se debe utilizar sólo cuando el módulo está acoplado a otro módulo composable Henn, para unirse a dos 15mm piezas. Si se utiliza por separado, el uso de unión no es necesario.



The union (AB) should be used only when this module is coupled to another Module Henn, to join two pieces of 15mm. If it is used separately, the use of the union is not necessary.



AVISO

Para limpeza de seu móvel, use uma flanela seca ou umedecida, e não utilize produtos químicos que possam danificar seu produto.

SISTEMA DE MONTAGEM

O sistema de montagem dos produtos, funciona de acordo com a ordem crescente dos números indicados no desenho. Ex.: 01, 02, 03, 04... até a conclusão da montagem.

ADVERTENCIA

Para limpieza de su móvil, use una franela seca o húmeda, y no utilice productos químicos que puedan dañar su producto.

SISTEMA DE MONTAJE

El sistema de montaje de los productos funciona de acuerdo con el orden creciente de los números indicados en el dibujo. Ej.: 01, 02, 03, 04... hasta la conclusión del montaje.

NOTICE

To clean your furniture, use a dry or wet cloth, and do not use chemicals that may damage your product.

ASSEMBLY SYSTEM

The products' assembly system works according to the increasing order of the indicated numbers. For example: 01, 02, 03, 04 ... to the end of the assembly.

1

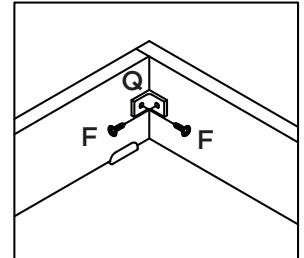
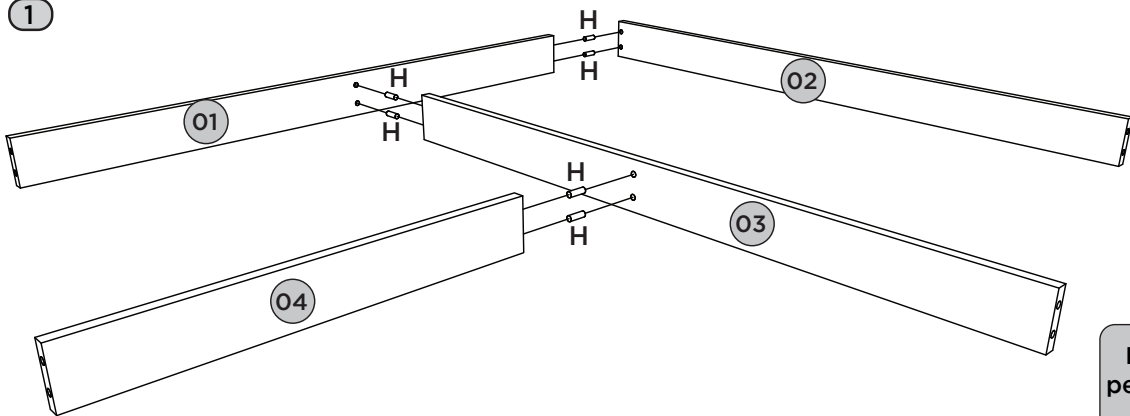

Fixação das cantoneiras nas peças de nº (01 e 02), (01 e 03) e (03 e 04).

La fijación de los ángulos en el número de piezas (01 y 02), (01 y 03) y (03 y 04).

Fixation of the angles in pieces (01 and 02), (01 and 03) and (03 and 04).

2

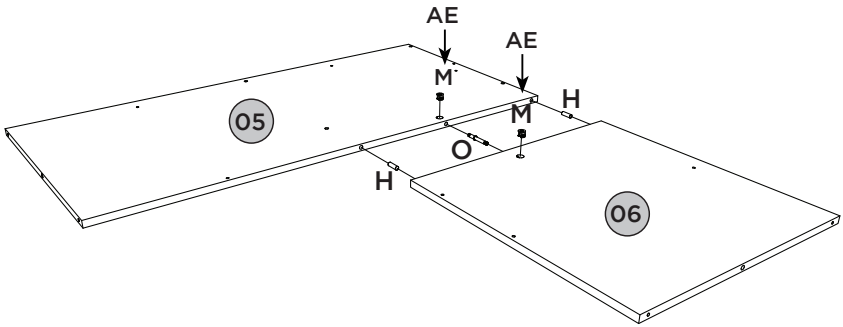

3

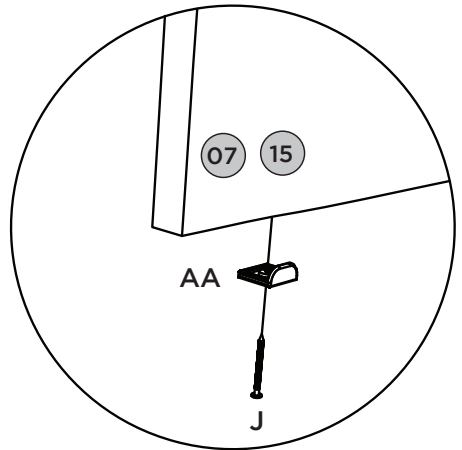
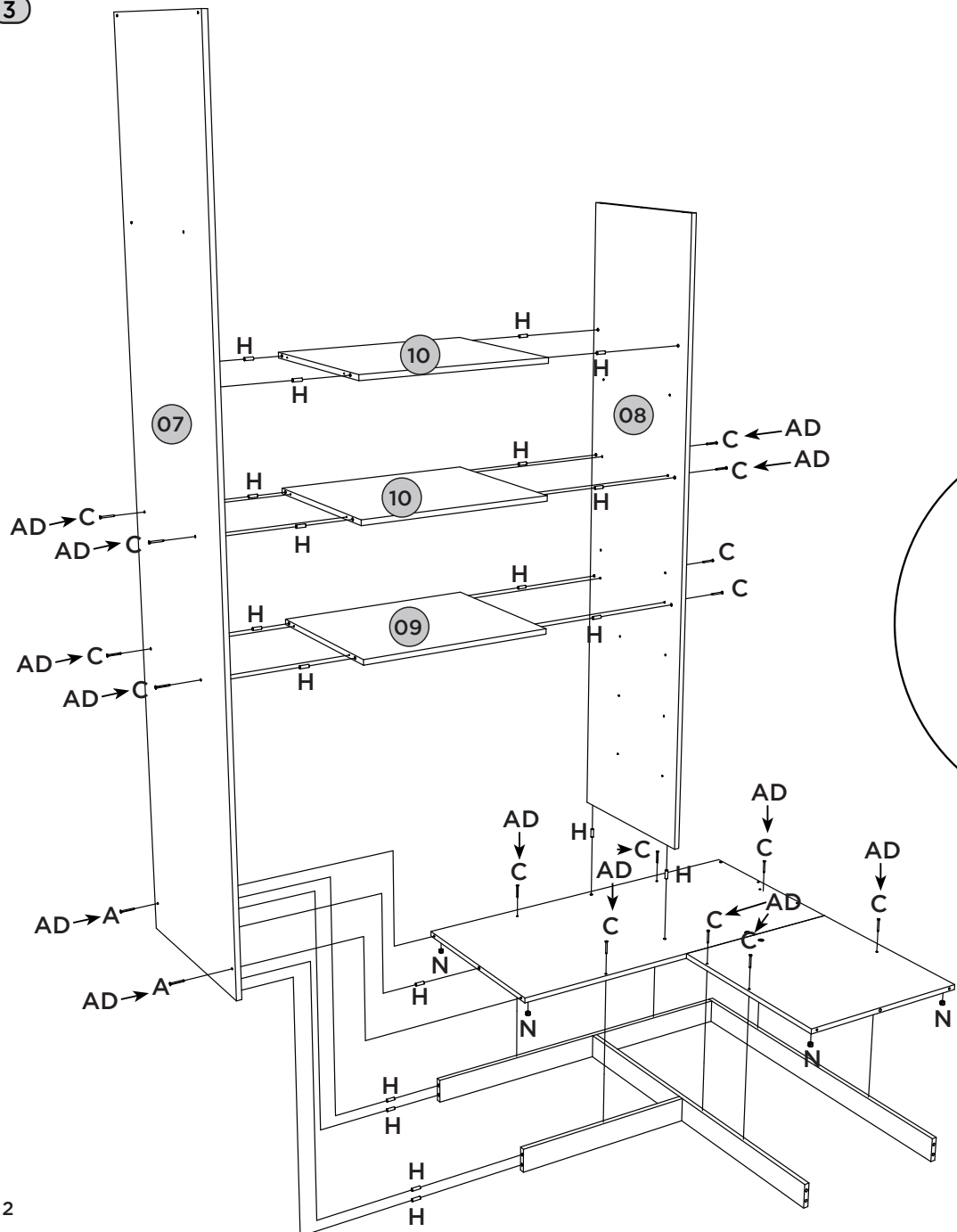

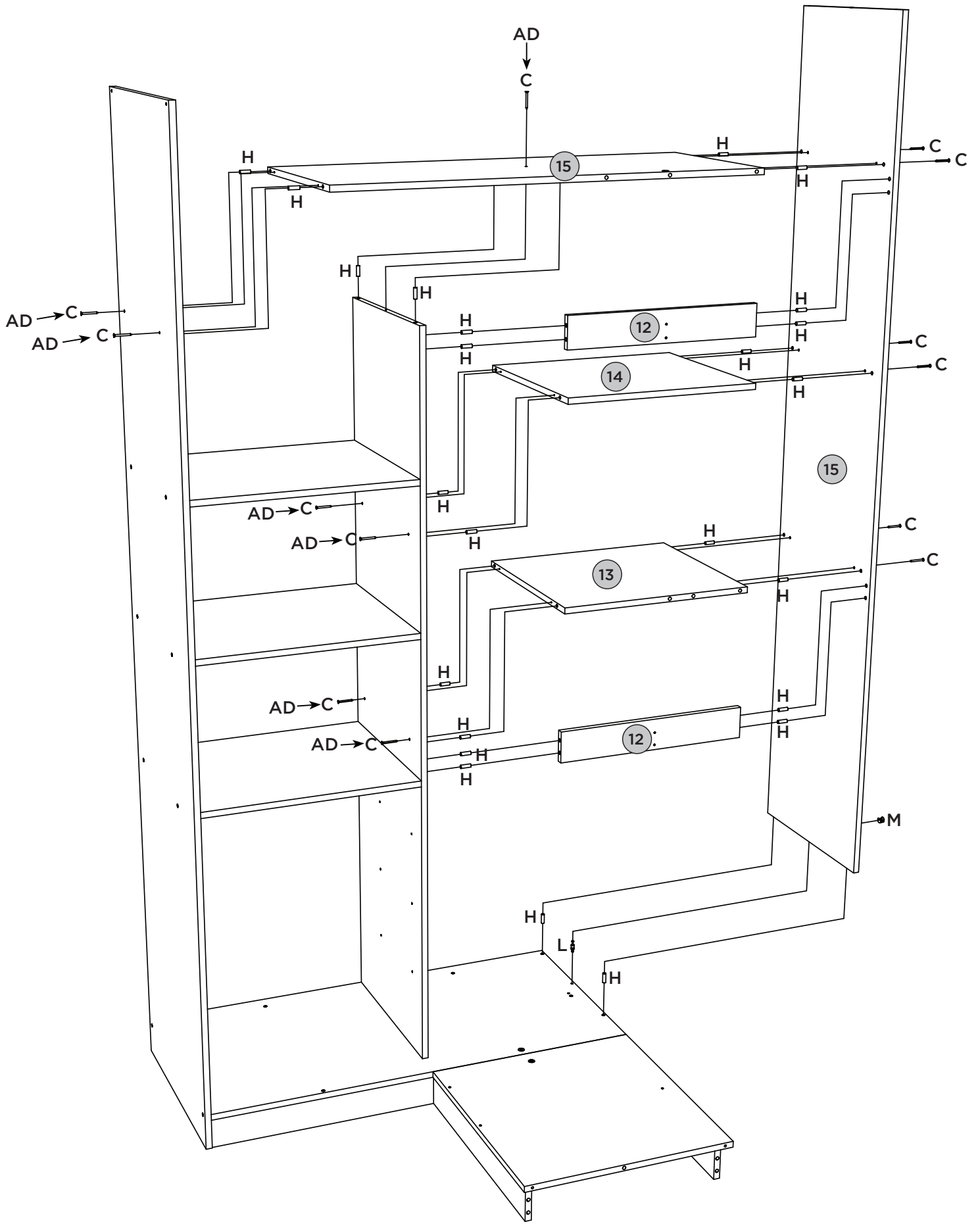

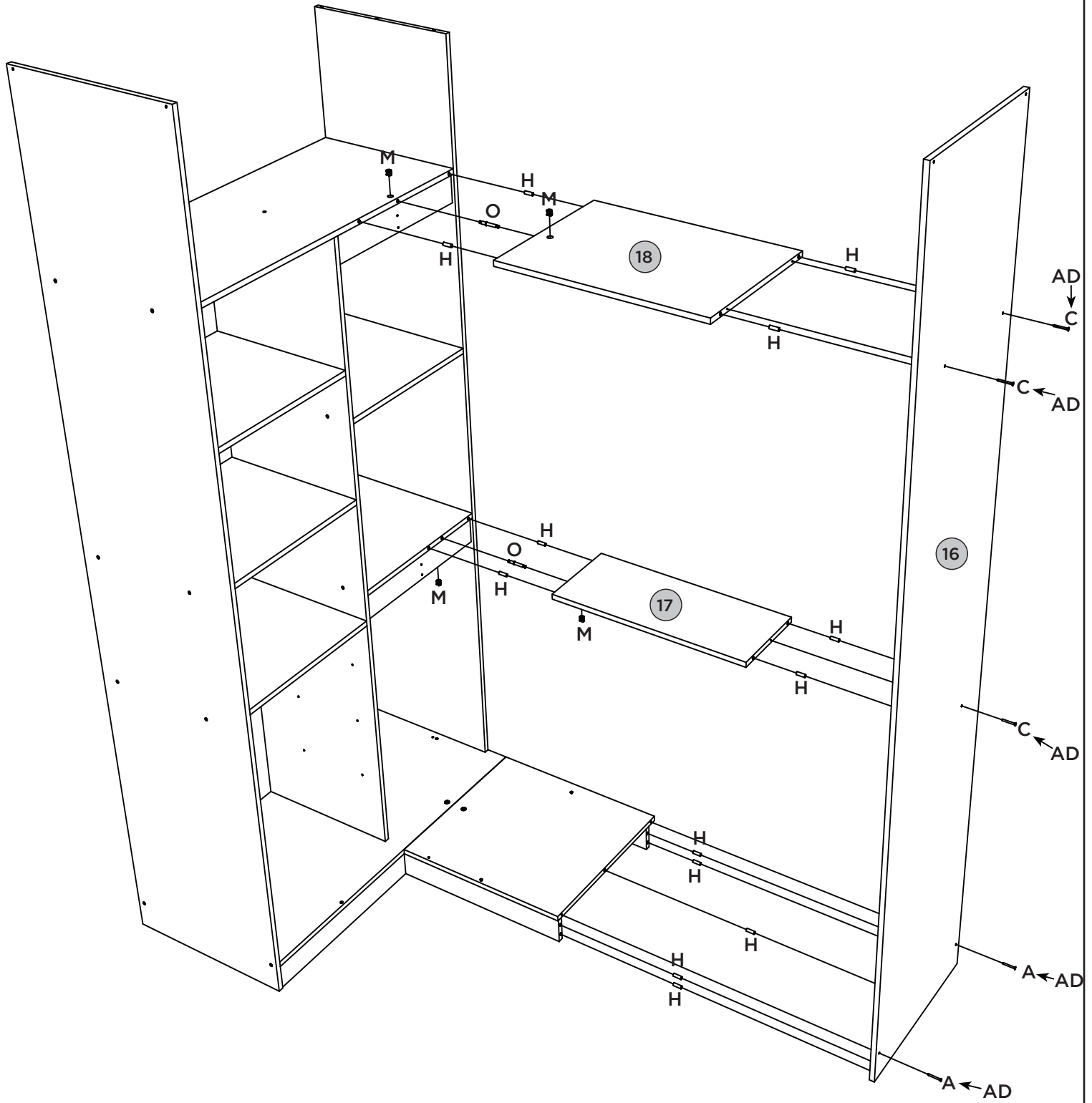

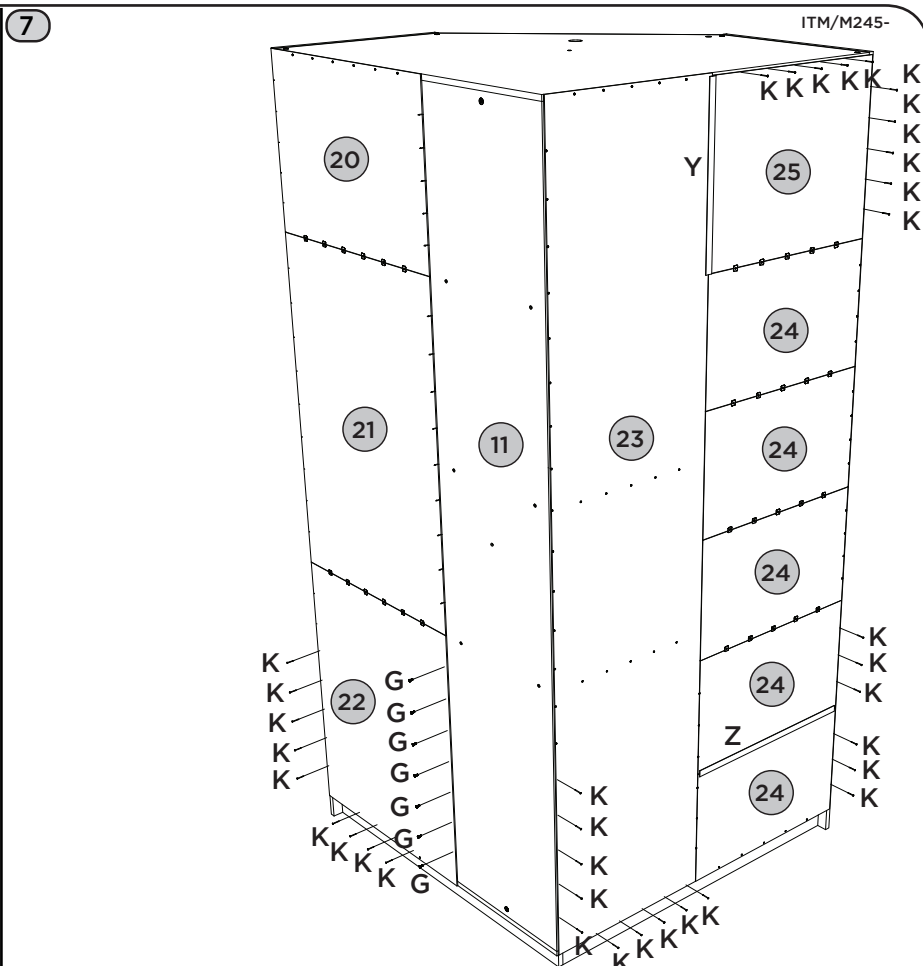
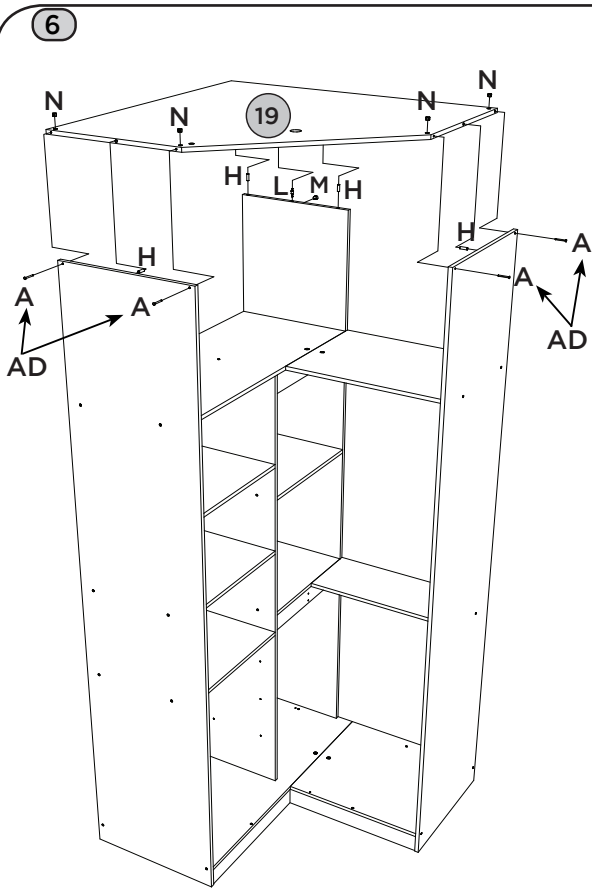

8 Fixação do Kit Led no produto / Fijación Led Kit Producto
 Led Kit fixing on product

- Fixar Interruptor com 2 parafusos 3,5x14 do Kit (Imagem interna)
- Seguro al conmutador con 2 tornillos 3,5x14 Kit (imagen interna)
- Attach Switch with 2 3.5x14 Kit Screws (Internal Image)

IMPORTANTE: Para realizar as conexões dos terminais é necessário utilizar a Instrução que acompanha o Kit.

IMPORTANTE: Para realizar las conexiones de los terminales debe utilizar la instrucción que viene con el kit.

IMPORTANTE: Para realizar as conexões dos terminais é necessário utilizar a Instrução que acompanha o Kit.

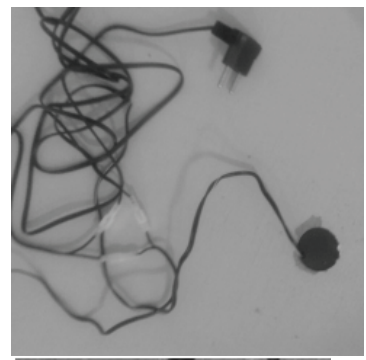
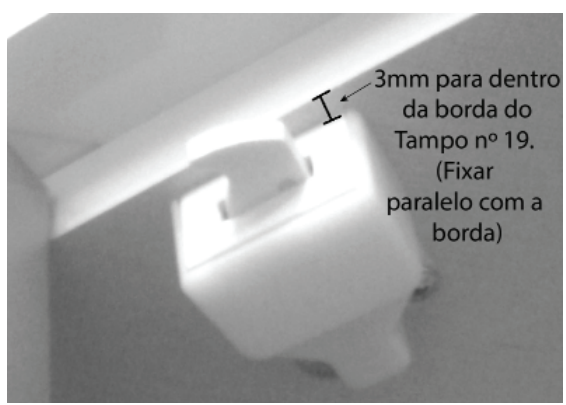
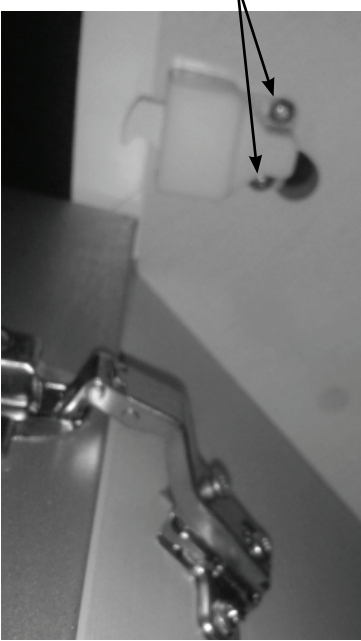

Luminária Led (Imagem interna)

Lâmpara llevada (Imagen interna)

LED Light (Internal Image)

Luminária Led (Vista Superior)

Lâmpara llevada (Vista superior)

Luminária Led (Vista Superior)

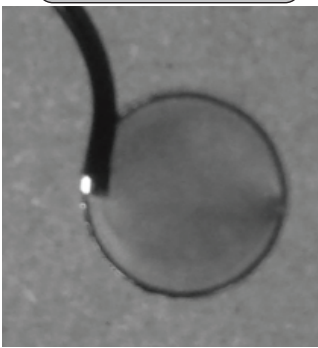
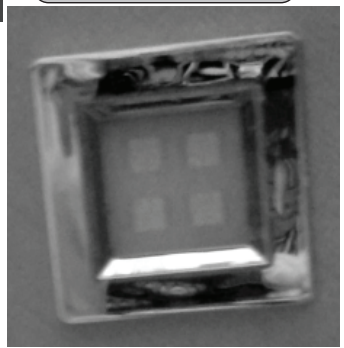
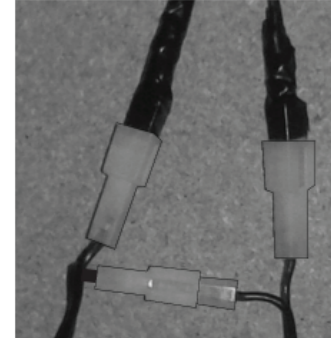

Toda fiação e o plug devem ficar na parte superior do produto

Todo el cableado y el enchufe tienen que estar en la parte superior del producto

All wiring and plug should be on the top of the product

8

Portas vendidas separadamente
 M258-133 Areia HP (Opção 1)
 M258-178 Jequitibá (Opção 1)
 M252-133 Areia HP (Opção 2)
 M252-178 Jequitibá (Opção 2)

Las puertas se venden por separado
 M258-133 Areia HP (Opción 1)
 M258-178 Jequitibá (Opción 1)
 M252-133 Areia HP (Opción 2)
 M252-178 Jequitibá (Opción 2)

Doors sold separately
 M258-133 Areia HP (Option 1)
 M258-178 Jequitibá (Option 1)
 M252-133 Areia HP (Option 2)
 M252-178 Jequitibá (Option 2)

Fazer furação passante para fixar os puxadores, utilizando as pré marcações existentes nas portas.

Taladre agujeros para fijar las manijas, utilizando las marcas previas en las puertas.

Drill through holes to fix the handles, using the pre-markings on the doors.

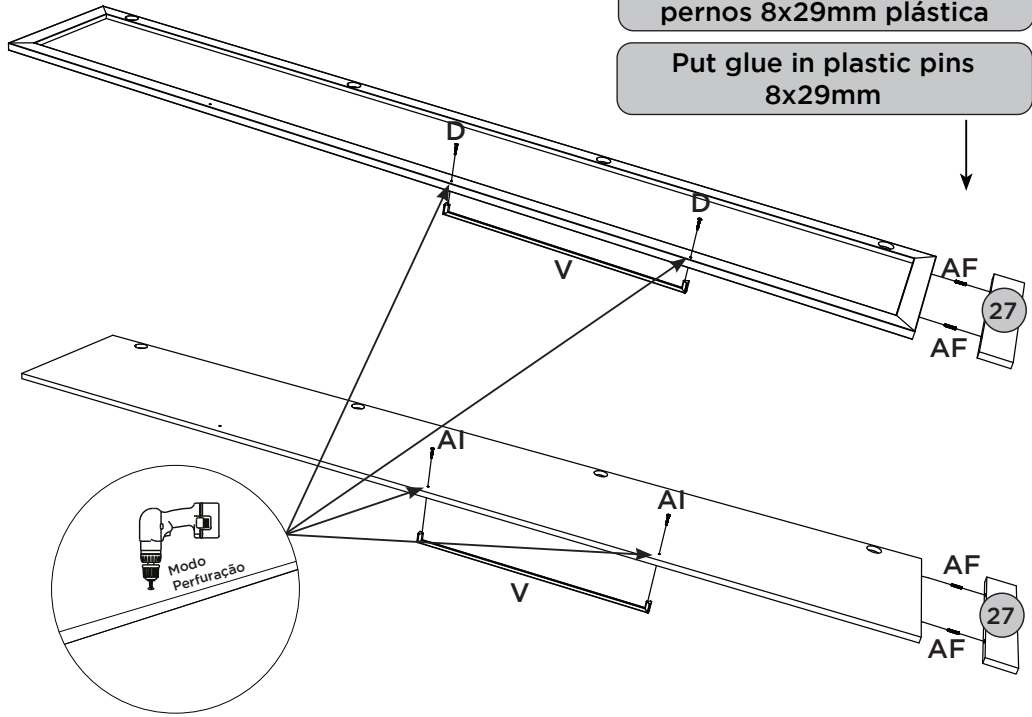

9

Opção 1
 Opción 1
 Option 1

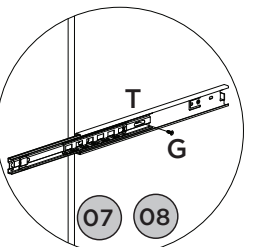
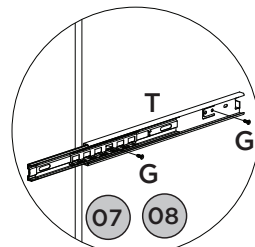
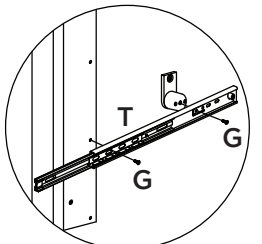
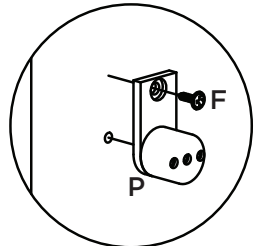
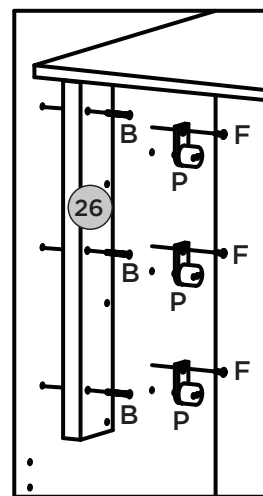
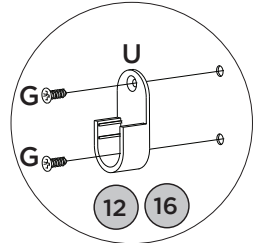
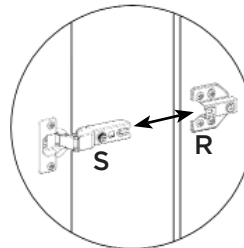
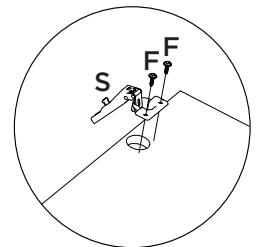
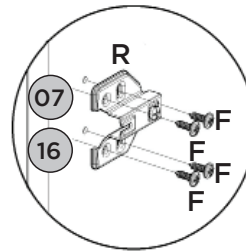
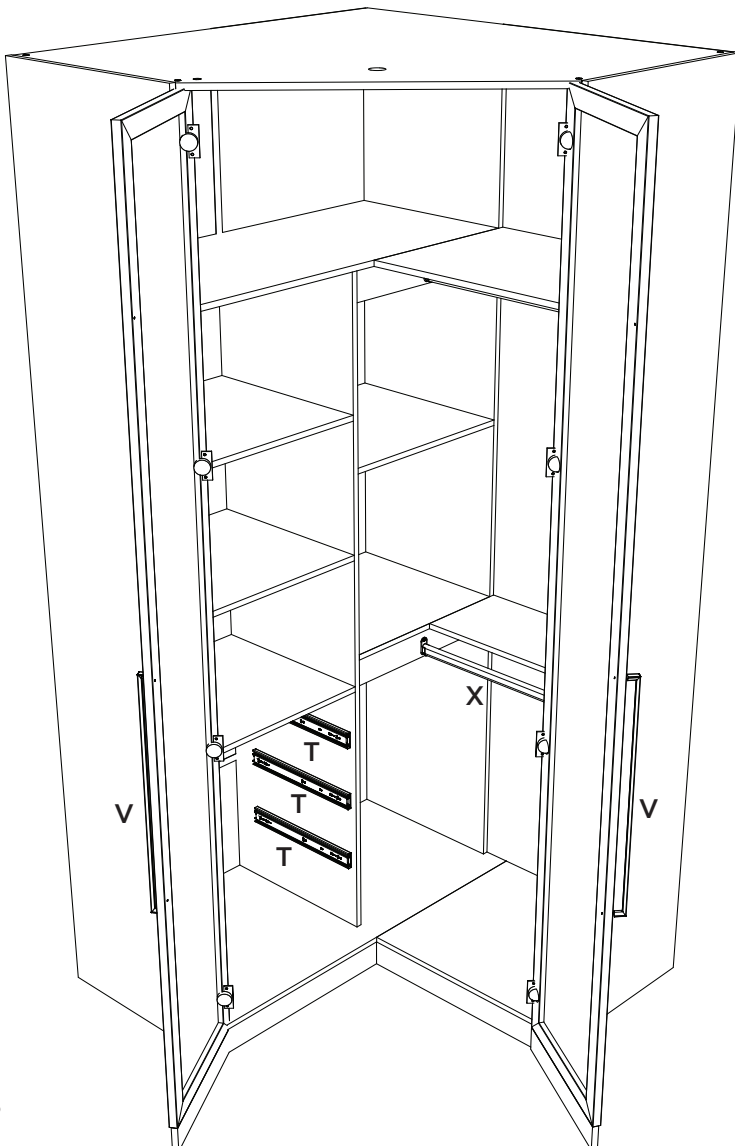

10

Opção 2
Opción 2
Option 2

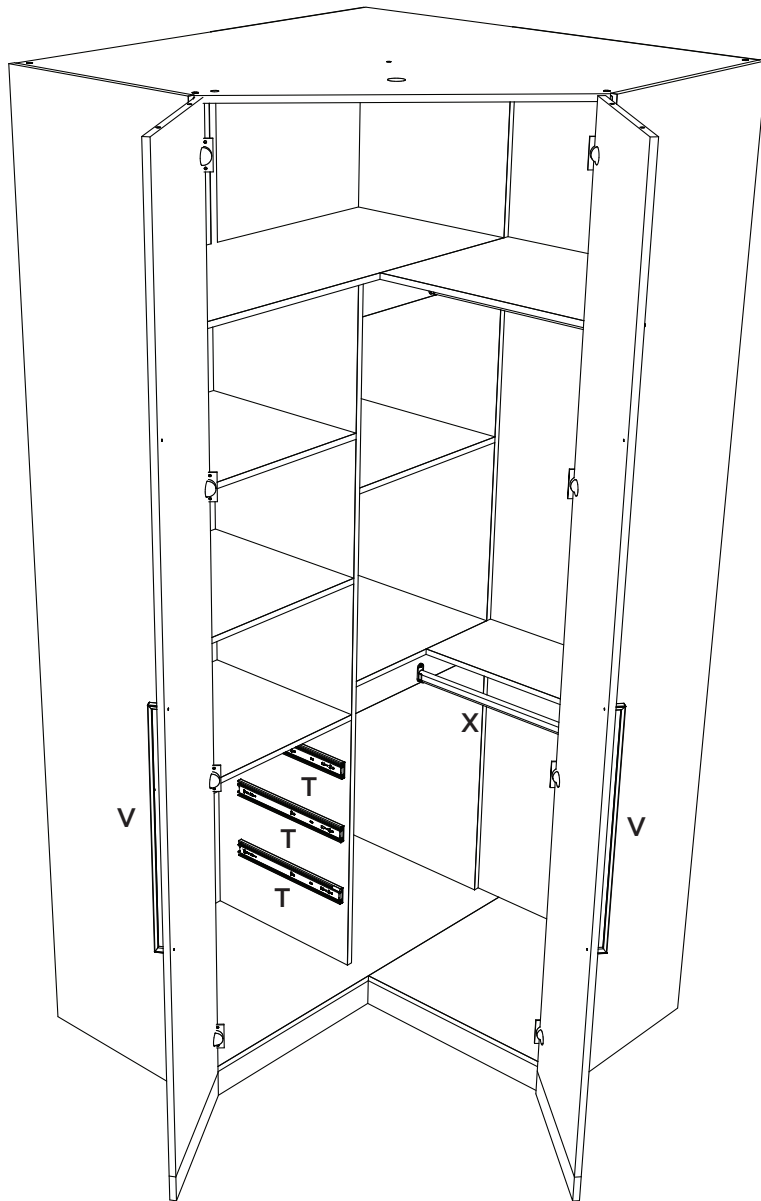

11

ITM/M245-

Montagem gaveta 3x.

Monte cajón 3x.

Mounting drawer 3x.

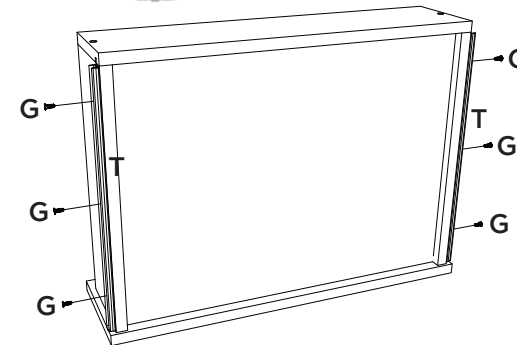
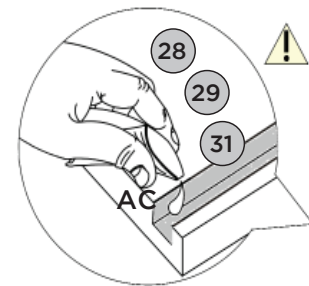
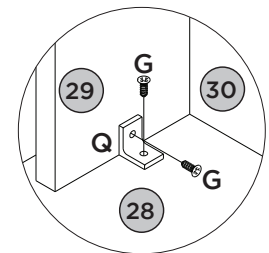
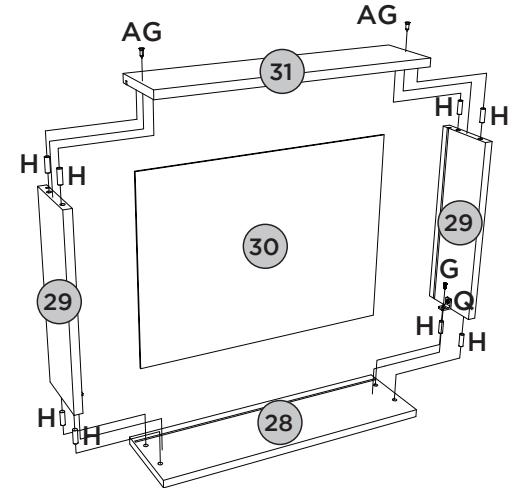

12

A Gaveta Superior é igual as demais gavetas, porém com divisórias.

El Top Drawer es igual también la cajones, pero con separadores.

The Upper Drawer is the same as the other drawers, but with dividers.

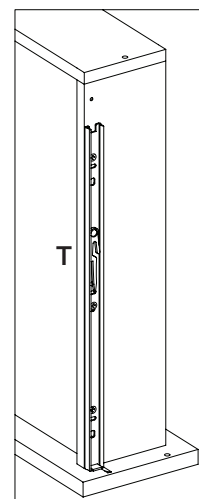
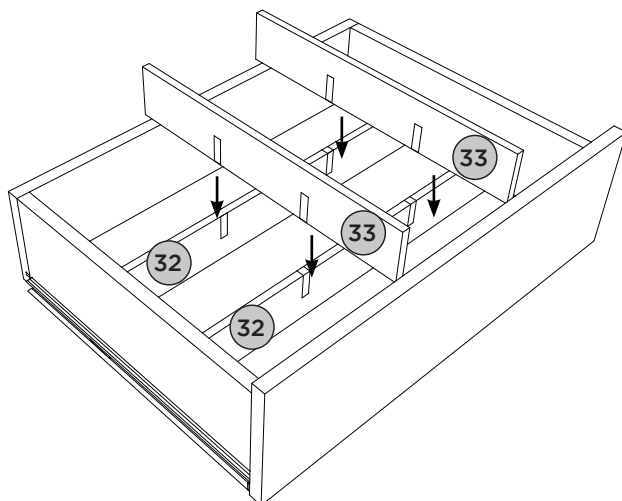















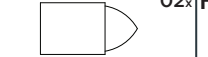

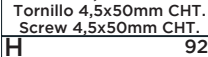
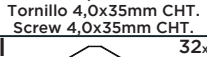
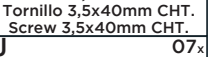
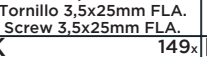
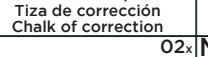
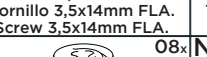

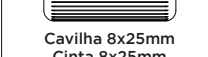
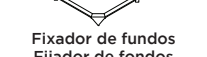

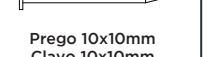
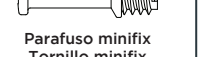
A corredeira (T) deverá ser alinhada com a parte de baixo do lado de gaveta (29)

La corredera (T) debe ser alineada con la parte de por el lado del cajón (29)

The slide (T) should be aligned with the underside of the drawer side (29)

Item	Caixa Caja Box	Qtd Ctd Qty	Descrição Descripción Description	Medidas (mm) Dimensions (mm) Size (measurements) (mm)
01	1/3	01	Rodapé Traseiro Menor Rodapié trasero menor Rear Footer Minor	1028x73x15
02	1/3	01	Rodapé Traseiro Maior Rodapié trasero mayor Larger Back Footer	1043x73x15
03	1/3	01	Rodapé frontal maior Rodapié frontal mayor Larger front footer	1028x73x15
04	1/3	01	Travessa do rodapé Carril pie Baseboard crosspiece	558x73x15
05	1/3	01	Base maior Base mayor Larger base	1075x520x15
06	3/3	01	Base Base Base	555x520x15
07	2/3	01	Lateral esquerda Lateral izquierda Left side	2400x520x15
08	2/3	01	Divisão División Division	1807x450x15
09	1/3	01	Tampo das gavetas Tapa de los cajones Drawer top	555x450x15
10	3/3	02	Prateleira fixa Estante fija Fixed shelf	555x450x15
11	2/3	01	Fundo 15mm Fondo 15mm 15mm Bottom	2296x450x15
12	1/3	02	Travessa sustentação Apoyo travesaño Support rail	490x80x15
13	1/3	01	Prateleira Menor Estante menor Minor shelf	490x450x15
14	1/3	01	Prateleira menor central Estante inferior centro Central Smallest Shelf	490x450x15
15	1/3	01	Prateleira maior Estante mayor Largest shelf	1060x450x15
16	2/3	01	Lateral direita Lateral derecha Right side	2400x520x15
17	3/3	01	Prateleira do calceiro Estante del calzón Shelf calceiro	625x250x15
18	3/3	01	Prateleira superior direita Estante superior derecha Right upper shelf	625x450x15
19	3/3	01	Tampo superior Tapa superior Top panel	1075x1075x15
20	3/3	01	Fundo Superior Fondo superior Superior background	652x496x3
21	3/3	01	Fundo central Fondo central Central fund	1007x652x3
22	3/3	01	Fundo Inferior Fondo inferior bottom background	821x652x3
23	2/3	01	Fundo maior Fondo mayor Larger background	2324x507x3
24	3/3	05	Fundo Fondo Bottom	572x365x3
25	1/3	01	Fundo menor superior Fondo inferior superior Top lower bottom	572x489x3
26	1/3	01	Ripa lateral Listón lateral Ripa side	530x80x25
27	1/3	02	Moldura frontal inferior Cornija frontal inferior Bottom front bezel	391x68x15
28	3/3	03	Frente de gaveta Frente de cajón Front of drawer	522x152x15
29	3/3	06	Lado de gaveta Lado del cajón Side of drawer	350x122x15
30	3/3	03	Fundo de gaveta recortado Fondo de cajón recortado Drawer bottom trimmed	486x361x3
31	1/3	03	Ripa de trás Malla detrás Rear lath	505x122x15
32	3/3	02	Divisória Maior Divisoria Mayor Greater Divisory	474x60x9
33	3/3	02	Divisória Menor División Menor Small Partition	349x60x9

Ferragens | Herrajes | Hardware

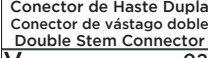
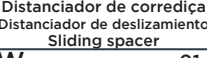
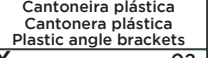
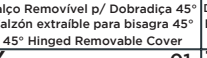
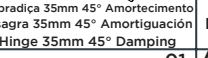
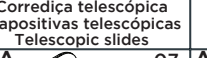
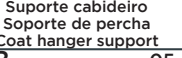
A  Parafuso 4,5x50mm CHT. Tornillo 4,5x50mm CHT. Screw 4,5x50mm CHT.	B  Parafuso 4,0x35mm CHT. Tornillo 4,0x35mm CHT. Screw 4,0x35mm CHT.	C  Parafuso 3,5x40mm CHT. Tornillo 3,5x40mm CHT. Screw 3,5x40mm CHT.	D  Parafuso 3,5x25mm FLA. Tornillo 3,5x25mm FLA. Screw 3,5x25mm FLA.	E  Giz de correção Tiza de corrección Chalk of correction	F  Parafuso 3,5x14mm FLA. Tornillo 3,5x14mm FLA. Screw 3,5x14mm FLA.	G  Parafuso 3,5x12mm CHT. Tornillo 3,5x12mm CHT. Screw 3,5x12mm CHT.
H  Cavilha 8x25mm Cinta 8x25mm Dowel 8x25mm	I  Fixador de fundos Fijador de fondos Bottom fixer	J  Prego 12x12mm Anelado Clavo 12x12mm Anillado Ringed Nails 12x12mm	K  Prego 10x10mm Clavo 10x10mm Nail 10x10mm	L  Parafuso minifix Tornillo minifix Minifix bolt	M  Tambor minifix Tambor minifix Minifix drum	N  Porca cilíndrica Tuerca cilíndrica Cylindrical nut
O  Conector de Haste Dupla Conector de vástago doble Double Stem Connector	P  Distanciador de corredeira Distanciador de deslizamiento Sliding spacer	Q  Cantoneira plástica Cantонера plástica Plastic angle brackets	R  Calço Removível p/ Dobradilha 45° Calzón extraíble para bisagra 45° 45° Hinged Removable Cover	S  Dobradilha 35mm 45° Amortecimento Bisagra 35mm 45° Amortiguación Hinge 35mm 45° Damping	T  Corredeira telescópica Diapositivas telescópicas Telescopic slides	U  Suporte cabideiro Soporte de percha Coat hanger support
V  Puxador Aleno Fit Alumínio Mango de alumínio Aleno Fit Aleno Fit Aluminum Handle	W  Kit Led Kit Led Led Kit	X  Cabideiro Alum. 628mm Alum. 628mm percha Alum. coat hanger 628mm	Y  Perfil "I" 489mm Perfil "I" 489mm Profile "I" 489mm	Z  Perfil "I" 560mm Perfil "I" 560mm Profile "I" 560mm	AA  Sapata "L" 16x20mm Zapata "L" 16x20mm "L" shoe 16x20mm	AB  Parafuso União Metal Tornillo Unión Metal Metal Union Screw
AC  Sachê de cola Bolsa de pegamento Glue bag	AD  Adesivo tampa parafuso 10mm Adhesivo tapón de tornillo 10mm Bolt cover adhesive 10mm	AE  Adesivo tampa parafuso 17mm Adhesivo tapón de tornillo 17mm Bolt cover adhesive 17mm	AF  Cavilha Plástica 8x29mm Cinta Plástico 8x29mm Plastic Dowel 8x29mm	AG  Parafuso 3,0x30mm CHT. Tornillo 3,0x30mm CHT. Screw 3,0x30mm CHT.	AH  Etiqueta resinada Henn Etiqueta resinada Henn Henn resin label	AI  Parafuso 3,5x22mm CHT. Tornillo 3,5x22mm CHT. Screw 3,5x22mm CHT.