

KAIKI

MÓVEIS

KAIKI MÓVEIS INDÚSTRIA E COMÉRCIO LTDA.

Av. Raul Alves Ferreira, 311 - Centro - Fone/Fax (32) 3577-1198
 CEP 36510-000 - Rodeiro - MG
 vendas@kaikimoveis.com.br



Balcão ATENAS 4 Pts. Ref.: 1898

Sr. Montador, caso haja assistência, anotar número da peça, nome e cor, passe para a pessoa responsável, para que possamos atendê-lo o mais rápido possível.

COMPONENTES

1 - BASE	09 - PORTA
2 - PÉ	10 - COSTAS
3 - LATERAL ESQUERDA	11 - PERFIL H
4 - DIVISÃO PRATELEIRA	12 - FRENTE GAVETA
5 - PRATELEIRA	13 - LATERAL GAVETA
6 - LATERAL DIREITA	14 - TRASEIRO GAVETA
7 - TRAVESSA MAIOR	15 - FUNDO GAVETA
8 - TAMPO	16 - COSTAS VERTICAL

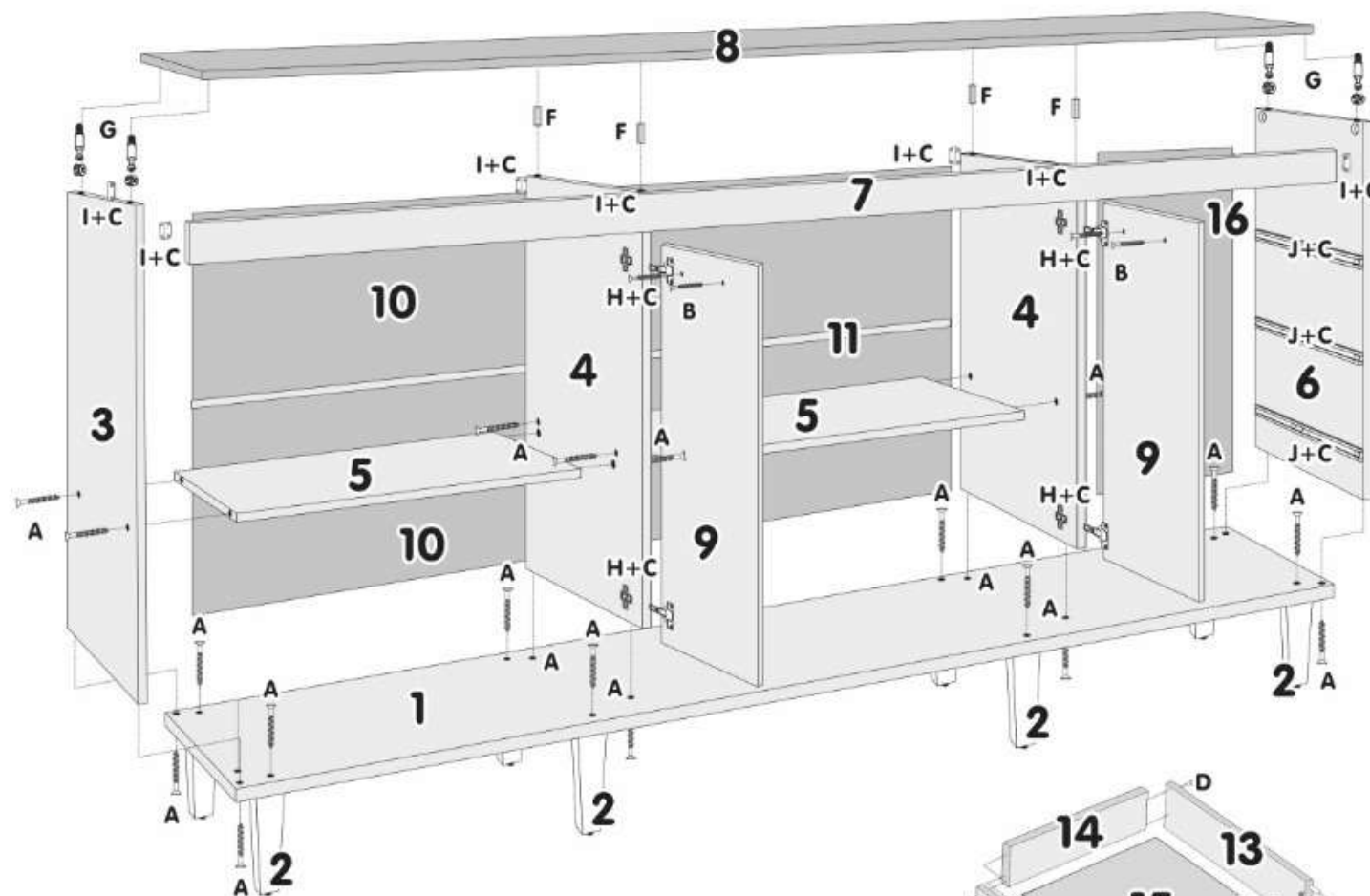

**ATENÇÃO: AS COSTAS E FUNDO DA GAVETA
SÃO FIXADOS COM PREGOS 10x10.**

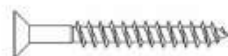
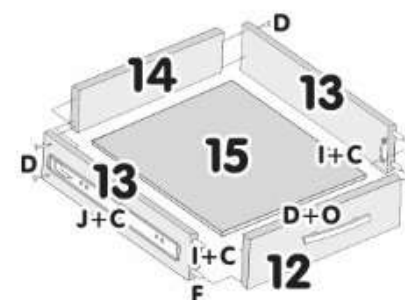

A - Paraf. 5x40

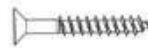

B - Paraf. 4x25



C - Paraf. 3,5x14



D - Prego 13x15



E - Prego 10x10



F - Cavilha 6x30



G - Minifix



H - Dobradiça de Pressão



I - Cantoneira 4 Furos



J - Corrediça Telescópica



K - Puxador

KAIKI

MÓVEIS

KAIKI MÓVEIS INDÚSTRIA E COMÉRCIO LTDA.

Av. Raul Alves Ferreira, 311 - Centro - Fone/Fax (32) 3577-1198
CEP 36510-000 - Rodeiro - MG
vendas@kaikimoveis.com.br

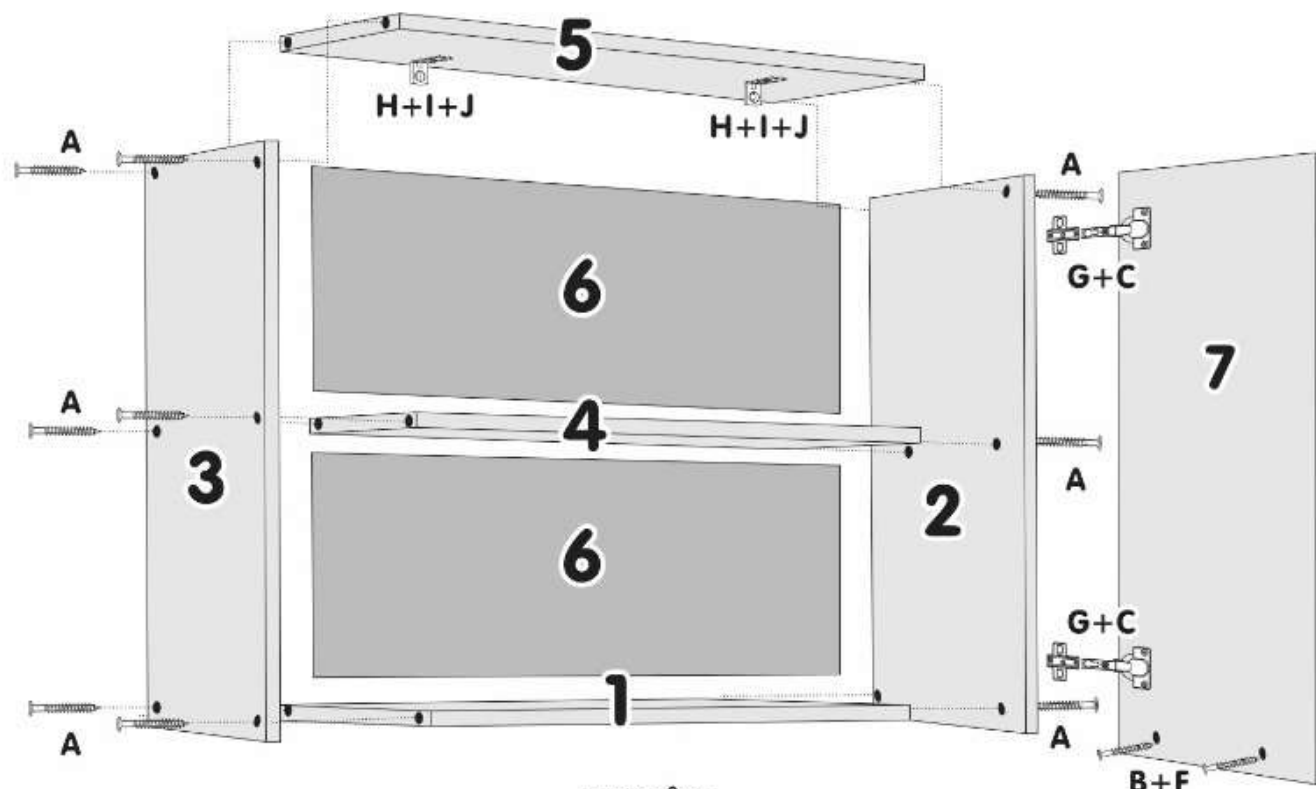

Armário Aéreo VALENCIA - Ref.: 1776

ATENÇÃO:

AS COSTAS SÃO FIXADAS COM PREGOS 10x10.

SR. MONTADOR, CASO HAJA ASSISTÊNCIA, ANOTAR NÚMERO DA PEÇA, NOME E COR, PASSE PARA A PESSOA RESPONSÁVEL, PARA QUE POSSAMOS ATENDÊ-LO O MAIS RÁPIDO POSSÍVEL.

COMPONENTES

- 1 - BASE
- 2 - LATERAL DIREITA
- 3 - LATERAL ESQUERDA
- 4 - PRATELEIRA
- 5 - TAMPO
- 6 - COSTAS
- 7 - PORTA

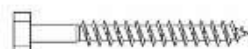

A - Paraf. 5x50 Sextavado



D - Prego 10x10

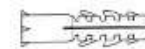

H - Bucha

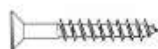

B - Paraf. 4x25



F - Puxador

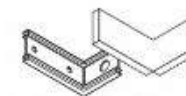

I - Cantoneira Parede



C - Paraf. 3,5x14



G - Dobradiça de Pressão

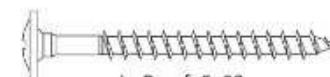

J - Paraf. 6x60



FAÇA A LEITURA E
ASSISTA AO VÍDEO
DA MONTAGEM



Armário Aéreo ETIOS - Ref.: 1285

COMPONENTES

1 - BASE	10 - COSTAS
2 - PÉ	11 - PERFIL H
3 - LATERAL ESQUERDA	12 - FRENTE GAVETA
4 - DIVISÃO PRATELEIRA	13 - LATERAL GAVETA
5 - PRATELEIRA	14 - TRASEIRO GAVETA
6 - LATERAL DIREITA	15 - FUNDO GAVETA
7 - TRAVESSA MAIOR	16 - COSTAS
8 - TAMPO	17 - PERFIL H
9 - PORTA	

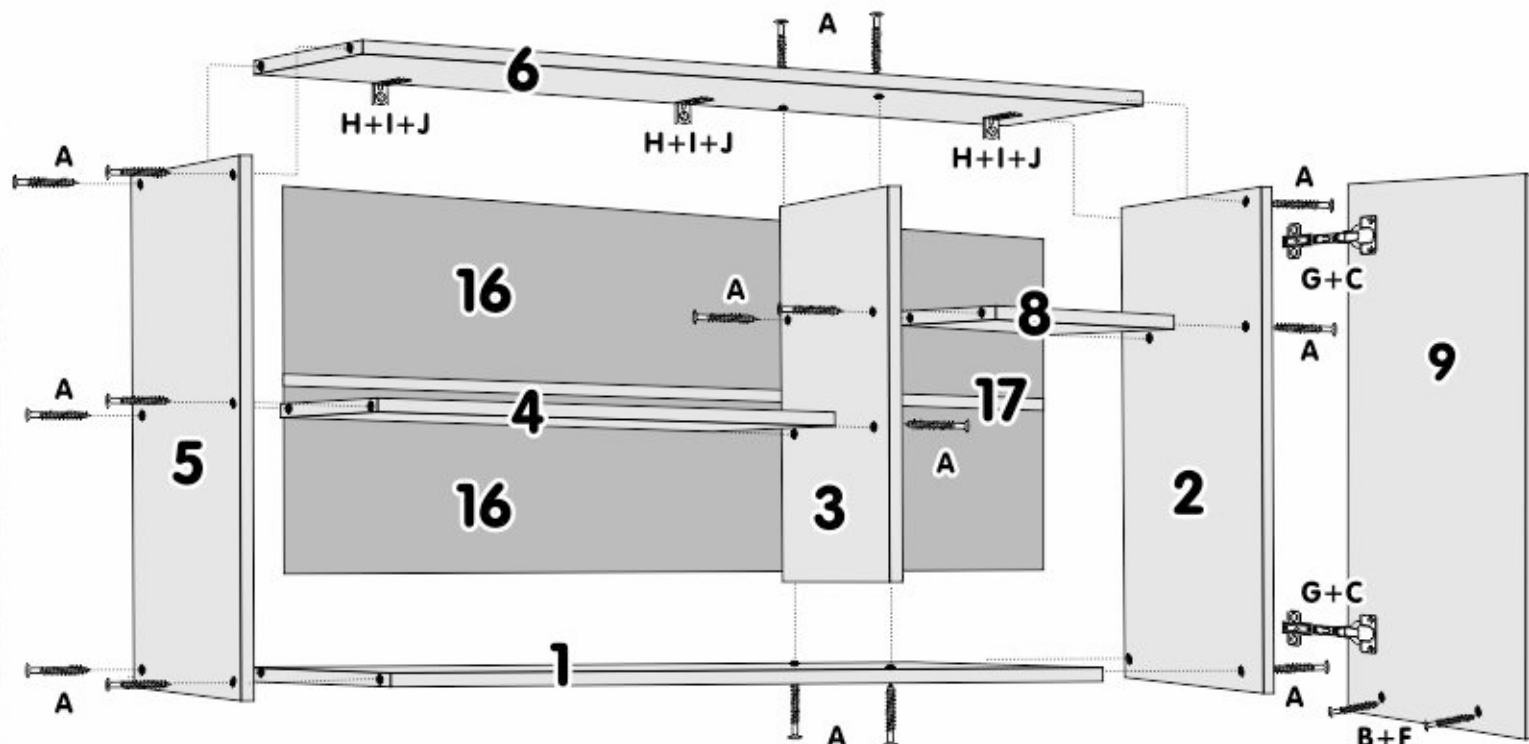

ATENÇÃO:
AS COSTAS É FIXADA COM PREGOS 10x10.

SR. MONTADOR, CASO HAJA ASSISTÊNCIA, ANOTAR NÚMERO DA PEÇA, NOME E COR, PASSE PARA A PESSOA RESPONSÁVEL, PARA QUE POSSAMOS ATENDÊ-LO O MAIS RÁPIDO POSSÍVEL.

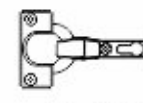
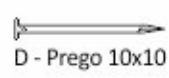
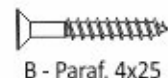
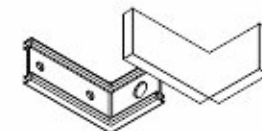
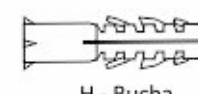

Agora que você já comprou o seu móvel, ele merece ser montado do jeito certo.

Erros de montagem causam mais de **60%** dos danos em móveis.

Por que contratar?

Tranquilidade do **início ao fim** da montagem



PROFISSIONAIS QUALIFICADOS

Especialistas certificados na **MadeiraMadeira Serviços**.



FERRAMENTAS PROFISSIONAIS

que **protegem** seus móveis.



AGENDAMENTO EM 24 HORAS

escolha a data e o turno **ideais para** você.



GARANTIA DE 3 MESES

de cobertura **completa**.

Mais de 1 MILHÃO DE MONTAGENS
★ com avaliação **4.7** ★

Mariana S., São Paulo

"Chegaram no horário e montaram tudo rapidamente. Serviço incrível!"



Carlos R., Belo Horizonte

"Tentei montar sozinho e foi um desastre. Com a **MadeiraMadeira Serviços** ficou perfeito."



Ana P., Rio de Janeiro

"Agendamento ágil e **montagem pontual e perfeita**. Recomendo demais!"



Agende agora pelo
QR Code

Madeira**Madeira** Serviços · Atendimento em todo o Brasil



Escaneie o QRCode