

Ref.8500

Alt.780 Larg. 1120 Prof.450 mm de MDP BP

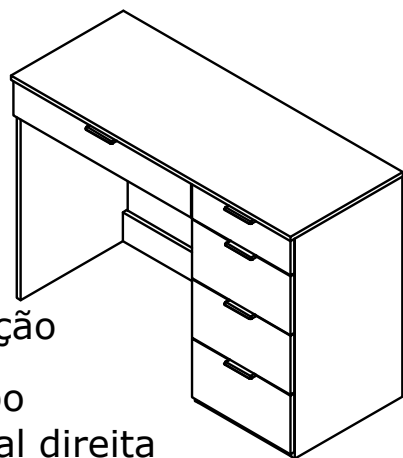







Penteadeira  
sem espelho

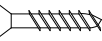
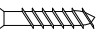
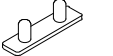

Ordem N° Descrição

- |    |       |                            |
|----|-------|----------------------------|
| 1  | 15382 | Tampo                      |
| 2  | 15354 | Lateral direita            |
| 3  | 15369 | Rodapés                    |
| 4  | 15356 | Divisória                  |
| 5  | 15357 | Colunas traseiras          |
| 6  | 15355 | Lateral esquerda           |
| 7  | 15374 | Fundo                      |
| 8  | 15358 | Afastador de gaveta        |
| 9  | 15364 | Traseiro de gaveta         |
| 10 | 15363 | Lateral de gaveta esquerda |
| 11 | 15362 | Lateral de gaveta direita  |
| 12 | 15372 | Fundo de gaveta            |
| 13 | 15359 | Frente de gaveta           |
| 14 | 15367 | Traseiro de gaveta         |
| 15 | 15366 | Lateral de gaveta esquerda |
| 16 | 15365 | Lateral de gaveta direita  |
| 17 | 15372 | Fundo de gaveta            |
| 17 | 15360 | Frente de gaveta           |
| 19 | 15368 | Traseiro de gaveta         |
| 20 | 15366 | Lateral de gaveta esquerda |
| 21 | 15365 | Lateral de gaveta direita  |
| 22 | 15373 | Fundo de gaveta            |
| 23 | 15361 | Frente de gaveta           |

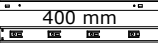
### Ferragem

A	 Cavilha 8 x 30 mm	58
B	 Minifix 6 x 32 mm	24
C	 Tambor 15 x 15 mm	24
D	 Tampa Adesiva 19 mm	24
E	 Parafuso 3,5 x 14 CC	65
F	 Parafuso 4 x 25 cc	03
G	 Parafuso 3,5 x 35 cc	10
H	 Sapata 15 x 60 mm	06
I	 Pregos 10 x 10mm	25
J	 Trilho telescópico 400mm	05
K	 Puxador BALY 108mm	05

