

**Estante para livros 5
nichos Montreal**

Informações Utéis

Para assegurar a garantia, é recomendada a prévia conferência das peças e componentes, bem como a leitura do manual de montagem.

Qualquer dúvida sobre os nossos produtos você pode entrar em contato via nosso canal de atendimento:

Limpeza

- Para começar a limpeza, retire o pó com flanela seca, depois use um pano macio, levemente umedecido com água. É possível o uso de detergente neutro, ou sabão neutro com água;
- De tempos em tempos, reaperte os parafusos do produto para garantir sua estabilidade e durabilidade;
- Tenha cuidado com a disposição de aparelhos eletrônicos sobre o móvel, a falta de ventilação e excesso de calor podem prejudicar a durabilidade e acabamento do seu produto.

Para mais dicas amigáveis e inspirações de decoração acesse nosso blog:
<https://www.madeiramadeira.com.br/central-de-dicas>

Siga MadeiraMadeira:



madeiramadeira.com.br



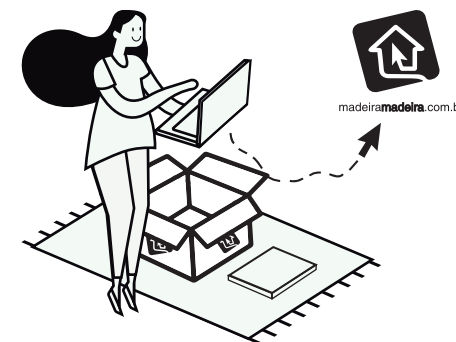
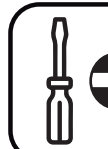
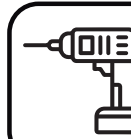
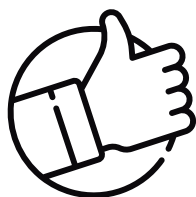
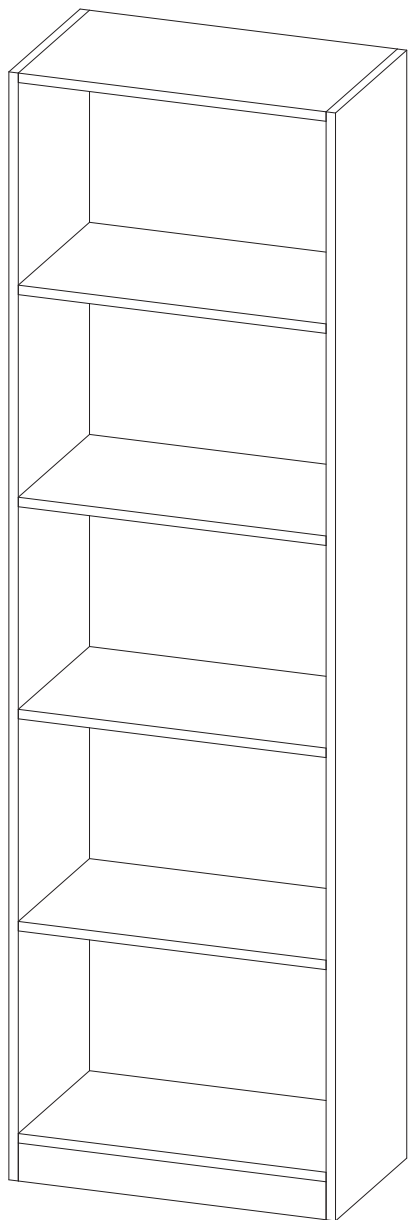

madeiramadeira.com.br

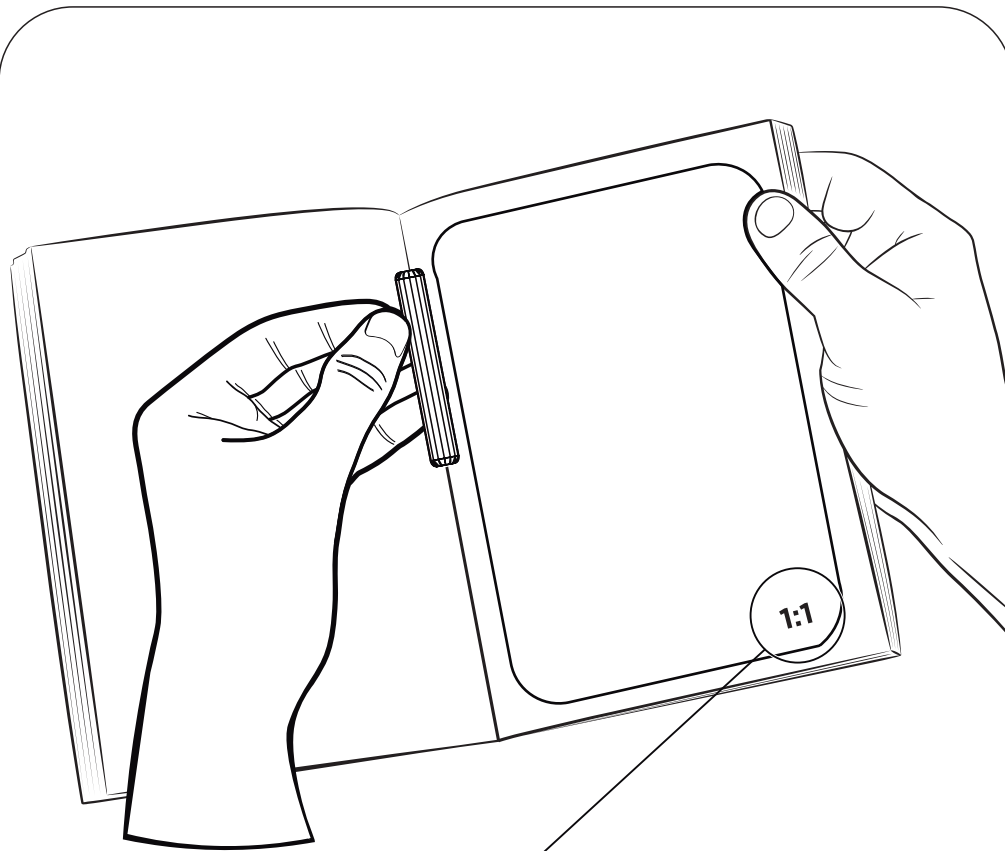

Preste Atenção!

As ferragens dos nossos manuais são sempre apresentadas nas mesmas proporções da peça na vida real. Caso apareça alguma dúvida no decorrer do processo de montagem, coloque a ferragem ao lado do desenho e faça a consulta :D



Símbolos:

- + Parafuso Phillips
- Parafuso Fenda
- ⬡ Parafuso Allen

5

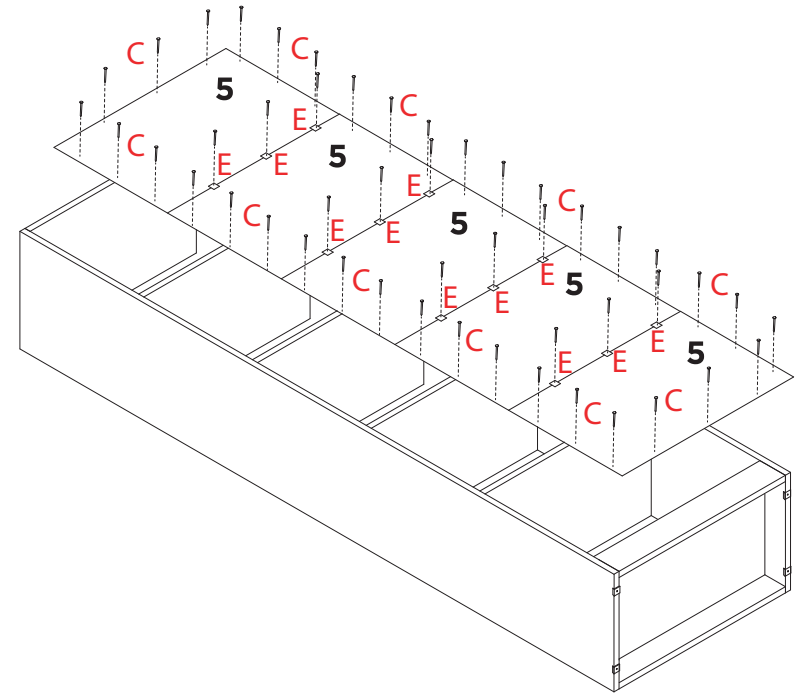

6

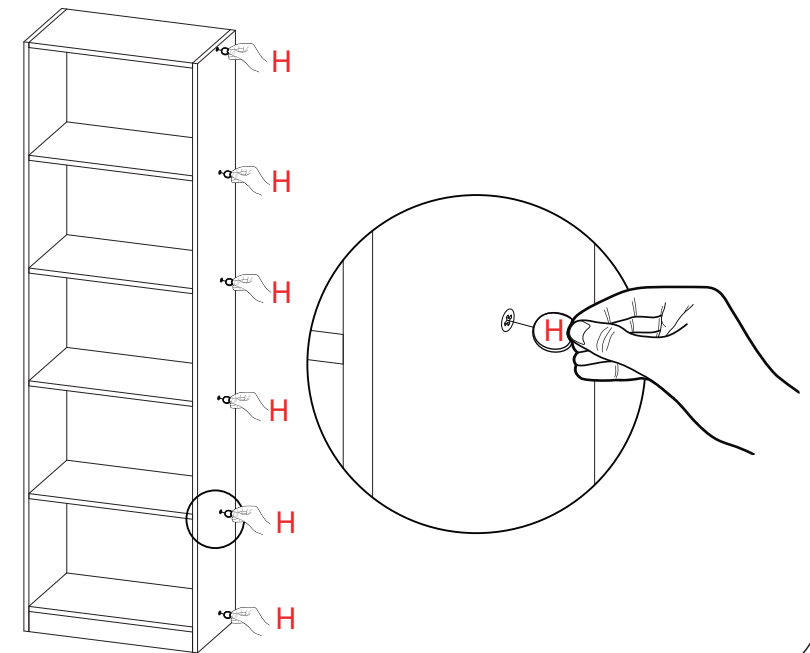

3

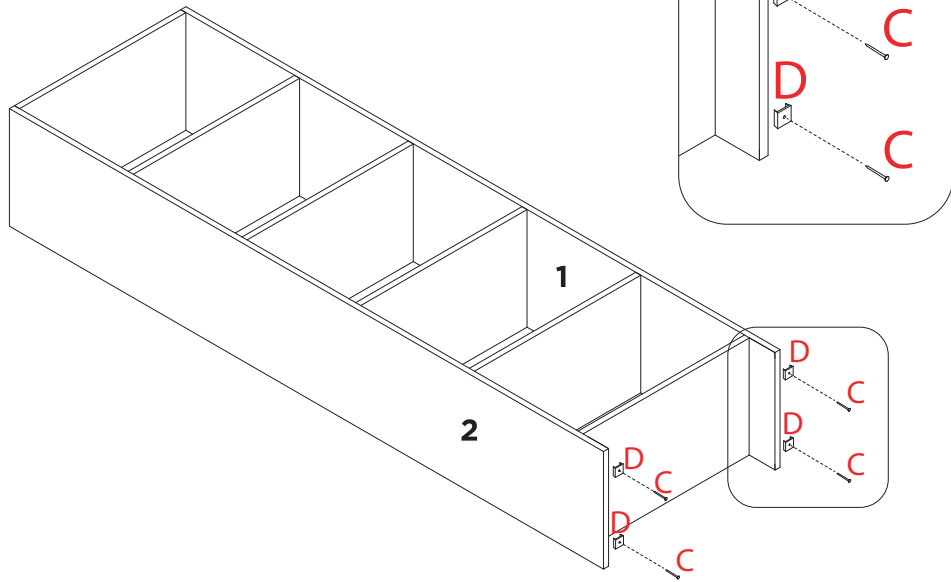

4

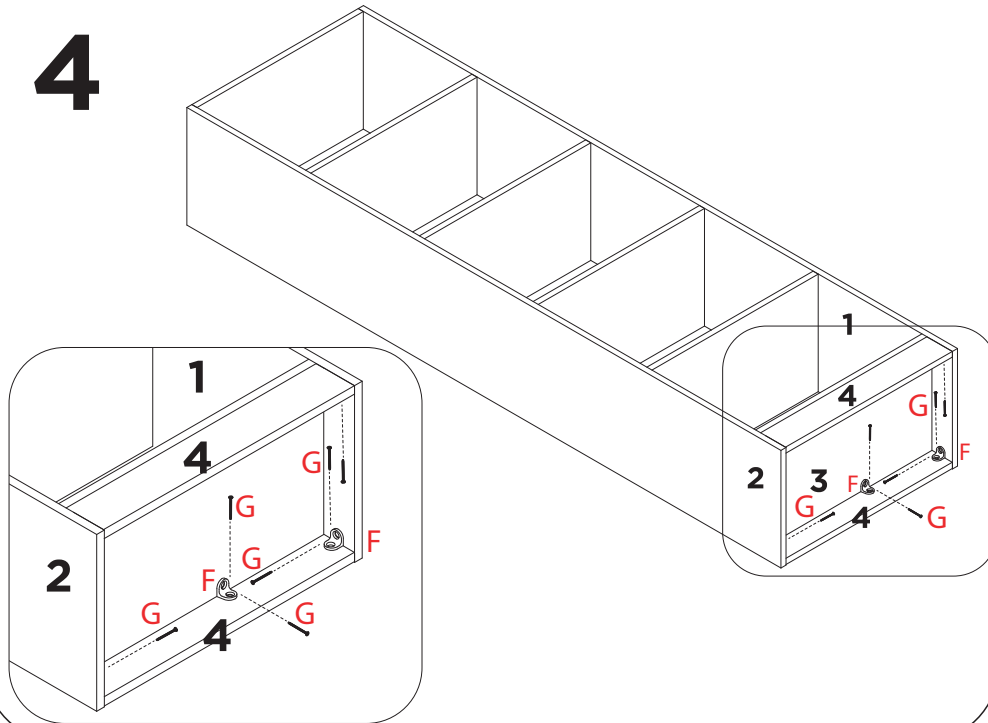

PRATELEIRAS
Suporta até 7 kg
por prateleira

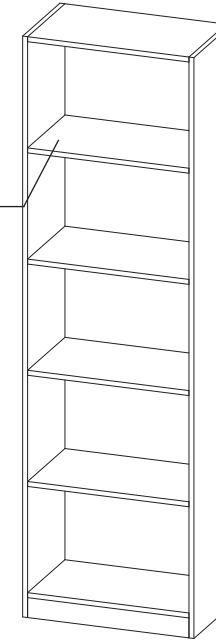

TAMANHO ESCALA
REAL PARAFUSOS

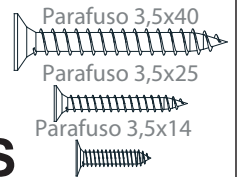

LISTA DE FERRAGENS

Nº PEÇA	PEÇA	DESCRIÇÃO	QTD	CÓDIGO DE FERRAGENS
A		Cavilha 6X30 mm	24 un.	063019
B		Parafuso 3,5 x 40	12 un.	354019
C		Pregos	52 un.	101019
D		Sapata 15x15	4 un.	1515B19
E		Fixador fundo	12 un.	6619
F		Cantoneira	6 un.	32619
G		Parafuso 3,5 x 14	12 un.	351419
H		Tapa Furo	12 un.	206B19

LISTA DE PEÇAS

Nº PEÇA	DESCRIÇÃO	QTD	DIMENSÕES (mm)			PESO UNT (KG)	CÓDIGO DE REFERÊNCIA
			COMP.	LARG.	ESP.		
1	LATERAL DIREITA	01	1750	300	15	5,15	51251311601
2	LATERAL ESQUERDA	01	1750	300	15	5,15	51251311602
3	PRATELEIRAS	06	490	300	15	1,45	51251311603
4	RODA PÉ	02	490	60	15	0,3	51251311604
5	FUNDOS 3MM	05	510	334	3	0,57	51251311605

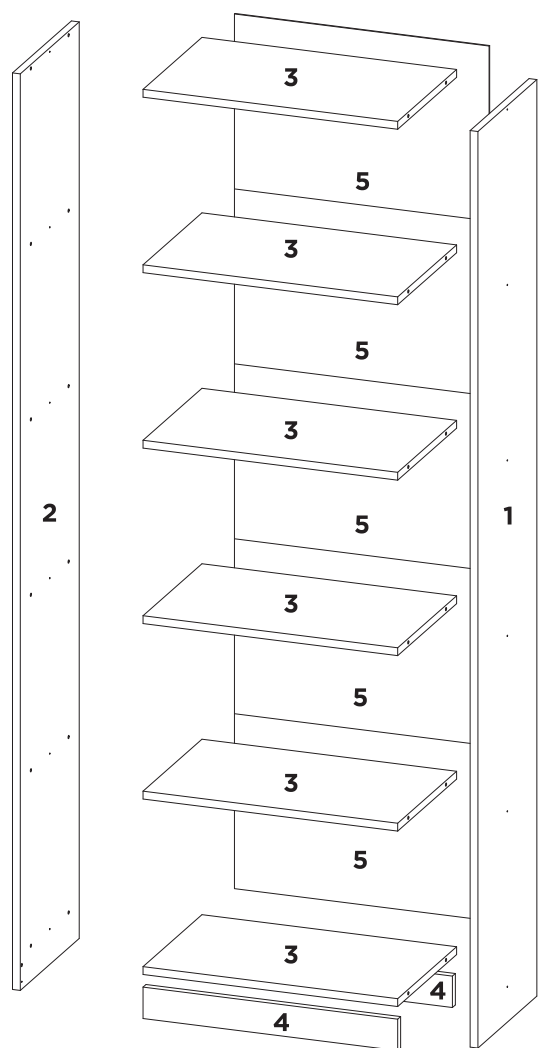

1

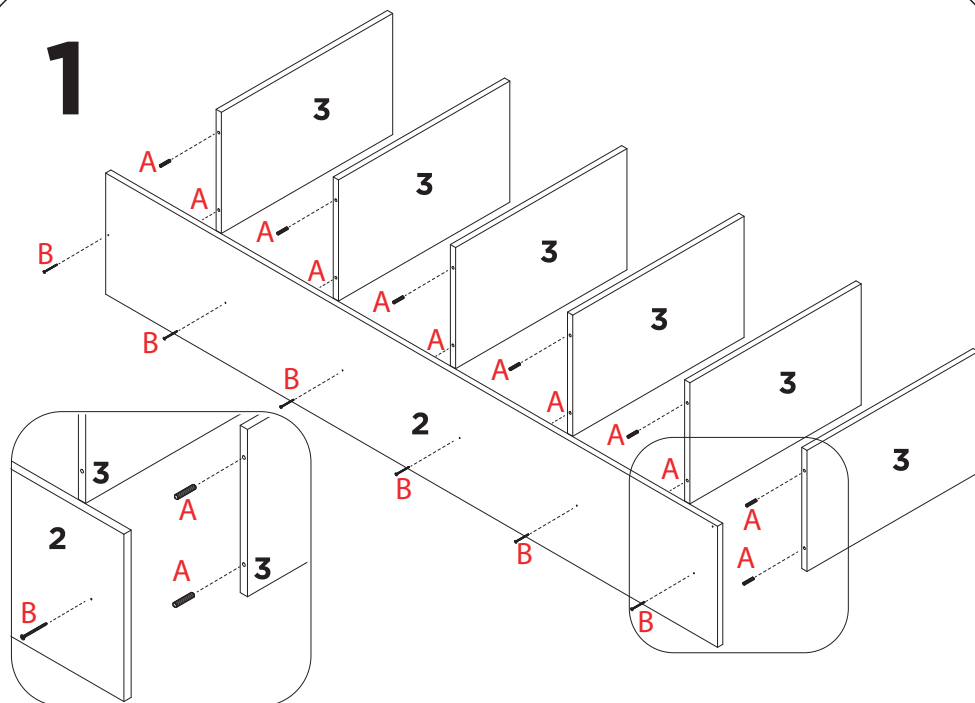

2

