

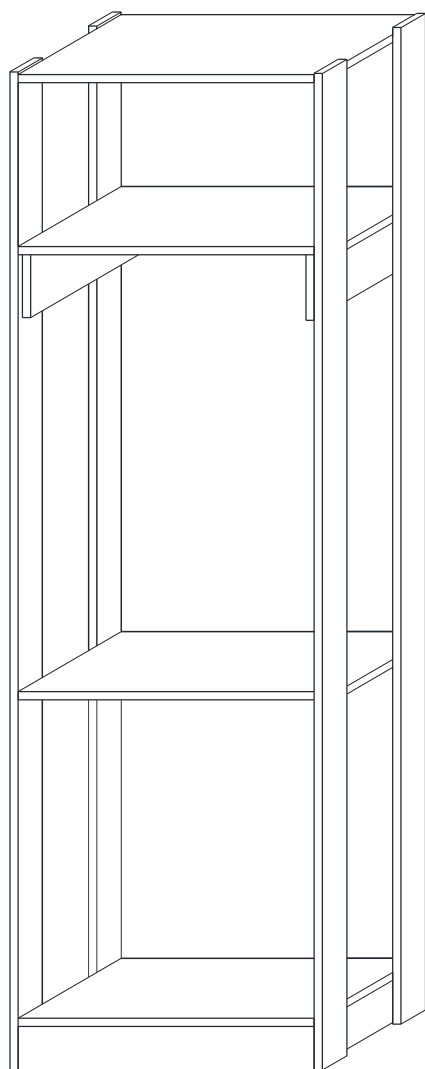

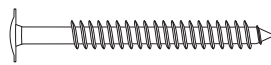







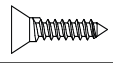
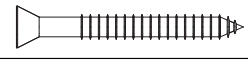

## Modulo TITAN

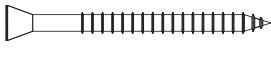

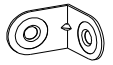
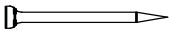
Nº PÇ	Descrição das peças	Qt.
1	Lateral Esquerda e Direita Frente	02
2	Base	01
3	Rodapé frontal	01
4	Rodapé Lateral	02
5	Tampo Inferior	01
6	Tampo Superior	01
7	Apoio do cabideiro	02
8	Chapéu	01
9	Lateral Esquerda e Direita Costa	02

	DESCRIÇÃO	QTD
<b>A</b>	 Parafuso 4,0 x 40	16
<b>B</b>	 Porca cilíndrica 9 x 12	16
<b>C</b>	 Parafuso 3,5 x 12	08
<b>D</b>	 Parafuso 4,0 x 25	12
<b>E</b>	 Cavilha 06 x 30	12
<b>F</b>	 Suporte Cabideiro Oblongo	02
<b>G</b>	 Cabideiro	01
<b>H</b>	 Parafuso 3,5 x 40	04
<b>I</b>	 Etiqueta	01
<b>J</b>	 Cantoneira	02
<b>K</b>	 Pregos 08 x 08	04
<b>L</b>	 Sapata 15mm	04
<b>M</b>	 Tapa adesiva	04
<b>N</b>	 Giz de Correção	02

### PARA A LIMPEZA E CONSERVAÇÃO DO SEU MÓVEL

- Não use produtos abrasivos como Álcool, Solventes, Acetona e etc...
- Use somente um pano macio e seco.

### DESEMBALANDO

Identifique todas as peças e deixe-as de pé, nunca coloque umas sobre as outras. Utilize a própria embalagem como tapete para a montagem do produto.

### Passo 01

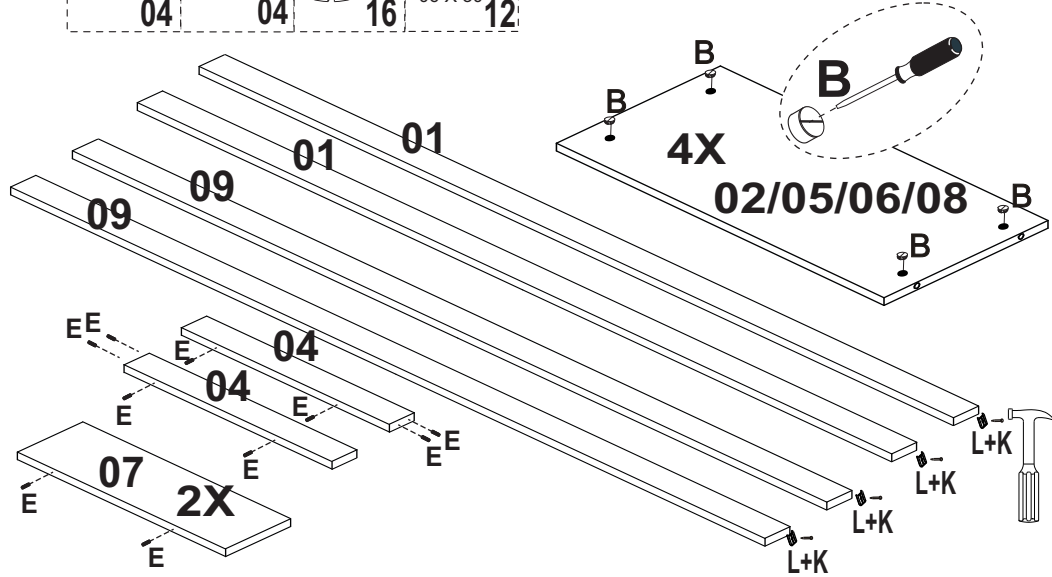
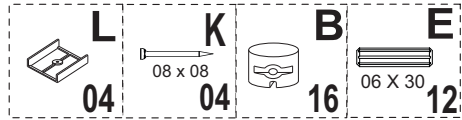

### Passo 02

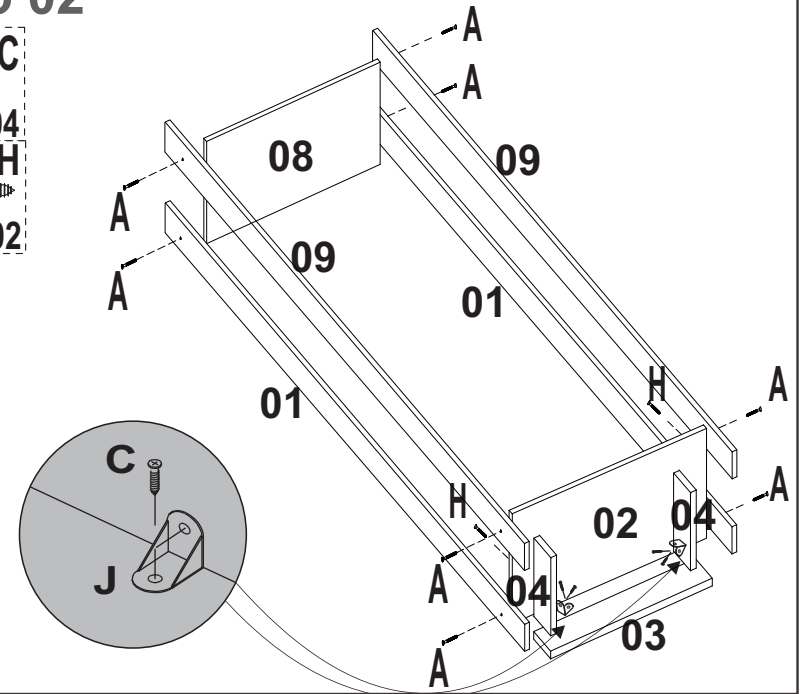
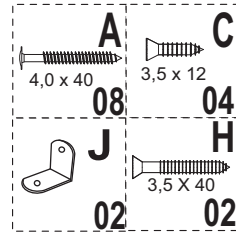

### Passo 03

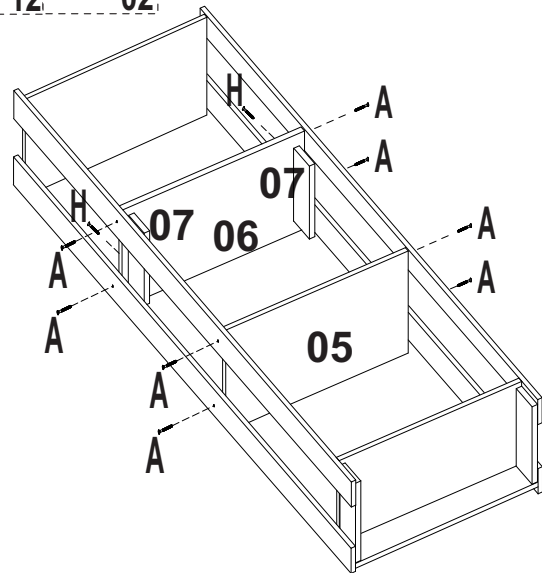
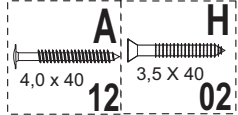

### Passo 04

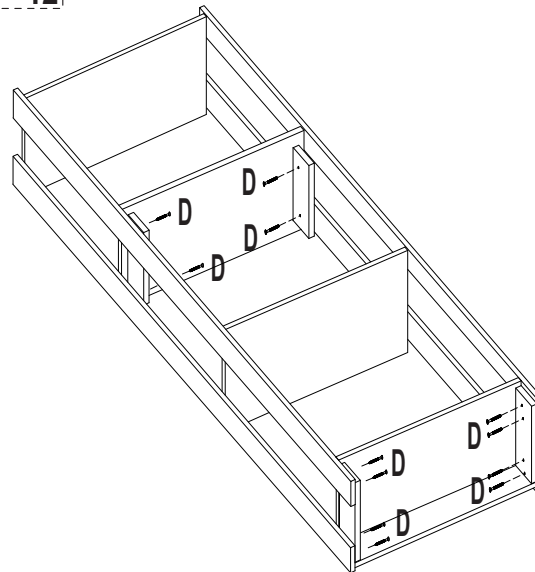
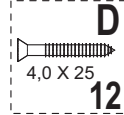

### Passo 05

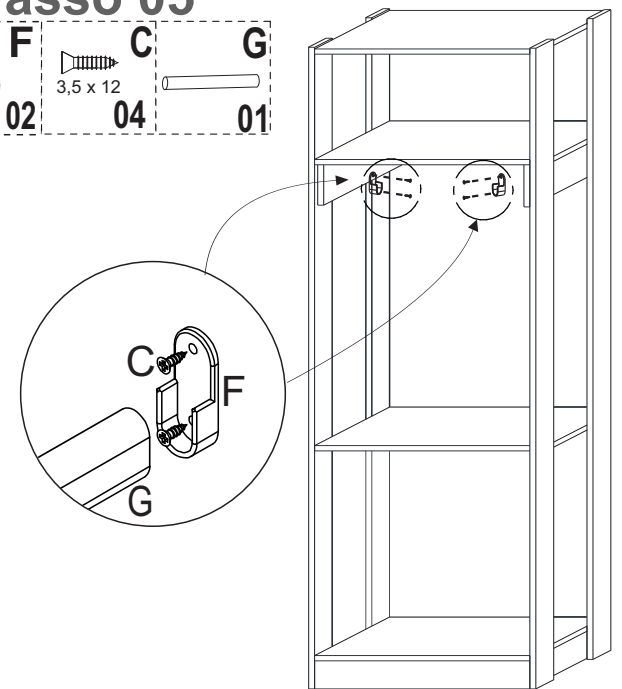







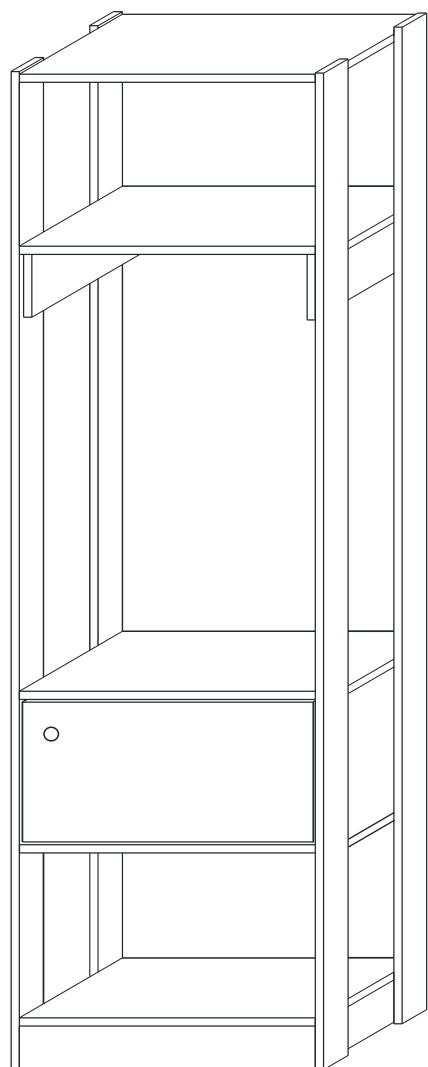



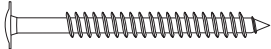

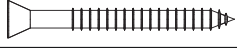
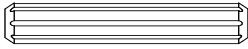
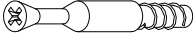

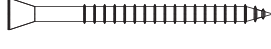
Av. Paranavaí, 3263  
 Pq. Cidade Industrial  
 Cep: 87070-130 - Maringá - PR  
 Fone - (44) 3225-2950 Fax - (44) 3262-9573  
 E-mail: moveisleao@moveisleao.com.br  
 Site: www.moveisleao.com.br

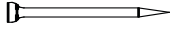

## Modulo TITAN (Porta)



N° PÇ	Descrição das peças	Qt.
1	Base da Porta	01
2	Lateral Esquerda do Nicho Porta	01
3	Lateral Direita do Nicho Porta	01
4	Porta	01
6	Fundo ( 53,5 x 32,5 x 03)	01
7	Batente da Porta	01

DESCRIÇÃO		QTD
<b>A</b>	 Parafuso 4,0 x 40	04
<b>B</b>	 Porca cilíndrica 9 x 12	04
<b>C</b>	 Parafuso 3,5 x 12	08
<b>D</b>	 Parafuso 4,0 x 25	10
<b>E</b>	 Cavilha 06 x 30	08
<b>F</b>	 Pino girofix simples	04
<b>G</b>	 Castanha girofix	04
<b>H</b>	 Parafuso 3,5 x 40	04
<b>I</b>	 Etiqueta	01
<b>J</b>	 Tampa castanha girofix	04
<b>K</b>	 Pregos 08 x 08	20
<b>L</b>	 Puxador	01
<b>M</b>	 Dobradiça	02
<b>N</b>	 Calço dobradiça	02
<b>O</b>	 Tampa adesiva	08
<b>P</b>	 Giz de Correção	02

PARA A LIMPEZA E CONSERVAÇÃO DO SEU MÓVEL

-  Não use produtos abrasivos como Álcool, Solventes, Acetona e etc...
-  Use somente um pano macio e seco.

DESEMBALANDO

Identifique todas as peças e deixe-as de pé, nunca coloque umas sobre as outras. Utilize a própria embalagem como tapete para a montagem do produto.

### Passo 01

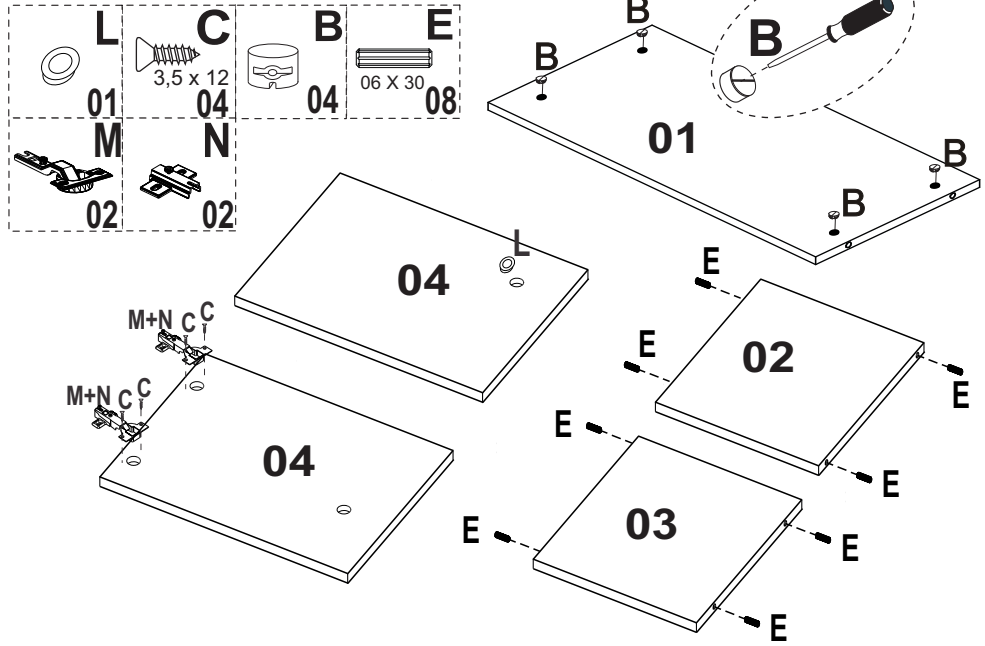

### Passo 02

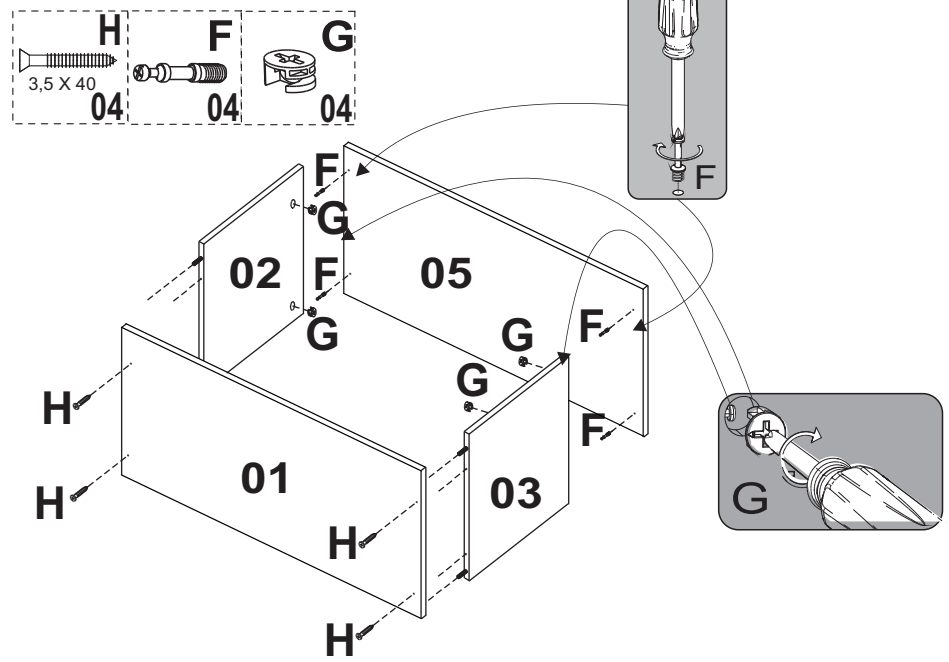

### Passo 03

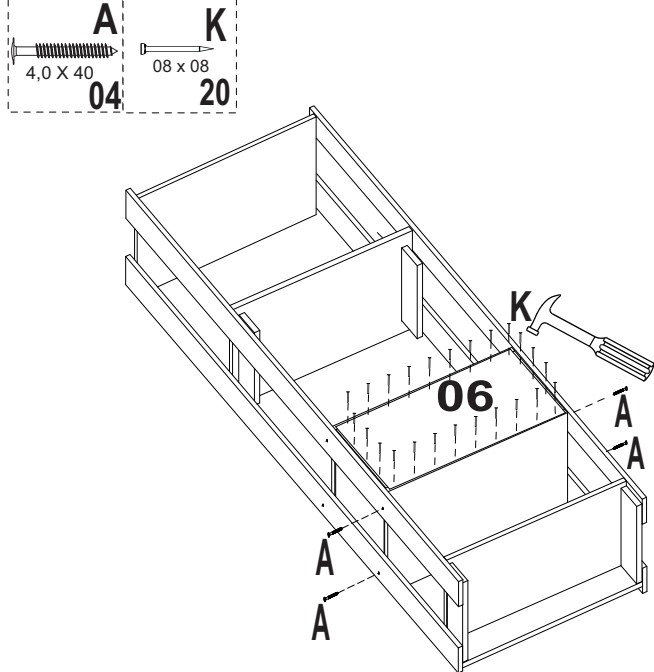

### Passo 04

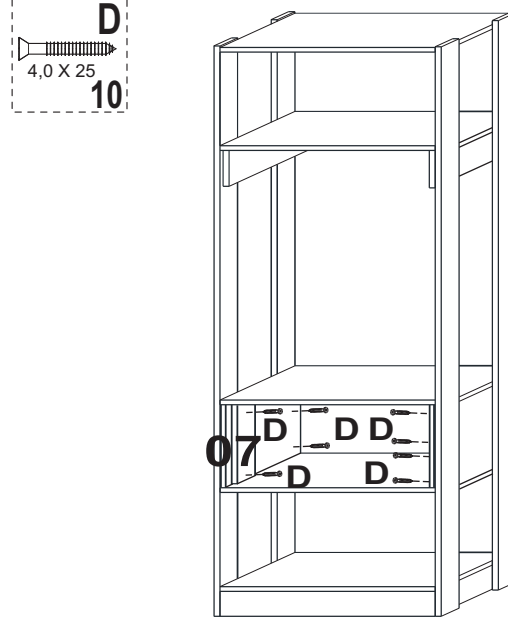



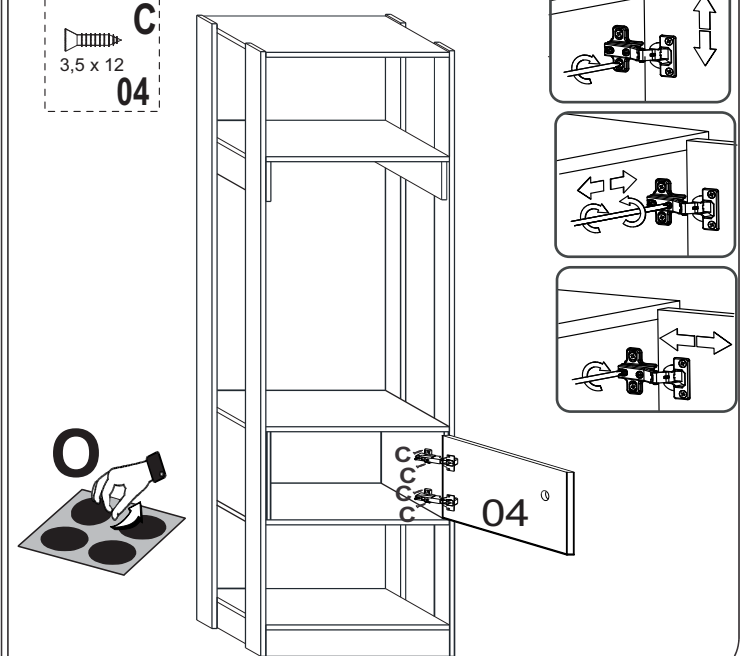

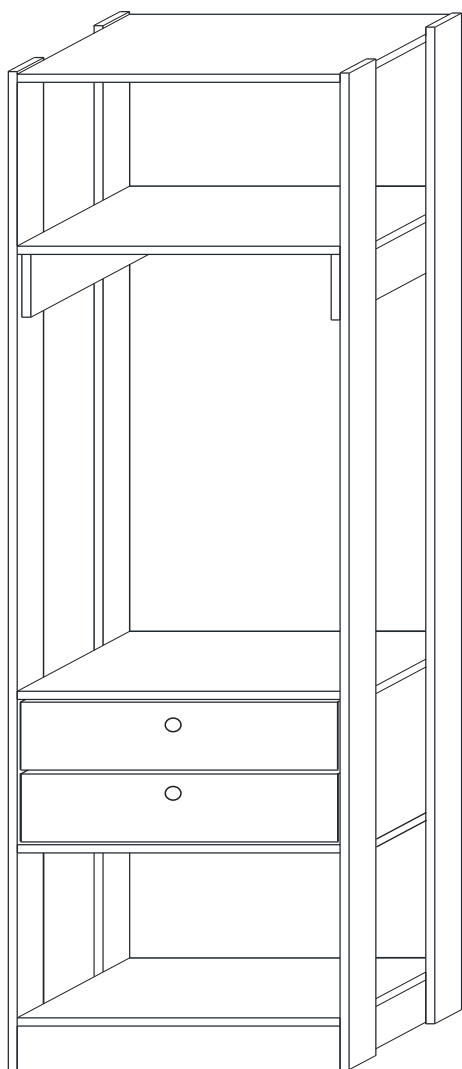





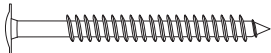

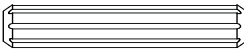

### Passo 05

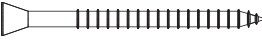

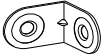



Nº PÇ	Descrição das peças	Qt.
1	Base	01
2	Lateral do Nicho Gaveta Esquerda	01
3	Lateral do Nicho Gaveta Direita	01
4	Frente de Gaveta	02
6	Lateral de Gaveta	04
7	Contra fundo de Gaveta	02
8	Fundo de Gaveta (48,0 x 35,8 x 03)	02
9	Fundo ( 53,5 x 32,5 x 03)	01

## Modulo TITAN (Gaveta)

	DESCRIÇÃO	QTD
<b>A</b>	 Parafuso 4,0 x 40	04
<b>B</b>	 Porca cilíndrica 9 x 12	08
<b>C</b>	 Parafuso 3,5 x 12	24
<b>D</b>	 Parafuso 4,0 x 25	08
<b>E</b>	 Cavilha 06 x 30	16
<b>F</b>	 Pino girofix simples	04
<b>G</b>	 Castanha girofix	04
<b>H</b>	 Parafuso 3,5 x 40	08
<b>I</b>	 Etiqueta	01
<b>J</b>	 Cantoneira	04
<b>K</b>	 Pregos 08 x 08	28
<b>L</b>	 Puxador	02
<b>M</b>	 Cola	01
<b>N</b>	 Corrediça Telescópica	02
<b>O</b>	 Giz de Correção	02

### PARA A LIMPEZA E CONSERVAÇÃO DO SEU MÓVEL

-  Não use produtos abrasivos como Álcool, Solventes, Acetona e etc...
-  Use somente um pano macio e seco.

### DESEMBALANDO

Identifique todas as peças e deixe-as de pé, nunca coloque umas sobre as outras. Utilize a própria embalagem como tapete para a montagem do produto.

## Passo 01

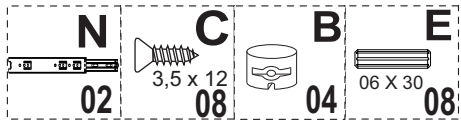

Separe as duas partes das corredeiras telescópicas, seguindo os seguintes passos:

- 1 - Abra toda a corredeira;
- 2 - Empurre a trava de segurança para cima;
- 3 - Mantenha a trava levantada e puxe a ponta da corredeira para frente.

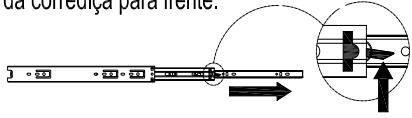

PARTE 01



A PRIMEIRA PARTE FIXA NAS LATERAIS

PARTE 02

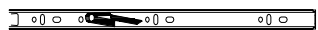

A SEGUNDA PARTE FIXA NA LATERAL DE GAVETA

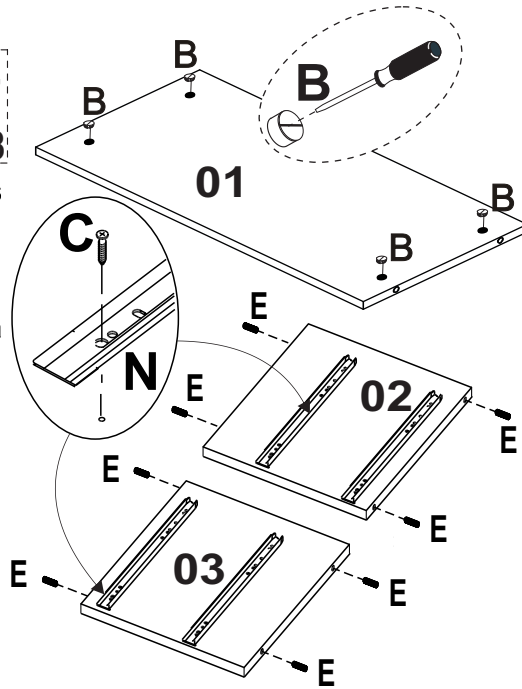

## Passo 02

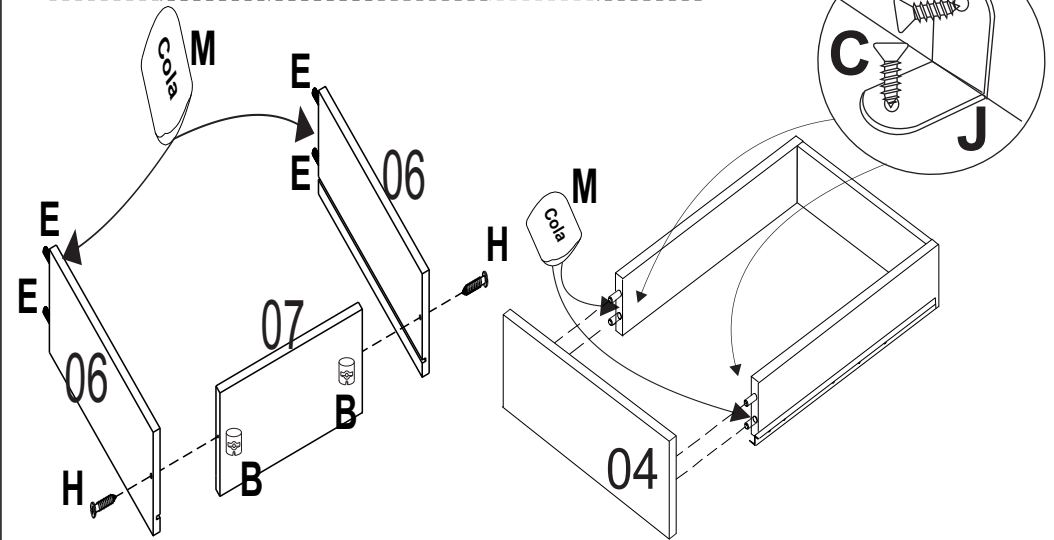
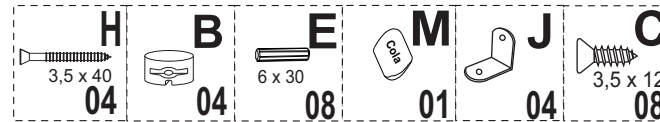

## Passo 03

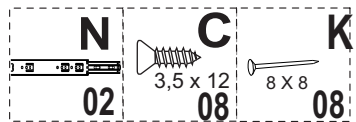

PARTE 02

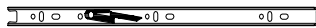

A SEGUNDA PARTE FIXE-A NA PARTE INFERIOR DA LATERAL DE GAVETA

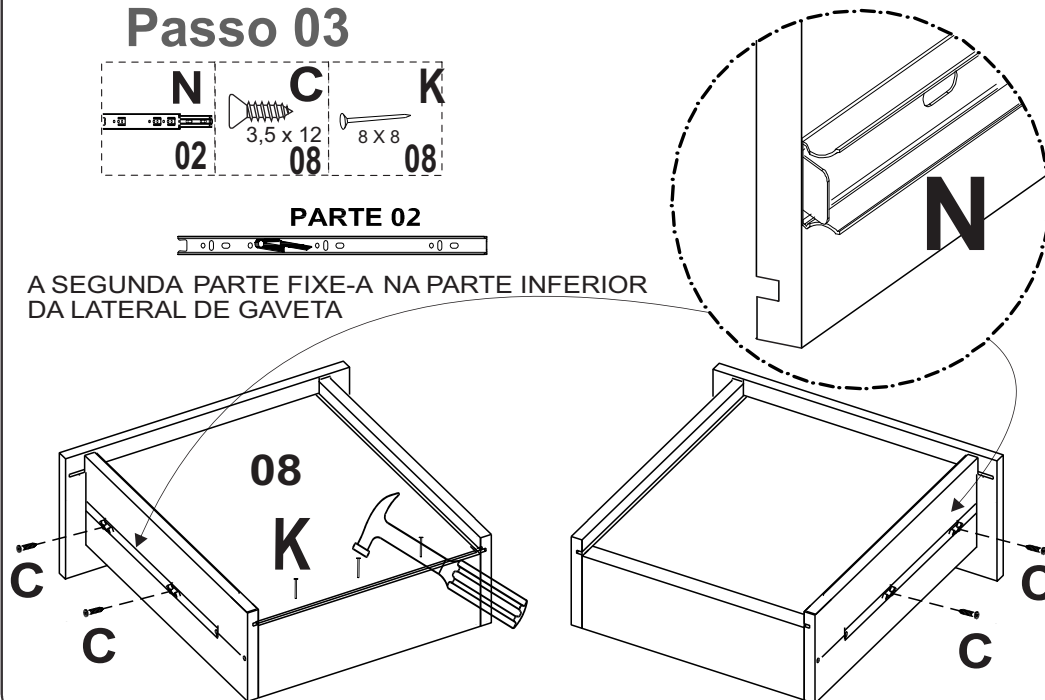

## Passo 04

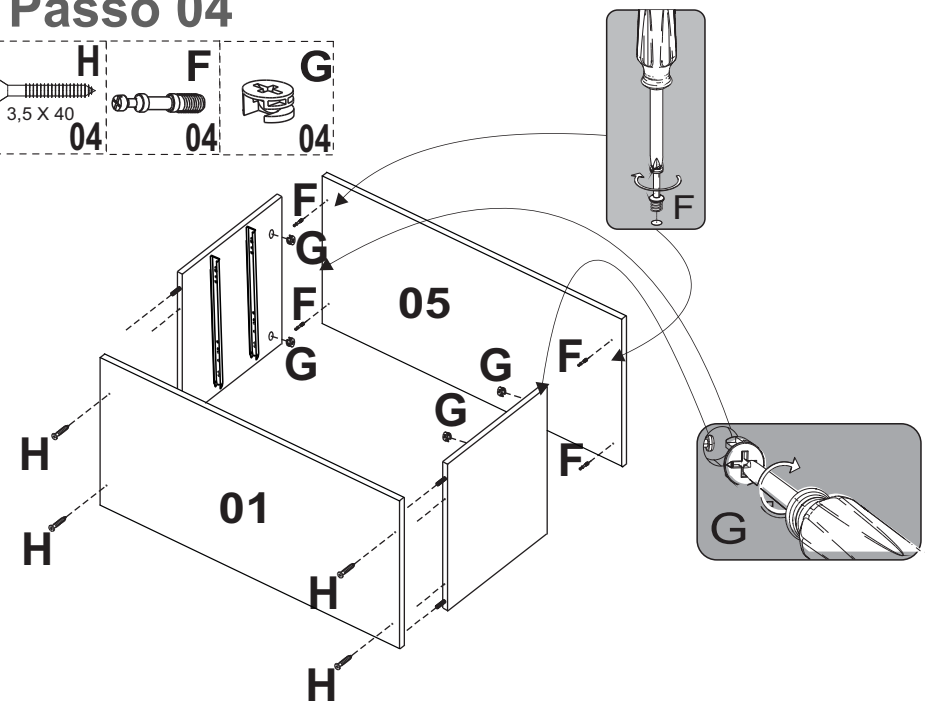
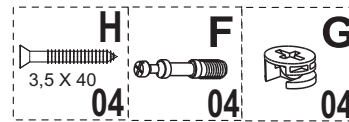

### Passo 05

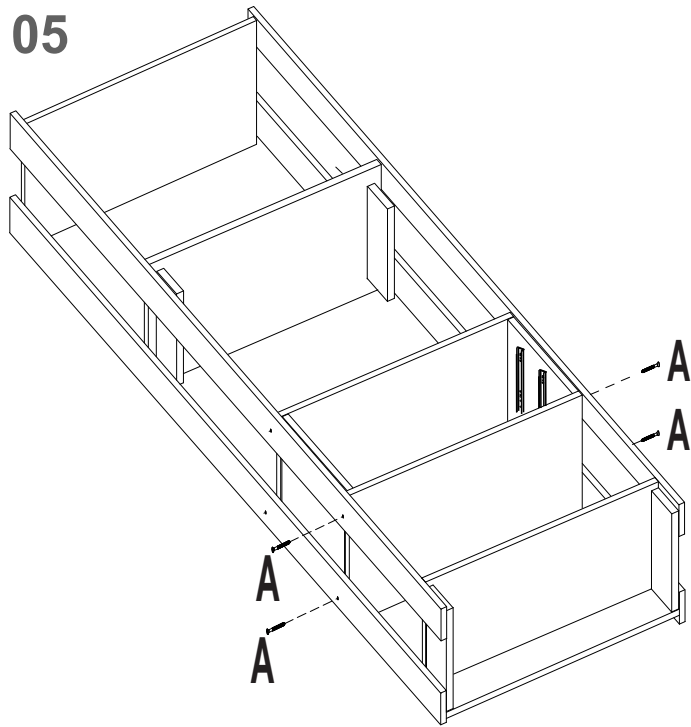
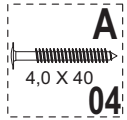

### Passo 06

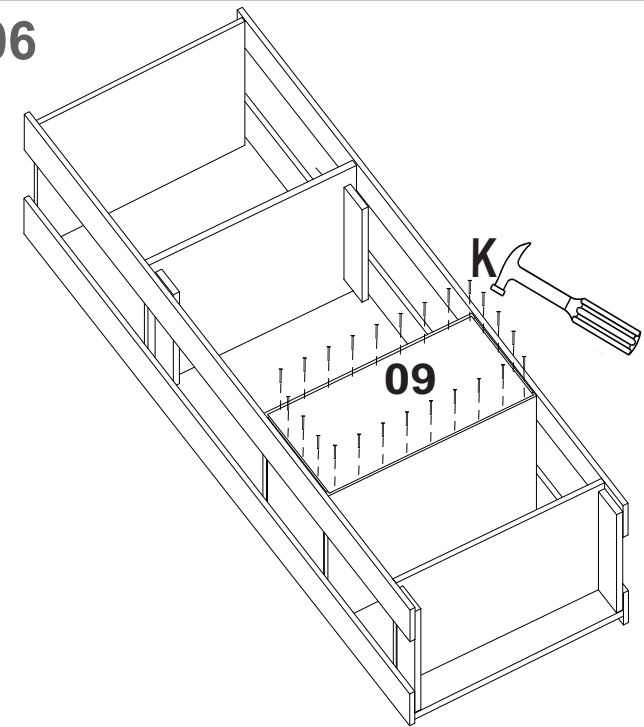
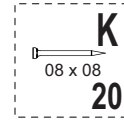

### Passo 07

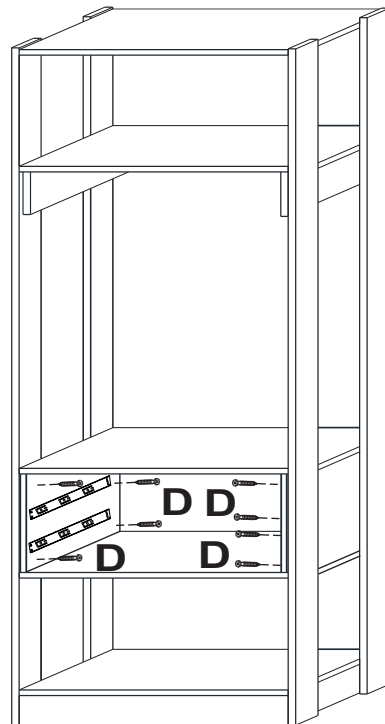
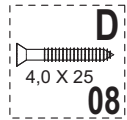

### Passo 08

